

### THREE PHASE AC SWITCH

### Power Modules

#### Features

- Package fully compatible with the industry standard INT-A-pak power modules series
- High thermal conductivity package, electrically insulated case
- Outstanding number of power encapsulated components
- Excellent power volume ratio
- 4000 V<sub>RMS</sub> isolating voltage
- UL E78996 approved 

50 A  
90 A  
100 A

#### Description

A range of extremely compact, encapsulated three phase AC-switches offering efficient and reliable operation. They are intended for use in general purpose and heavy duty applications as control motor starter.

#### Major Ratings and Characteristics

Parameters	54MT.KB	94MT.KB	104MT.KB	Units
$I_O$	50	90	100	A
@ $T_C$	80	80	80	°C
$I_{FSM}$ @ 50Hz	390	950	1130	A
@ 60Hz	410	1000	1180	A
$I^2t$ @ 50Hz	770	4525	6380	A <sup>2</sup> s
@ 60Hz	700	4130	5830	A <sup>2</sup> s
$I^2\sqrt{t}$	7700	45250	63800	A <sup>2</sup> √s
$V_{RRM}$ range	800 to 1600			V
$T_{STG}$ range	-40 to 125			°C
$T_J$ range	-40 to 125			°C

## 54-94-104MT..KB Series

Bulletin I27504 08/97

International  
IRF Rectifier

### ELECTRICAL SPECIFICATIONS

#### Voltage Ratings

Type number	Voltage Code	$V_{RRM}$ , maximum repetitive peak reverse voltage V	$V_{RSM}$ , maximum non-repetitive peak reverse voltage V	$V_{DRM}$ , max. repetitive peak off-state voltage, gate open circuit V	$I_{RRM}/I_{DRM}$ max. @ $T_J = 125^\circ\text{C}$ mA
54MT..KB	80	800	900	800	20 *
	100	1000	1100	1000	
	120	1200	1300	1200	
	140	1400	1500	1400	
	160	1600	1700	1600	
94/104MT..KB	80	800	900	800	40 *
	100	1000	1100	1000	
	120	1200	1300	1200	
	140	1400	1500	1400	
	160	1600	1700	1600	

\* For single AC switch

#### Forward Conduction

Parameter	54MT.KB	94MT.KB	104MT.KB	Units	Conditions		
$I_O$ Maximum $I_{RMS}$ output current @ Case temperature	50	90	100	A	For all conduction angle		
	80	80	80	$^\circ\text{C}$			
$I_{TSM}$ Maximum peak, one-cycle forward, non-repetitive on state surge current	390	950	1130	A	t = 10ms	No voltage reappplied	Initial $T_J = T_{J \text{ max.}}$
	410	1000	1180		t = 8.3ms	reappplied	
	330	800	950		t = 10ms	100% $V_{RRM}$	
	345	840	1000		t = 8.3ms	reappplied	
$I^2t$ Maximum $I^2t$ for fusing	770	4525	6380	$\text{A}^2\text{s}$	t = 10ms	No voltage reappplied	$T_J = T_{J \text{ max.}}$
	700	4130	5830		t = 8.3ms	reappplied	
	540	3200	4510		t = 10ms	100% $V_{RRM}$	
	500	2920	4120		t = 8.3ms	reappplied	
$I^2\sqrt{t}$ Maximum $I^2\sqrt{t}$ for fusing	7700	45250	63800	$\text{A}^2\sqrt{\text{s}}$	t = 0.1 to 10ms, no voltage reappplied		
$V_{T(TO)1}$ Low level value of threshold voltage	1.16	0.99	0.99	V	$(16.7\% \times \pi \times I_{T(AV)} < I < \pi \times I_{T(AV)})$ , @ $T_J \text{ max.}$		
$V_{T(TO)2}$ High level value of threshold voltage	1.44	1.19	1.15	V	$(I > \pi \times I_{T(AV)})$ , @ $T_J \text{ max.}$		
$r_{T1}$ Low level value on-state slope resistance	12.54	4.16	3.90	$\text{m}\Omega$	$(16.7\% \times \pi \times I_{T(AV)} < I < \pi \times I_{T(AV)})$ , @ $T_J \text{ max.}$		
$r_{T2}$ High level value on-state slope resistance	11.00	3.56	3.48	$\text{m}\Omega$	$(I > \pi \times I_{T(AV)})$ , @ $T_J \text{ max.}$		
$V_{TM}$ Maximum on-state voltage drop	2.68	1.55	1.53	V	$I_{pk} = 150\text{A}$ , $T_J = 25^\circ\text{C}$ $t_p = 400\mu\text{s}$ single junction		
$di/dt$ Max. non-repetitive rate of rise of turned on current	150			$\text{A}/\mu\text{s}$	$T_J = 25^\circ\text{C}$ , from 0.67 $V_{DRM}$ , $I_{TM} = \pi \times I_{T(AV)}$ , $I_g = 500\text{mA}$ , $t_r < 0.5\mu\text{s}$ , $t_p > 6\mu\text{s}$		
$I_H$ Max. holding current	200			mA	$T_J = 25^\circ\text{C}$ , anode supply = 6V, resistive load, gate open circuit		
$I_L$ Max. latching current	400				$T_J = 25^\circ\text{C}$ , anode supply = 6V, resistive load		

**Blocking**

Parameter	54MT.KB	94MT.KB	104MT.KB	Units	Conditions
V <sub>INS</sub> RMS isolation voltage	4000			V	T <sub>J</sub> = 25°C all terminal shorted f = 50Hz, t = 1s
dv/dt Max. critical rate of rise of off-state voltage (*)	500			V/μs	T <sub>J</sub> = T <sub>J</sub> max., linear to 0.67 V <sub>DRM</sub> gate open circuit

(\*) Available with dv/dt = 1000V/μs, to complete code add S90 i.e. 104MT160KBS90.

**Triggering**

Parameter	54MT.KB	94MT.KB	104MT.KB	Units	Conditions
P <sub>GM</sub> Max. peak gate power	10			W	T <sub>J</sub> = T <sub>J</sub> max.
P <sub>G(AV)</sub> Max. average gate power	2.5				
I <sub>GM</sub> Max. peak gate current	2.5			A	
-V <sub>GT</sub> Max. peak negative gate voltage	10			V	
V <sub>GT</sub> Max. required DC gate voltage to trigger	4.0			V	T <sub>J</sub> = - 40°C
	2.5				T <sub>J</sub> = 25°C
	1.7				T <sub>J</sub> = 125°C
I <sub>GT</sub> Max. required DC gate current to trigger	270			mA	T <sub>J</sub> = - 40°C
	150				T <sub>J</sub> = 25°C
	80				T <sub>J</sub> = 125°C
V <sub>GD</sub> Max. gate voltage that will not trigger	0.25			V	@ T <sub>J</sub> = T <sub>J</sub> max., rated V <sub>DRM</sub> applied
I <sub>GD</sub> Max. gate current that will not trigger	6			mA	

**Thermal and Mechanical Specifications**

Parameter	54MT.KB	94MT.KB	104MT.KB	Units	Conditions
T <sub>J</sub> Max. junction operating temperature range	-40 to 125			°C	
T <sub>stg</sub> Max. storage temperature range	-40 to 125			°C	
R <sub>thJC</sub> Max. thermal resistance, junction to case	0.52	0.39	0.34	K/W	DC operation per single AC switch
	1.05	0.77	0.69		DC operation per junction
	0.56	0.40	0.36		180° Sine cond. angle per single AC switch
	1.12	0.80	0.72		180° Sine cond. angle per junction
R <sub>thCS</sub> Max. thermal resistance, case to heatsink	0.03			K/W	Per module Mounting surface smooth, flat and greased
T Mounting torque ± 10%	to heatsink	4 to 6		Nm	A mounting compound is recommended and the torque should be rechecked after a period of 3 hours to allow for the spread of the compound. Lubricated threads.
	to terminal	3 to 4			
wt Approximate weight	225			g	

## 54-94-104MT..KB Series

Bulletin I27504 08/97

International  
**IRF** Rectifier

### ΔR Conduction (per Junction)

(The following table shows the increment of thermal resistance  $R_{thJC}$  when devices operate at different conduction angles than DC)

Devices	Sinusoidal conduction @ $T_J$ max.					Rectangular conduction @ $T_J$ max.					Units
	180°	120°	90°	60°	30°	180°	120°	90°	60°	30°	
54MT.KB	0.072	0.085	0.108	0.152	0.233	0.055	0.091	0.117	0.157	0.236	K/W
94MT.KB	0.033	0.039	0.051	0.069	0.099	0.027	0.044	0.055	0.071	0.100	
104MT.KB	0.027	0.033	0.042	0.057	0.081	0.023	0.037	0.046	0.059	0.082	

### Ordering Information Table

Device Code						
10	4	MT	160	K	B	S90
①	②	③	④	⑤	⑥	
<b>1</b>	- Current rating code: 5 = 50 A (Avg) 9 = 90 A (Avg) 10 = 100 A (Avg)					
<b>2</b>	- AC Switch					
<b>3</b>	- Essential part number					
<b>4</b>	- Voltage code: Code x 10 = $V_{RRM}$ (See Voltage Ratings Table)					
<b>5</b>	- Generation II					
<b>6</b>	- Critical dv/dt: None = 500V/μs (Standard value) S90 = 1000V/μs (Special selection)					

**NOTE: To order the Optional Hardware see Bulletin I27900**

Outline Table (with optional barriers)

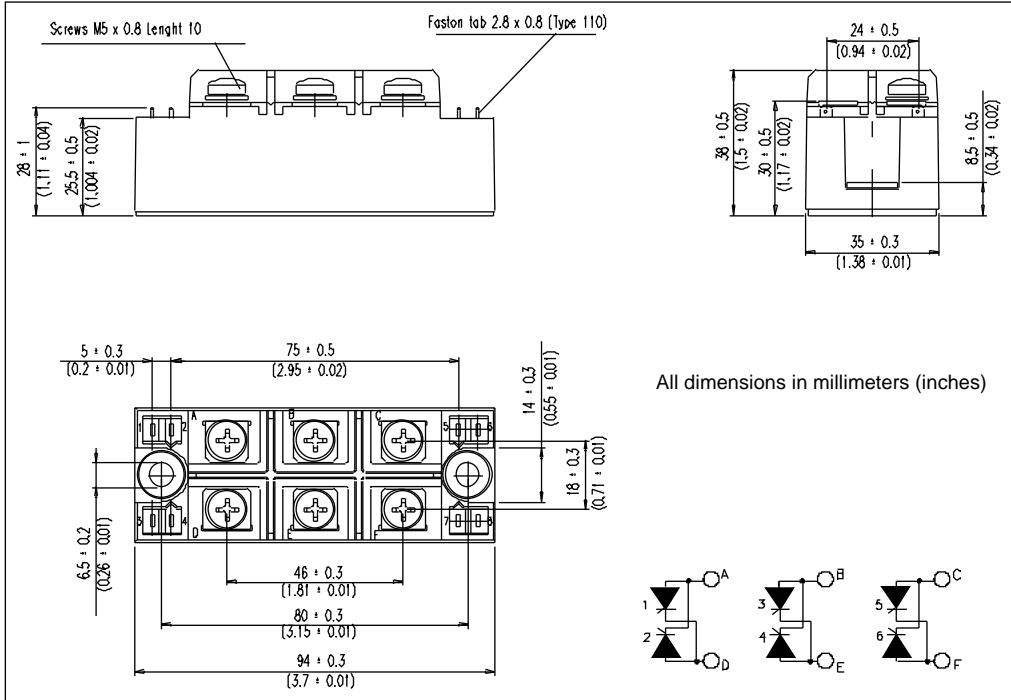

Outline Table (without optional barriers)

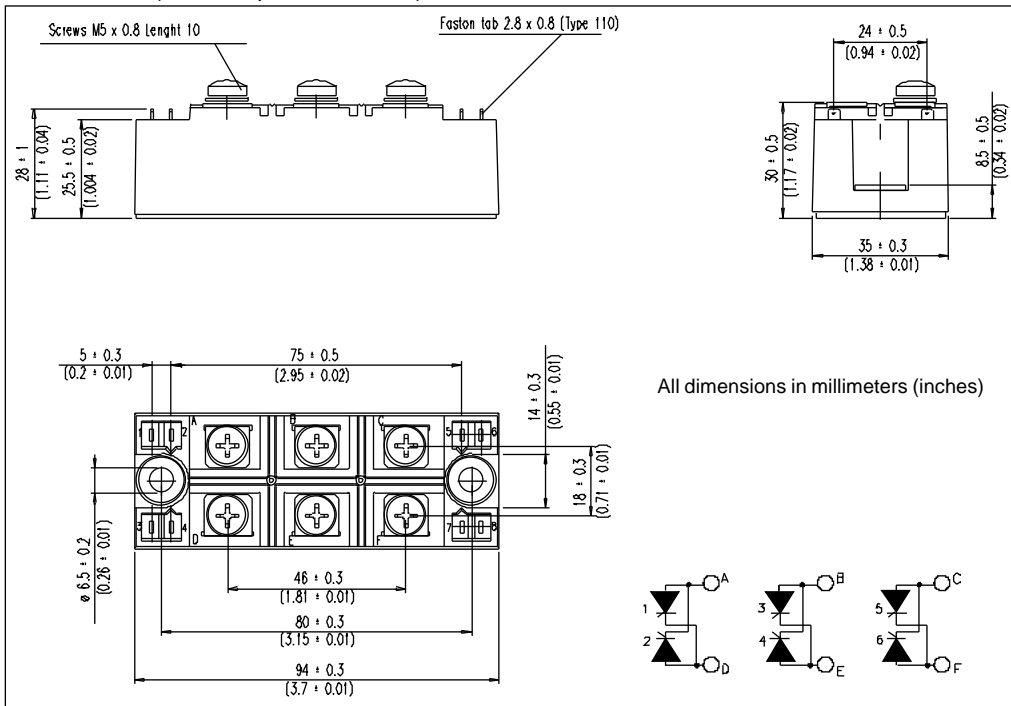

## GATE LEADS

Ident No.	Device Series	Description
6443.2112.AA	51, 91, 111MT..KB	2 DX connectors with yellow and white leads
6443.2113.AA	52, 92, 112MT..KB	1 SX + 1 DX connectors with yellow and white leads
6443.2114.AA	53, 93, 113MT..KB 54, 94, 104MT..KB	1 SX + 2 DX connectors with yellow and white leads

### Components

- 1) Tinned copper stranded cable, UL 758, Style 1558, AWG 22 (0.32 sqmm) lay 19 x 0.16, ETFE insulation yellow colour, ext. dia. 1.25 mm, temp. rating 125°C.
- 2) Same as point 1, but with white colour insulation. Concerning the configurations in which white cable is requested, it must be connected where is not placed the polarization key.
- 3) Receptacle faston terminal with locking lance, for 2.8 x 0.8 tab (series 110) ref. PN. AMP 150571-2 or equivalent.
- 4) 2 ways polarized connector housing, as shown on dimensional detail (the represented version refers to left 'SX' conn. housing). Raw material: PBT Ciba Crastine SK645FR, black colour.
- 5) Connector housing as point 4), right 'DX' version.

2 ways polarized connector housing, dimensional detail.

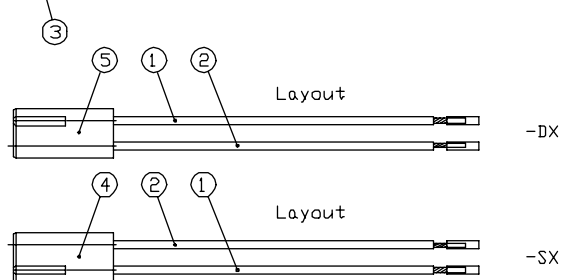
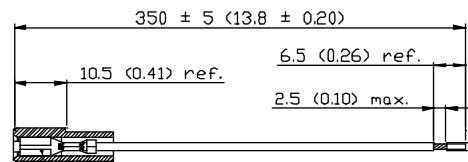
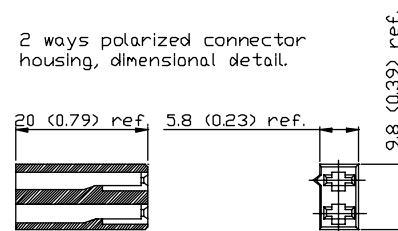

All dimensions are in millimeters (inches)

## BARRIERS

**Ident No. 6444.0211.AA** for all MT..KB Series

**Barriers Mounting Instructions**  
 Coat uniformly the groove on the plastic box with a silicon adhesive. Insert the barriers into the groove on the plastic box. Cure the silicon adhesive according to its technical notes. We suggest the use of DOW CORNING Silastic 744RTV (time curing 30 min. at room temperature).

All dimensions are in millimeters (inches)

# 54-94-104MT..KB Series

Bulletin I27504 08/97

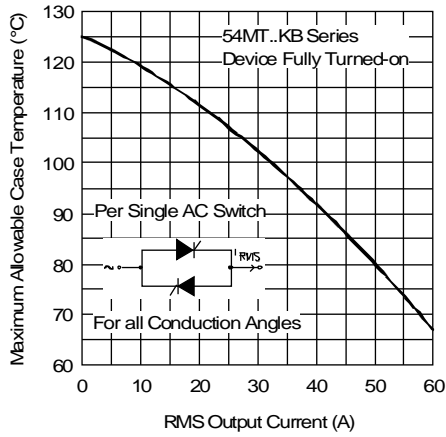

Fig. 1 - Current Ratings Characteristic

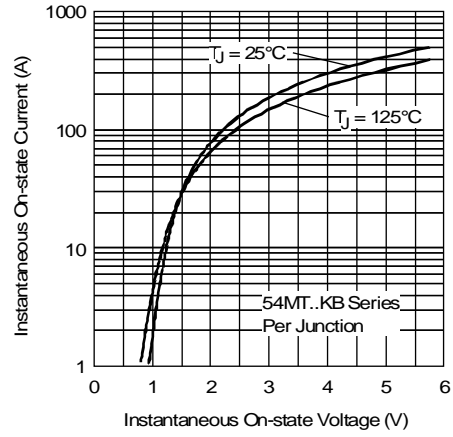

Fig. 2 - Forward Voltage Drop Characteristics

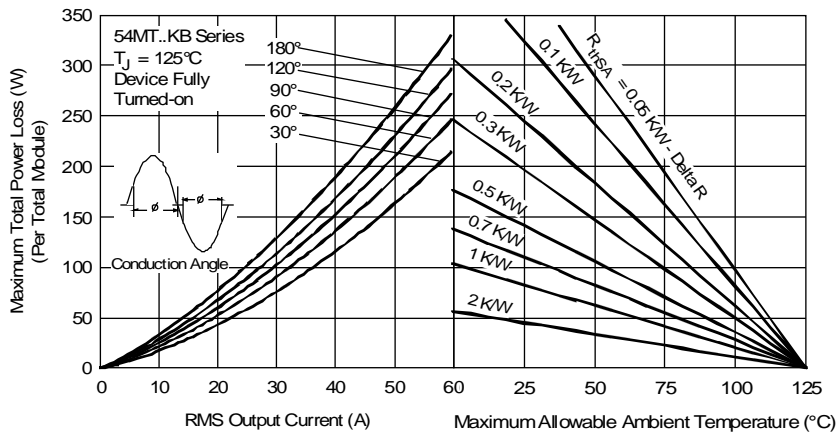

Fig. 3 - Total Power Loss Characteristics

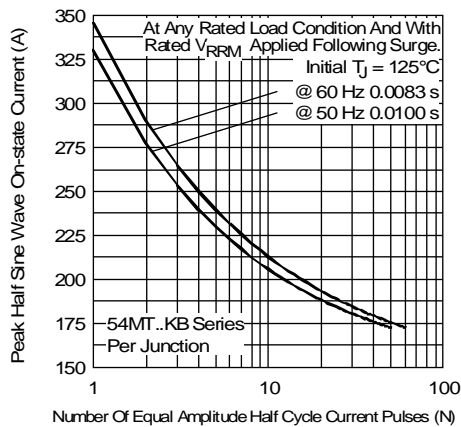

Fig. 4 - Maximum Non-Repetitive Surge Current

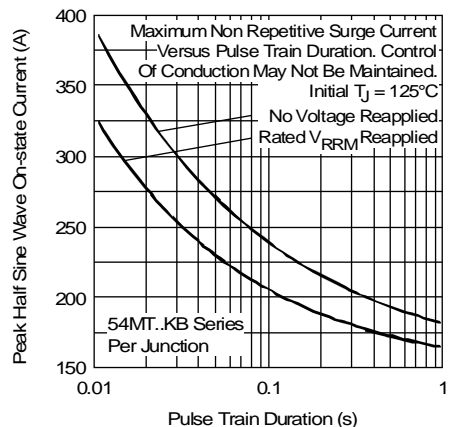

Fig. 5 - Maximum Non-Repetitive Surge Current

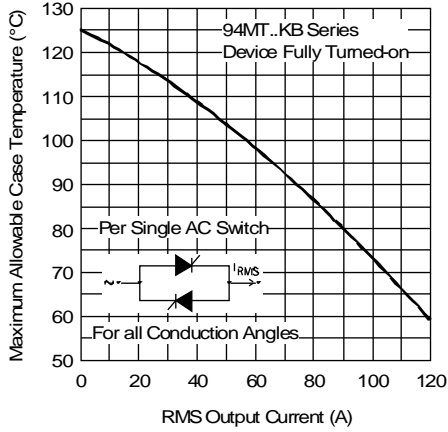

Fig. 6 - Current Ratings Characteristic

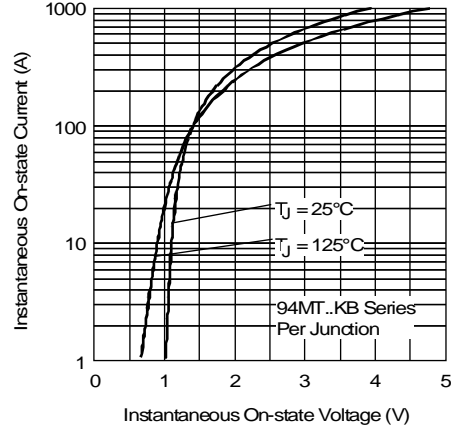

Fig. 7 - Forward Voltage Drop Characteristics

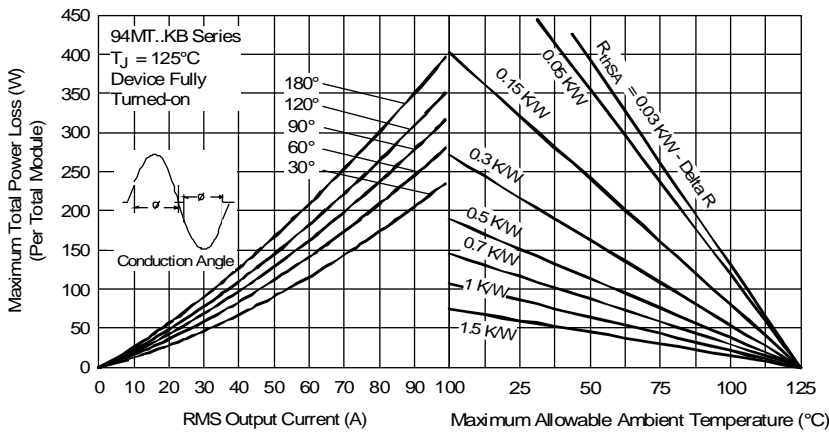

Fig. 8 - Total Power Loss Characteristics

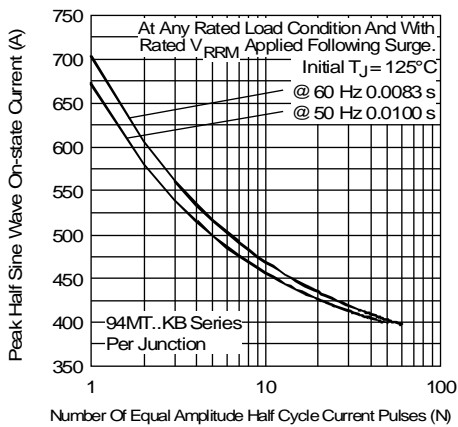

Fig. 9 - Maximum Non-Repetitive Surge Current

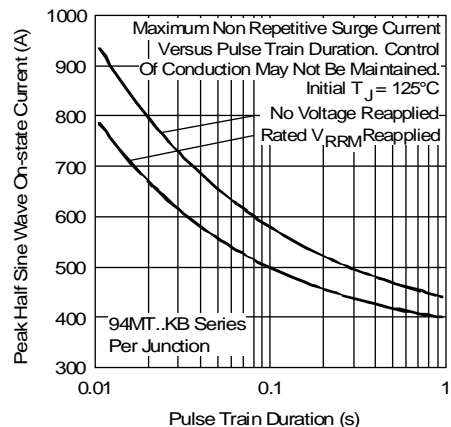

Fig. 10 - Maximum Non-Repetitive Surge Current



# 54-94-104MT..KB Series

Bulletin I27504 08/97

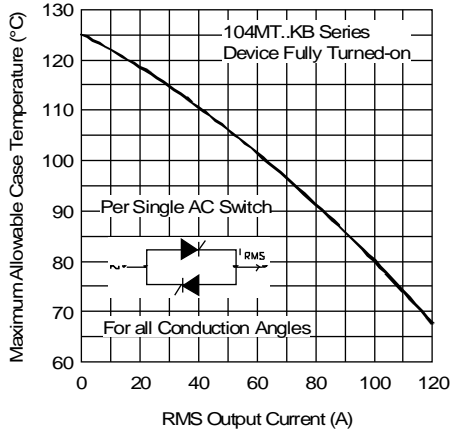

Fig. 11 - Current Ratings Characteristic

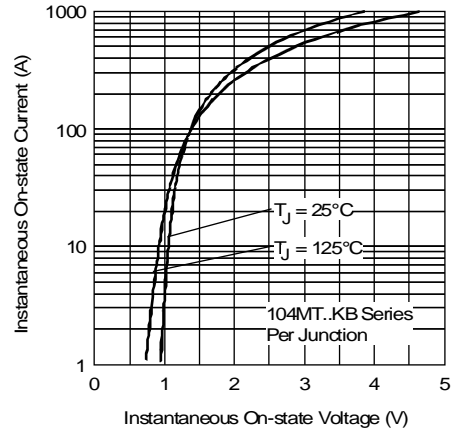

Fig. 12 - Forward Voltage Drop Characteristics

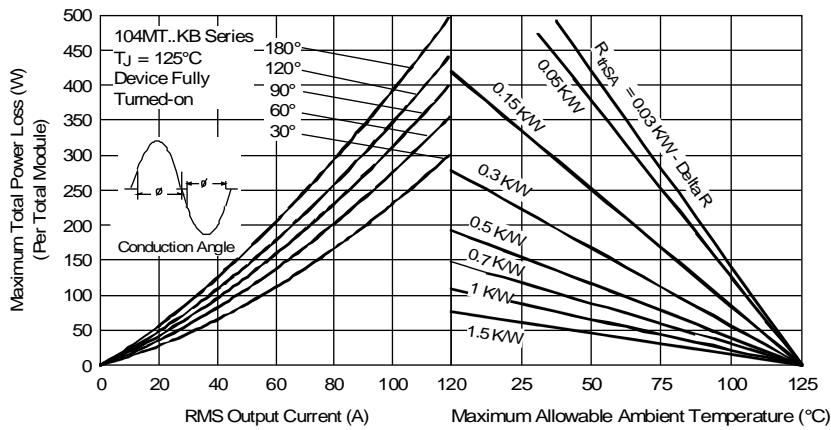

Fig. 13 - Total Power Loss Characteristics

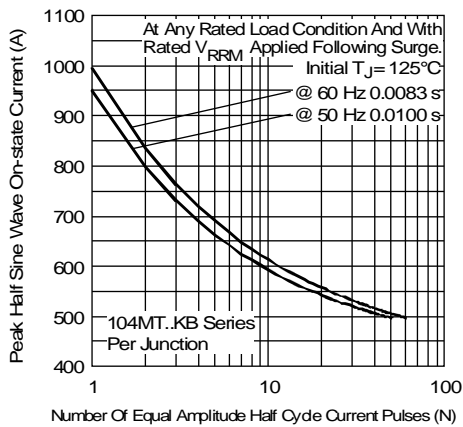

Fig. 14 - Maximum Non-Repetitive Surge Current

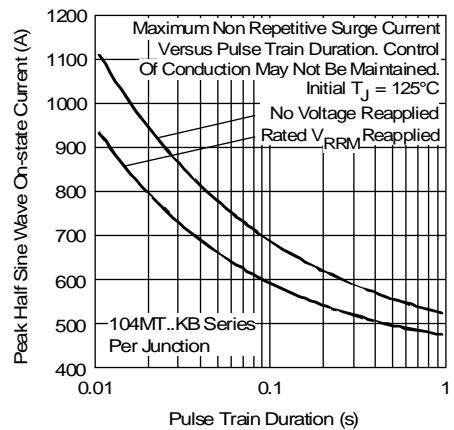

Fig. 15 - Maximum Non-Repetitive Surge Current

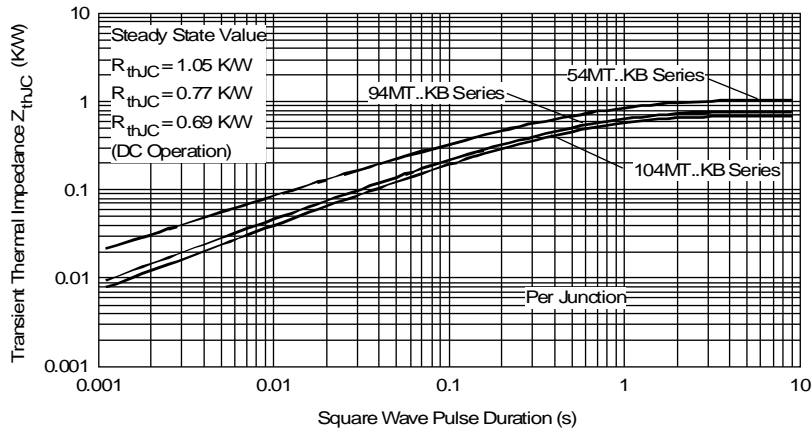

Fig. 16 - Thermal Impedance  $Z_{thJC}$  Characteristics

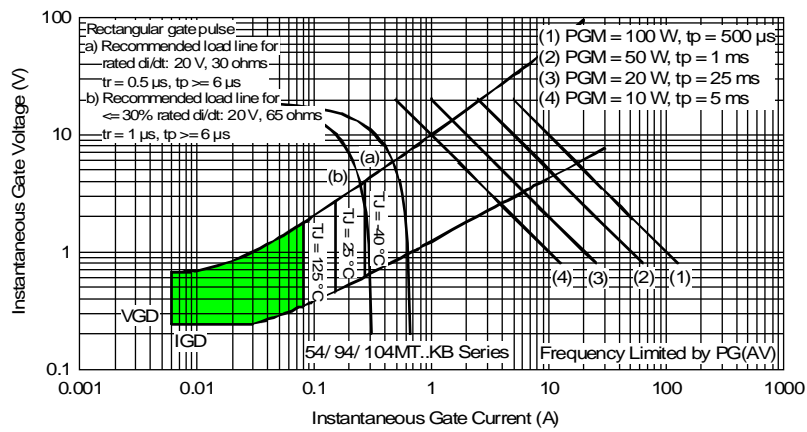

Fig. 17 - Gate Characteristics