

### STANDARD RECOVERY DIODES

Stud Version

#### Features

- Diffused diode
- High voltage ratings up to 1200V
- High surge current capabilities
- Stud cathode and stud anode version
- Hermetic metal case

150A

#### Typical Applications

- Welders
- Power supplies
- Machine tool controls
- High power drives
- Medium traction applications
- Battery charges
- Free-wheeling diodes

#### Major Ratings and Characteristics

Parameters	150U(R)..	Units
$I_{F(AV)}$	150	A
@ $T_C$	125	°C
$I_{F(RMS)}$	235	A
$I_{FSM}$ @ 50Hz	3000	A
@ 60Hz	3140	A
$I^2t$ @ 50Hz	45	KA <sup>2</sup> s
@ 60Hz	41	KA <sup>2</sup> s
$V_{RRM}$ range	600 and 1200	V
$T_J$	- 40 to 180	°C

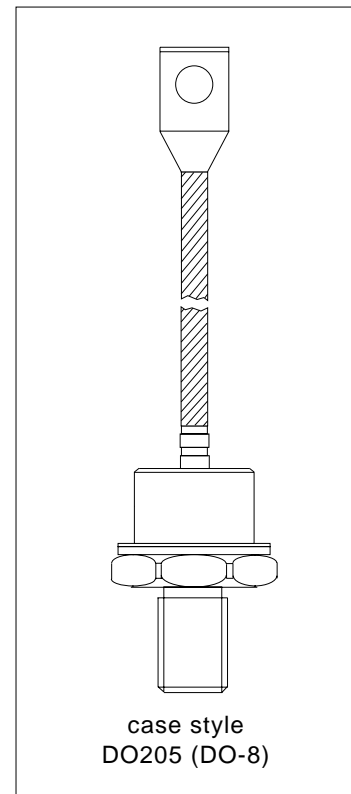

## 150U(R).. Series

Bulletin I2025 rev. D 03/03

International  
IR Rectifier

### ELECTRICAL SPECIFICATIONS

#### Voltage Ratings

Type number	Voltage Code	$V_{RRM}$ , maximum repetitive peak reverse voltage V	$V_{RSM}$ , maximum non-repetitive peak rev. voltage V	$I_{RRM}$ max. @ $T_J = T_J$ max. mA
150U(R)..	60	600	700	15
	80	800	900	
	100	1000	1100	
	120	1200	1300	

#### Forward Conduction

Parameter	150U(R)..	Units	Conditions		
$I_{F(AV)}$ Max. average forward current @ Case temperature	150	A	180° conduction, half sine wave		
	125	°C			
$I_{F(RMS)}$ Max. RMS forward current	235	A	Dc @ 110°C		
$I_{FSM}$ Max. peak, one-cycle forward, non-repetitive surge current	3000	A	t = 10ms	No voltage reapplied	Sinusoidal half wave, Initial $T_J = T_J$ max.
	3140		t = 8.3ms		
$I^2t$ Maximum $I^2t$ for fusing	45	KA <sup>2</sup> s	t = 10ms	No voltage reapplied	
	41		t = 8.3ms		
$r_f$ Slope resistance	0.97	mΩ	@ $T_J = T_J$ max.		
$V_{F(T0)}$ Threshold voltage	0.80	V			
$V_{FM}$ Max. forward voltage drop	1.47	V	$I_{pk} = 600A$ , $T_J = 25°C$ , $t_p = 10ms$ sinusoidal wave		

#### Thermal and Mechanical Specifications

Parameter	150U(R)..	Units	Conditions
$T_J$ Max. junction operating temperature range	-40 to 180	°C	
$T_{stg}$ Max. storage temperature range	-40 to 180		
$R_{thJC}$ Max. thermal resistance, junction to case	0.3	K/W	DC operation
$R_{thCS}$ Max. thermal resistance, case to heatsink	0.1		Mounting surface, smooth, flat and greased
T Max. allowed mounting torque +0 -20%	17	Nm	Not lubricated threads
	14.5		Lubricated threads
wt Approximate weight	130	g	
Case style	DO-205 (DO-8)		See Outline Table

#### $\Delta R_{thJC}$ Conduction

(The following table shows the increment of thermal resistance  $R_{thJC}$  when devices operate at different conduction angles than DC)

Conduction angle	Sinusoidal conduction	Rectangular conduction	Units	Conditions
180°	0.031	0.023	K/W	$T_J = T_J$ max.
120°	0.038	0.040		
90°	0.048	0.053		
60°	0.071	0.075		
30°	0.120	0.121		

Ordering Information Table

Device Code						
15	0	U	R	120	D	L
(1)	(2)	(3)	(4)	(5)	(6)	(7)

- 1** - 15 = Essential Part Number
- 2** - 0 = Standard Device
- 3** - U = Stud Normal Polarity (Cathode to Stud)
- 4** - None = Stud Normal Polarity (Cathode to Stud)  
 R = Stud Reverse Polarity (Anode to Stud)
- 5** - Voltage code: Code x 10 =  $V_{RRM}$  (See Voltage Ratings table)
- 6** - Diffused diode
- 7** - L = Stud base 1/2" - 20UNF-2A threads  
 None = Stud base 3/8" - 24UNF-2A threads

NOTE: For Metric Device M12 x 1.75 Contact Factory

Outline Table

**GLASS-METAL SEAL**

16.5 (0.65) MAX.

6.5 (0.26) MIN.

2.6 (0.10) MAX.

35 (1.38) MAX.

DIA. 8.5 (0.33) NOM.

C.S. 16mm<sup>2</sup> (0.015 s.i.)

165 (6.49) MIN.

170 (6.69) MAX.

55 (2.16) MIN.

DIA. 23.5 (0.93) MAX.

24 (0.94) MAX.

17 (0.69) MAX.

3/8"-24UNF-2A \*

**150U(R) Series**  
 Conforms to JEDEC DO-205 (DO-8)  
 All dimensions in millimeters (inches)

\* FOR METRIC DEVICE M12 x 1.75  
 \* FOR STUD BASE 1/2" - 20UNF-2A THREADS; refer "Ordering Information Table"

# 150U(R).. Series

Bulletin I2025 rev. D 03/03

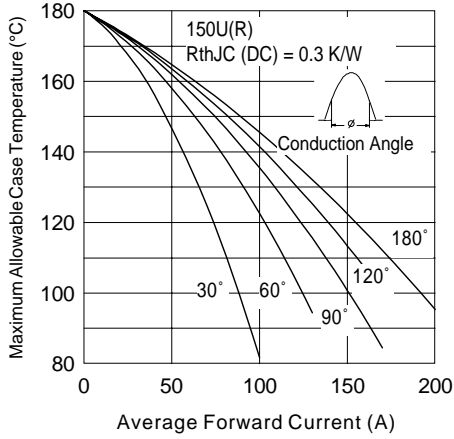

Fig. 1 - Current Ratings Characteristics

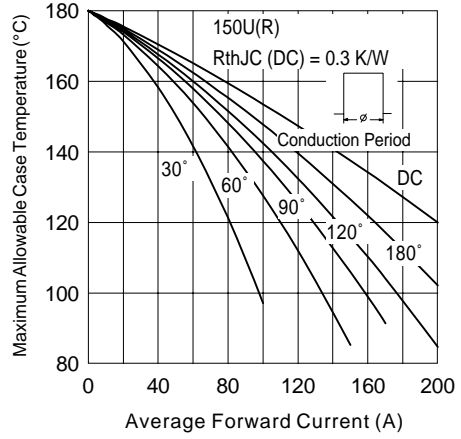

Fig. 2 - Current Ratings Characteristics

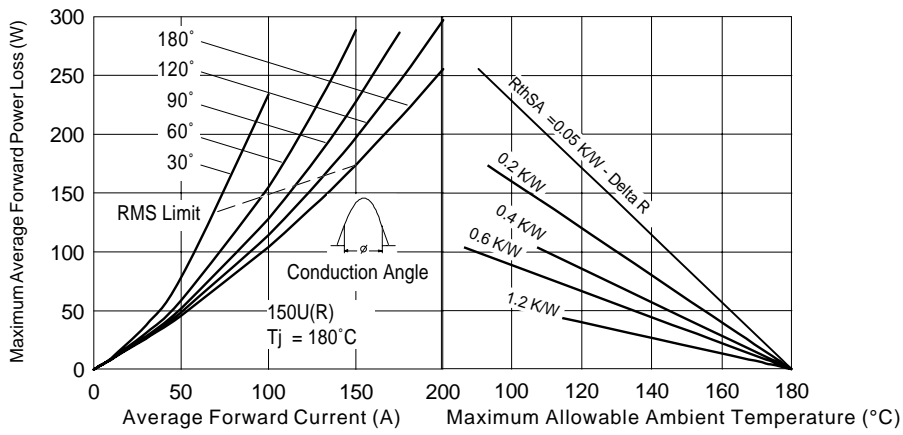

Fig. 3 - Forward Power Loss Characteristics

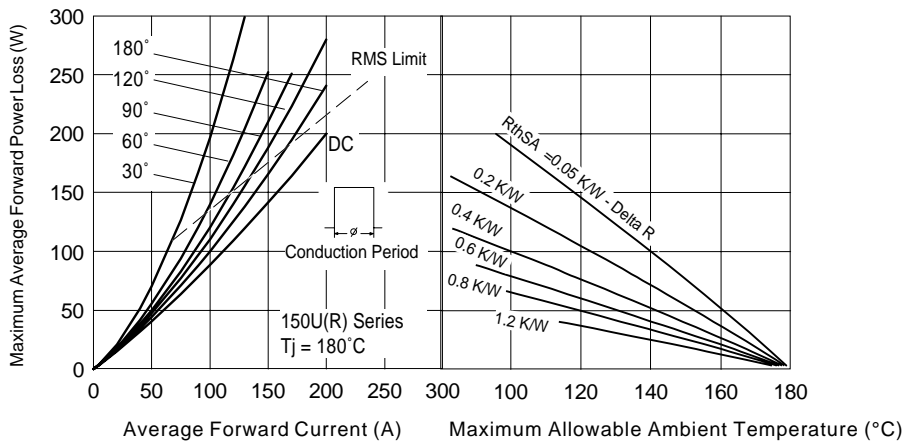
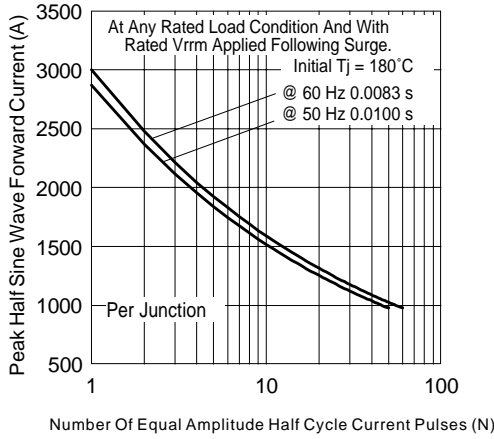
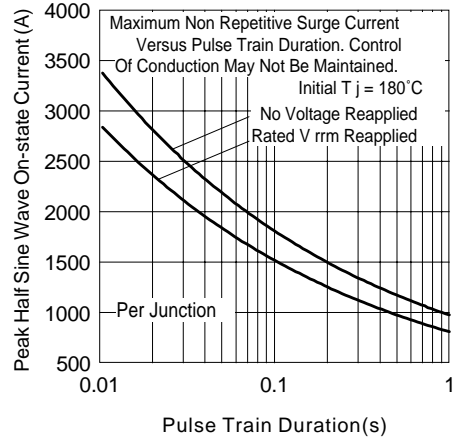

Fig. 4 - Forward Power Loss Characteristics



Number Of Equal Amplitude Half Cycle Current Pulses (N)

Fig. 5 - Maximum Non-Repetitive Surge Current



Pulse Train Duration(s)

Fig. 6 - Maximum Non-Repetitive Surge Current

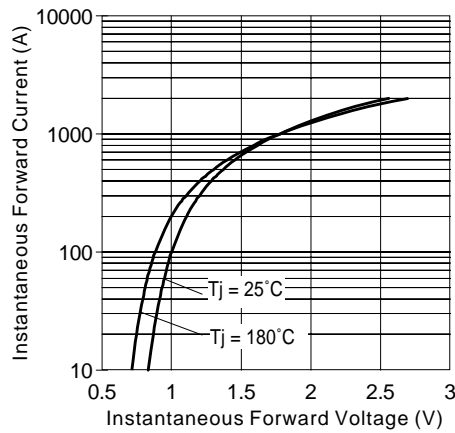

Fig. 7 - Forward Voltage Drop Characteristics

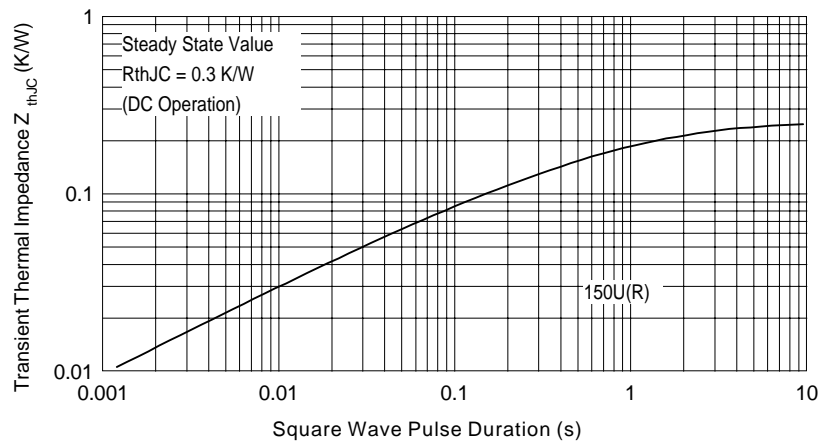

Fig. 8 - Thermal Impedance  $Z_{thJC}$  Characteristic

## 150U(R).. Series

Bulletin I2025 rev. D 03/03

International  
**IOR** Rectifier

---

Data and specifications subject to change without notice.  
This product has been designed and qualified for Industrial Level.  
Qualification Standards can be found on IR's Web site.

International  
**IOR** Rectifier

**IR WORLD HEADQUARTERS:** 233 Kansas St., El Segundo, California 90245, USA Tel: (310) 252-7105  
TAC Fax: (310) 252-7309  
Visit us at [www.irf.com](http://www.irf.com) for sales contact information. 03/03