

V_{DSM}	=	1800 V
I_{TAVM}	=	1660 A
I_{TRMS}	=	2610 A
I_{TSM}	=	21000 A
V_{T0}	=	0.83 V
r_T	=	0.23 m Ω

Phase Control Thyristor

5STP 18F1800

Doc. No. 5SYA1028-04 Jan. 02

- Patented free-floating silicon technology
- Low on-state and switching losses
- Designed for traction, energy and industrial applications
- Optimum power handling capability

Blocking

Maximum rated values ¹⁾

Symbol	Conditions	5STP 18F1800	5STP 18F1600	5STP 18F1200
V_{DRM}, V_{RRM}	f = 50 Hz, $t_p = 10ms$	1800 V	1600 V	1200 V
V_{RSM1}	$t_p = 5ms$, single pulse	2000 V	1800 V	1400 V
dV/dt_{crit}	Exp. to $0.67 \times V_{DRM}$, $T_j = 125^\circ C$	1000 V/ μs		

Characteristic values

Parameter	Symbol	Conditions	min	typ	max	Unit
Forward leakage current	I_{DRM}	V_{DRM} , $T_j = 125^\circ C$			200	mA
Reverse leakage current	I_{RRM}	V_{RRM} , $T_j = 125^\circ C$			200	mA

Mechanical data

Maximum rated values ¹⁾

Parameter	Symbol	Conditions	min	typ	max	Unit
Mounting force	F_M		14	22	24	kN
Acceleration	a	Device unclamped			50	m/s ²
Acceleration	a	Device clamped			100	m/s ²

Characteristic values

Parameter	Symbol	Conditions	min	typ	max	Unit
Weight	m			0.6		kg
Surface creepage distance	D_s		25			mm
Air strike distance	D_a		14			mm

¹⁾ Maximum Ratings are those values beyond which damage to the device may occur

ABB Switzerland Ltd, Semiconductors reserves the right to change specifications without notice.



On-state

Maximum rated values ¹⁾

Parameter	Symbol	Conditions	min	typ	max	Unit
Max. average on-state current	I_{TAVM}	Half sine wave, $T_c = 70^\circ\text{C}$			1660	A
RMS on-state current	I_{TRMS}				2610	A
Max. peak non-repetitive surge current	I_{TSM}	$t_p = 10\text{ ms}$, $T_j = 125^\circ\text{C}$, $V_D = V_R = 0\text{ V}$			21000	A
Limiting load integral	I^2t				2205	kA^2s
Max. peak non-repetitive surge current	I_{TSM}	$t_p = 8.3\text{ ms}$, $T_j = 125^\circ\text{C}$, $V_D = V_R = 0\text{ V}$			22000	A
Limiting load integral	I^2t				2008	kA^2s

Characteristic values

Parameter	Symbol	Conditions	min	typ	max	Unit
On-state voltage	V_T	$I_T = 2000\text{ A}$, $T_j = 125^\circ\text{C}$			1.3	V
Threshold voltage	V_{T0}	$I_T = 1000\text{ A} - 3000\text{ A}$, $T_j = 125^\circ\text{C}$			0.83	V
Slope resistance	r_T	$T_j = 125^\circ\text{C}$			0.23	$\text{m}\Omega$
Holding current	I_H	$T_j = 25^\circ\text{C}$			70	mA
		$T_j = 125^\circ\text{C}$			60	mA
Latching current	I_L	$T_j = 25^\circ\text{C}$			500	mA
		$T_j = 125^\circ\text{C}$			200	mA

Switching

Maximum rated values ¹⁾

Parameter	Symbol	Conditions	min	typ	max	Unit
Critical rate of rise of on-state current	di/dt_{crit}	$T_j = 125^\circ\text{C}$, $I_{TRM} = 2000\text{ A}$, $V_D \leq 0.67 \cdot V_{DRM}$, $I_{FG} = 2\text{ A}$, $t_r = 0.5\text{ }\mu\text{s}$			150	$\text{A}/\mu\text{s}$
Critical rate of rise of on-state current	di/dt_{crit}		Cont. $f = 50\text{ Hz}$			1000
Circuit-commutated turn-off time	t_q	$T_j = 125^\circ\text{C}$, $I_{TRM} = 2000\text{ A}$, $V_R = 200\text{ V}$, $di_T/dt = -20\text{ A}/\mu\text{s}$, $V_D \leq 0.67 \cdot V_{DRM}$, $dv_D/dt = 20\text{ V}/\mu\text{s}$,	400			μs

Characteristic values

Parameter	Symbol	Conditions	min	typ	max	Unit
Recovery charge	Q_{rr}	$T_j = 125^\circ\text{C}$, $I_{TRM} = 2000\text{ A}$, $V_R = 200\text{ V}$, $di_T/dt = -20\text{ A}/\mu\text{s}$	2500		4500	μAs
Delay time	t_d	$V_D = 0.4 \cdot V_{DRM}$, $I_{FG} = 2\text{ A}$, $t_r = 0.5\text{ }\mu\text{s}$			3	μs

Triggering

Maximum rated values ¹⁾

Parameter	Symbol	Conditions	min	typ	max	Unit
Peak forward gate voltage	V _{FGM}				12	V
Peak forward gate current	I _{FGM}				10	A
Peak reverse gate voltage	V _{RGM}				10	V
Gate power loss	P _G	For DC gate current			3	W
Average gate power loss	P _{GAV}		see Fig. 9			

Characteristic values

Parameter	Symbol	Conditions	min	typ	max	Unit
Gate trigger voltage	V _{GT}	T _j = 25°C			2.6	V
Gate trigger current	I _{GT}	T _j = 25°C			400	mA
Gate non-trigger voltage	V _{GD}	V _D = 0.4 x V _{DRM} , T _{vjmax} = 125°C	0.3			V
Gate non-trigger current	I _{GD}	V _D = 0.4 x V _{DRM} , T _{vjmax} = 125°C	10			mA

Thermal

Maximum rated values ¹⁾

Parameter	Symbol	Conditions	min	typ	max	Unit
Operating junction temperature range	T _j				125	°C
Storage temperature range	T _{stg}		-40		140	°C

Characteristic values

Parameter	Symbol	Conditions	min	typ	max	Unit
Thermal resistance junction to case	R _{th(j-c)}	Double side cooled			17	K/kW
	R _{th(j-c)A}	Anode side cooled			33	K/kW
	R _{th(j-c)C}	Cathode side cooled			35	K/kW
Thermal resistance case to heatsink	R _{th(c-h)}	Double side cooled			4	K/kW
	R _{th(c-h)}	Single side cooled			8	K/kW

Analytical function for transient thermal impedance:

$$Z_{thJC}(t) = \sum_{i=1}^n R_i(1 - e^{-t/\tau_i})$$

i	1	2	3	4
R _i (K/kW)	10.35	3.76	2.29	0.67
τ _i (s)	0.3723	0.0525	0.0057	0.0023

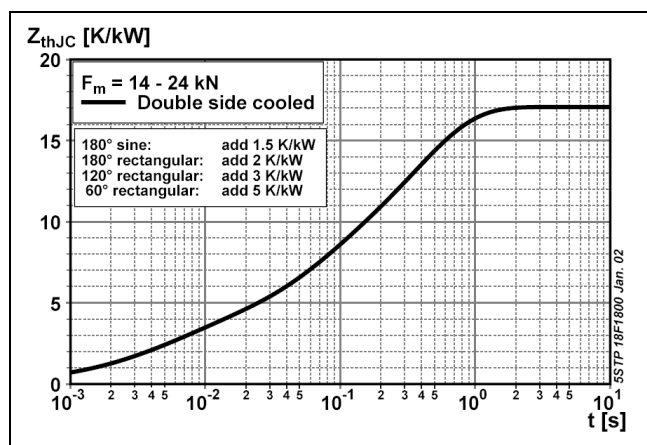

Fig. 1 Transient thermal impedance junction-to case.

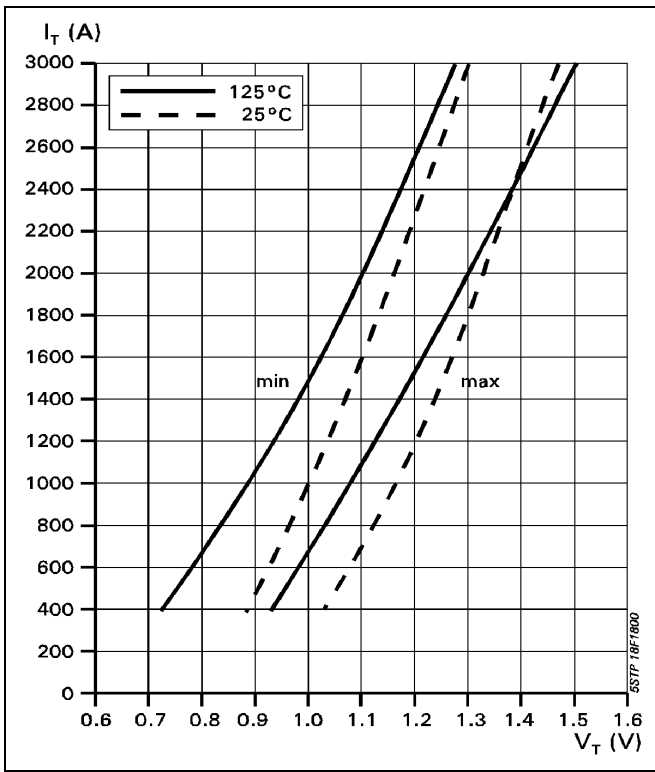

Fig. 2 On-state characteristics.

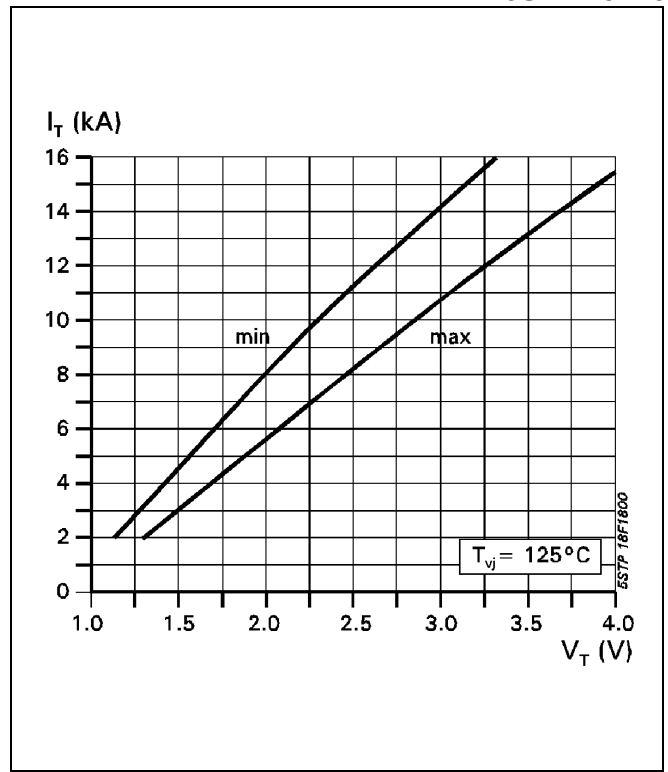

Fig. 3 On-state characteristics.
 $T_j=125^\circ\text{C}$, 10ms half sine

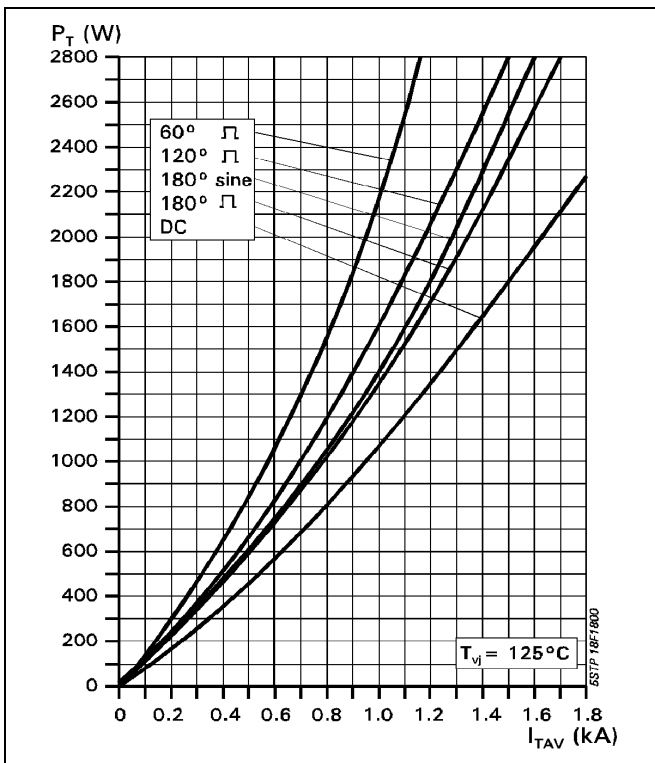

Fig. 4 On-state power dissipation vs. mean on-state current. Turn - on losses excluded.

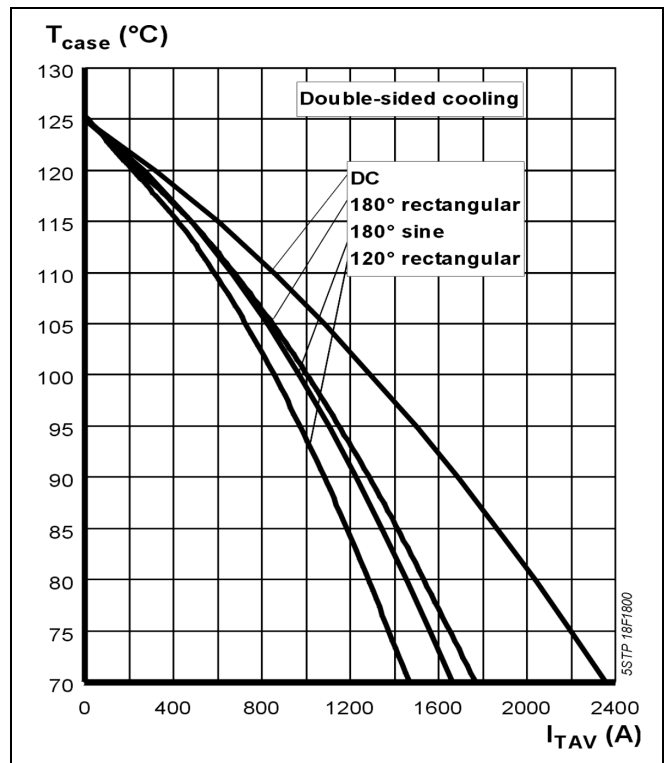

Fig. 5 Max. permissible case temperature vs. mean on-state current.

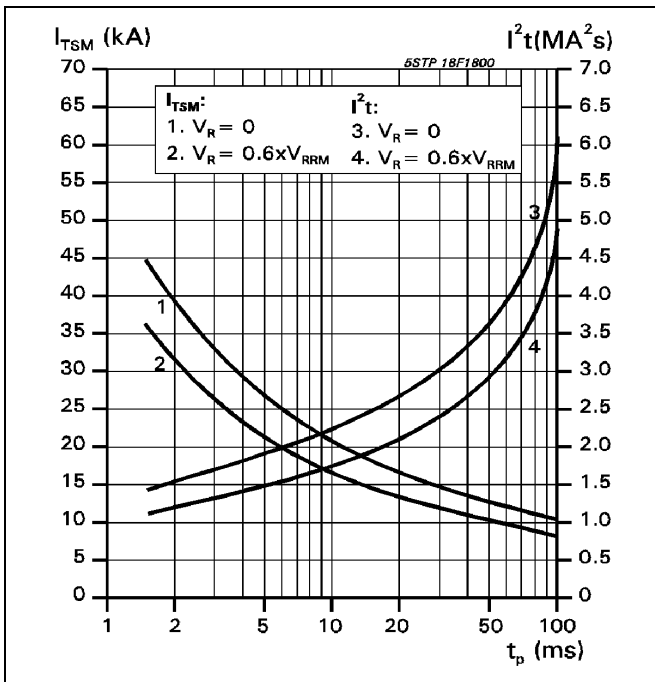

Fig. 6 Surge on-state current vs. pulse length. Half-sine wave.

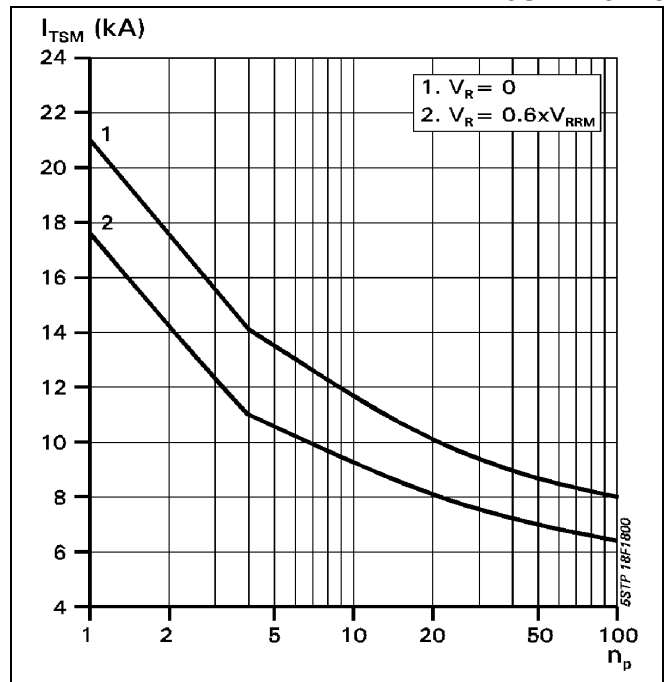

Fig. 7 Surge on-state current vs. number of pulses. Half-sine wave, 10 ms, 50Hz.

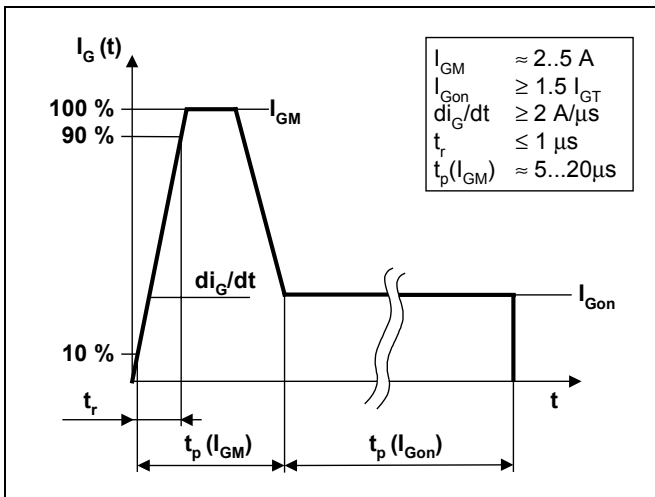

Fig. 8 Recommended gate current waveform.

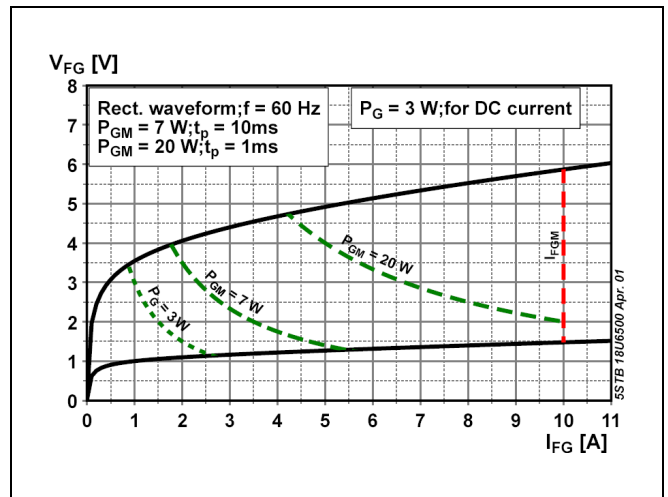

Fig. 9 Max. peak gate power loss.

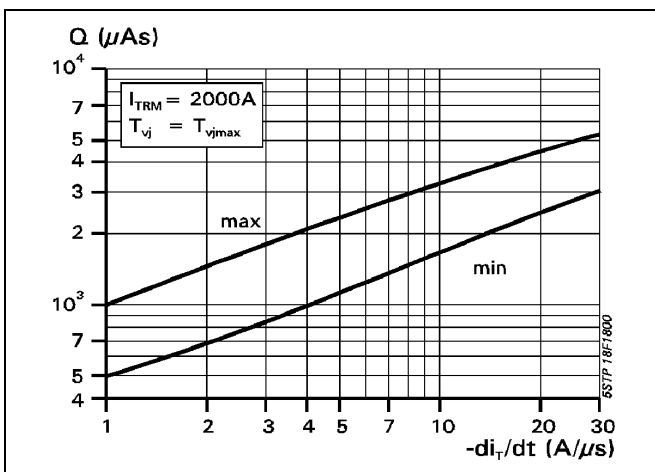

Fig. 10 Recovery charge vs. decay rate of on-state current.

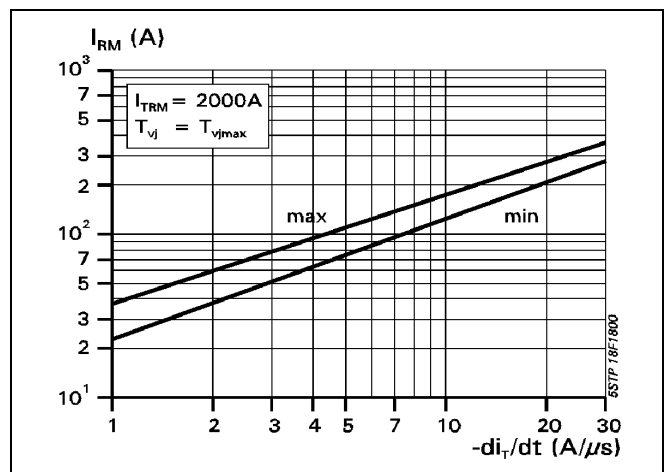

Fig. 11 Peak reverse recovery current vs. decay rate of on-state current.

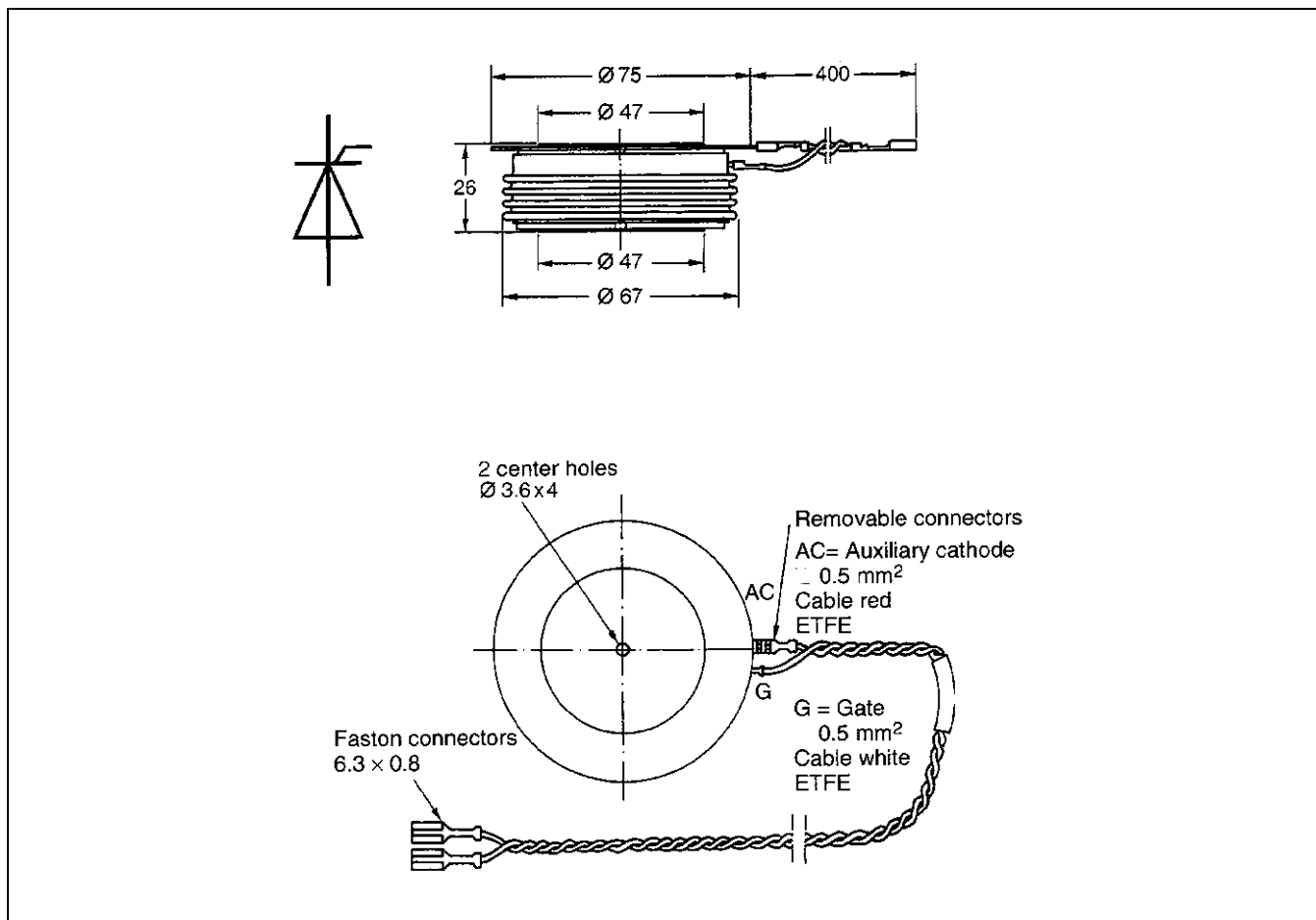

Fig. 12 Device Outline Drawing.

ABB Switzerland Ltd, Semiconductors reserves the right to change specifications without notice.



ABB Switzerland Ltd
Semiconductors
 Fabrikstrasse 3
 CH-5600 Lenzburg, Switzerland

Doc. No. 5SYA1028-04 Jan. 02

Telephone +41 (0)58 586 1419
 Fax +41 (0)58 586 1306
 Email abbsem@ch.abb.com
 Internet www.abbsem.com