

Utilizing the latest Field Stop and Trench Gate technologies, these IGBT's have ultra low  $V_{CE(ON)}$  and are ideal for low frequency applications that require absolute minimum conduction loss. Easy paralleling is a result of very tight parameter distribution and a slightly positive  $V_{CE(ON)}$  temperature coefficient. A built-in gate resistor ensures extremely reliable operation, even in the event of a short circuit fault. Low gate charge simplifies gate drive design and minimizes losses

- 600V Field Stop
- Trench Gate: Low  $V_{CE(on)}$
- Easy Paralleling
- 5 $\mu$ s Short Circuit Capability
- Intergrated Gate Resistor: Low EMI, High Reliability
- 175°C Rated

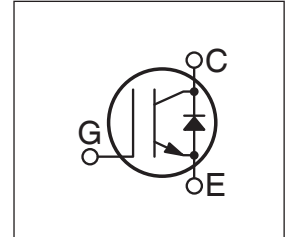

**Applications:** welding, inductive heating, solar inverters, motor drives, UPS, pass transistor

### MAXIMUM RATINGS

All Ratings:  $T_C = 25^\circ\text{C}$  unless otherwise specified.

Symbol	Parameter	APT200GN60JDQ4	UNIT
$V_{CES}$	Collector-Emitter Voltage	600	Volts
$V_{GE}$	Gate-Emitter Voltage	$\pm 20$	
$I_{C1}$	Continuous Collector Current @ $T_C = 25^\circ\text{C}$	283	Amps
$I_{C2}$	Continuous Collector Current @ $T_C = 110^\circ\text{C}$	158	
$I_{CM}$	Pulsed Collector Current <sup>①</sup>	600	
SSOA	Switching Safe Operating Area @ $T_J = 175^\circ\text{C}$	600A @ 600V	
$P_D$	Total Power Dissipation	682	Watts
$T_J, T_{STG}$	Operating and Storage Junction Temperature Range	-55 to 175	$^\circ\text{C}$

### STATIC ELECTRICAL CHARACTERISTICS

Symbol	Characteristic / Test Conditions	MIN	TYP	MAX	UNIT
$V_{(BR)CES}$	Collector-Emitter Breakdown Voltage ( $V_{GE} = 0\text{V}, I_C = 4\text{mA}$ )	600			Volts
$V_{GE(TH)}$	Gate Threshold Voltage ( $V_{CE} = V_{GE}, I_C = 3.2\text{mA}, T_J = 25^\circ\text{C}$ )	5	5.8	6.5	
$V_{CE(ON)}$	Collector-Emitter On Voltage ( $V_{GE} = 15\text{V}, I_C = 200\text{A}, T_J = 25^\circ\text{C}$ )	1.05	1.45	1.85	
	Collector-Emitter On Voltage ( $V_{GE} = 15\text{V}, I_C = 200\text{A}, T_J = 125^\circ\text{C}$ )		1.65		
	Collector-Emitter On Voltage ( $V_{GE} = 15\text{V}, I_C = 100\text{A}, T_J = 25^\circ\text{C}$ )		1.15		
	Collector-Emitter On Voltage ( $V_{GE} = 15\text{V}, I_C = 100\text{A}, T_J = 125^\circ\text{C}$ )		1.19		
$I_{CES}$	Collector Cut-off Current ( $V_{CE} = 600\text{V}, V_{GE} = 0\text{V}, T_J = 25^\circ\text{C}$ ) <sup>②</sup>			50	$\mu\text{A}$
	Collector Cut-off Current ( $V_{CE} = 600\text{V}, V_{GE} = 0\text{V}, T_J = 125^\circ\text{C}$ ) <sup>②</sup>			TBD	
$I_{GES}$	Gate-Emitter Leakage Current ( $V_{GE} = \pm 20\text{V}$ )			600	nA
$R_{GINT}$	Intergrated Gate Resistor		2		$\Omega$



**CAUTION:** These Devices are Sensitive to Electrostatic Discharge. Proper Handling Procedures Should Be Followed.

APT Website - <http://www.advancedpower.com>

Symbol	Characteristic	Test Conditions	MIN	TYP	MAX	UNIT	
C <sub>ies</sub>	Input Capacitance	<b>Capacitance</b> V <sub>GE</sub> = 0V, V <sub>CE</sub> = 25V f = 1 MHz		14100		pF	
C <sub>oes</sub>	Output Capacitance			4610			
C <sub>res</sub>	Reverse Transfer Capacitance			4000			
V <sub>GEP</sub>	Gate-to-Emitter Plateau Voltage	Gate Charge		8.2		V	
Q <sub>g</sub>	Total Gate Charge <sup>③</sup>	V <sub>GE</sub> = 15V		1180		nC	
Q <sub>ge</sub>	Gate-Emitter Charge	V <sub>CE</sub> = 300V		85			
Q <sub>gc</sub>	Gate-Collector ("Miller") Charge	I <sub>C</sub> = 100A		660			
SSOA	Switching Safe Operating Area	T <sub>J</sub> = 175°C, R <sub>G</sub> = 1.0Ω <sup>⑦</sup> , V <sub>GE</sub> = 15V, L = 100μH, V <sub>CE</sub> = 600V	600			A	
SCSOA	Short Circuit Safe Operating Area	V <sub>CC</sub> = 360V, V <sub>GE</sub> = 15V, T <sub>J</sub> = 150°C, R <sub>G</sub> = 1.0Ω <sup>⑦</sup>	5			μs	
t <sub>d(on)</sub>	Turn-on Delay Time	<b>Inductive Switching (25°C)</b>  V <sub>CC</sub> = 400V V <sub>GE</sub> = 15V I <sub>C</sub> = 200A R <sub>G</sub> = 1.0Ω <sup>⑦</sup> T <sub>J</sub> = +25°C		50		ns	
t <sub>r</sub>	Current Rise Time			80			
t <sub>d(off)</sub>	Turn-off Delay Time			560			
t <sub>f</sub>	Current Fall Time			100			
E <sub>on1</sub>	Turn-on Switching Energy <sup>④</sup>				13		mJ
E <sub>on2</sub>	Turn-on Switching Energy (Diode) <sup>⑤</sup>				15		
E <sub>off</sub>	Turn-off Switching Energy <sup>⑥</sup>				11		
t <sub>d(on)</sub>	Turn-on Delay Time	<b>Inductive Switching (125°C)</b>  V <sub>CC</sub> = 400V V <sub>GE</sub> = 15V I <sub>C</sub> = 200A R <sub>G</sub> = 1.0Ω <sup>⑦</sup> T <sub>J</sub> = +125°C		50		ns	
t <sub>r</sub>	Current Rise Time			80			
t <sub>d(off)</sub>	Turn-off Delay Time			620			
t <sub>f</sub>	Current Fall Time			70			
E <sub>on1</sub>	Turn-on Switching Energy <sup>④</sup>				14		mJ
E <sub>on2</sub>	Turn-on Switching Energy (Diode) <sup>⑤</sup>				16		
E <sub>off</sub>	Turn-off Switching Energy <sup>⑥</sup>				10		

**THERMAL AND MECHANICAL CHARACTERISTICS**

Symbol	Characteristic	MIN	TYP	MAX	UNIT
R <sub>θJC</sub>	Junction to Case ( <b>IGBT</b> )			.22	°C/W
R <sub>θJC</sub>	Junction to Case ( <b>DIODE</b> )			.33	
V <sub>Isolation</sub>	RMS Voltage (50-60Hz Sinusoidal Waveform from Terminals to Mounting Base for 1 Min.)	2500			Volts
W <sub>T</sub>	Package Weight		1.03		oz
			29.2		gm
Torque	Maximum Terminal & Mounting Torque			10	lb•in
				1.1	N•m

- ① Repetitive Rating: Pulse width limited by maximum junction temperature.
- ② For Combi devices, I<sub>ces</sub> includes both IGBT and FRED leakages
- ③ See MIL-STD-750 Method 3471.
- ④ E<sub>on1</sub> is the clamped inductive turn-on energy of the IGBT only, without the effect of a commutating diode reverse recovery current adding to the IGBT turn-on loss. Tested in inductive switching test circuit shown in figure 21, but with a Silicon Carbide diode.
- ⑤ E<sub>on2</sub> is the clamped inductive turn-on energy that includes a commutating diode reverse recovery current in the IGBT turn-on switching loss. (See Figures 21, 22.)
- ⑥ E<sub>off</sub> is the clamped inductive turn-off energy measured in accordance with JEDEC standard JESD24-1. (See Figures 21, 23.)
- ⑦ R<sub>G</sub> is external gate resistance, not including R<sub>G(int)</sub> nor gate driver impedance. (MIC4452)

**APT Reserves the right to change, without notice, the specifications and information contained herein.**

# TYPICAL PERFORMANCE CURVES

APT200GN60JDQ4

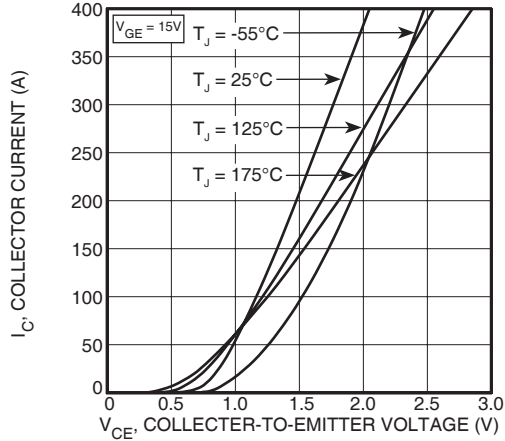

FIGURE 1, Output Characteristics( $T_J = 25^\circ\text{C}$ )

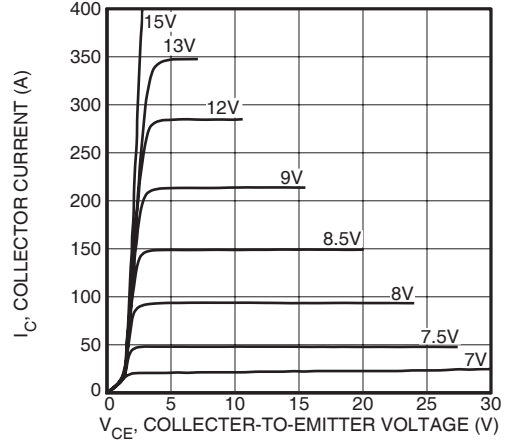

FIGURE 2, Output Characteristics ( $T_J = 125^\circ\text{C}$ )

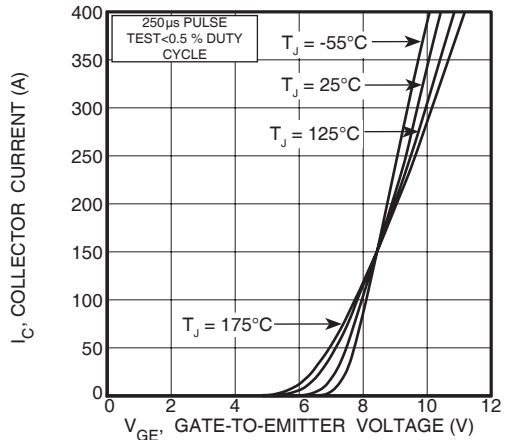

FIGURE 3, Transfer Characteristics

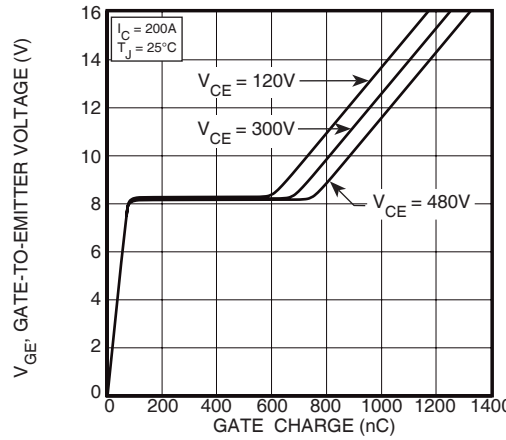

FIGURE 4, Gate Charge

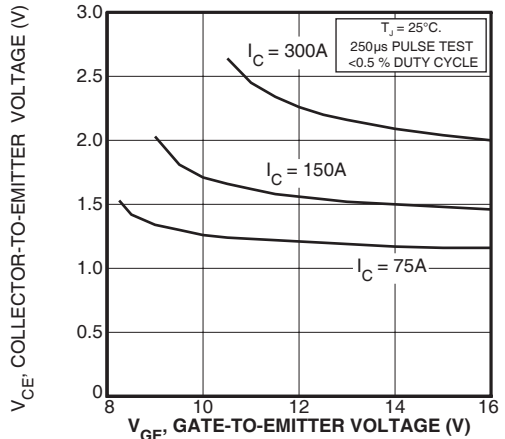

FIGURE 5, On State Voltage vs Gate-to-Emitter Voltage

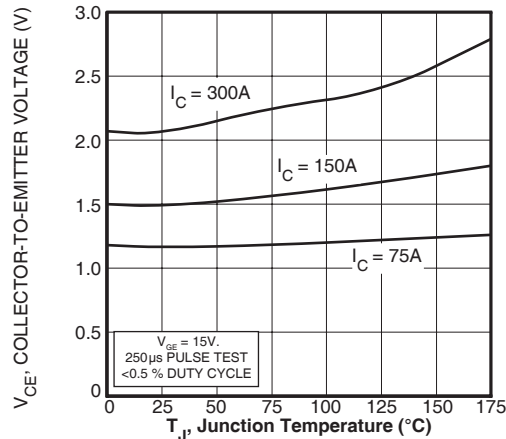

FIGURE 6, On State Voltage vs Junction Temperature

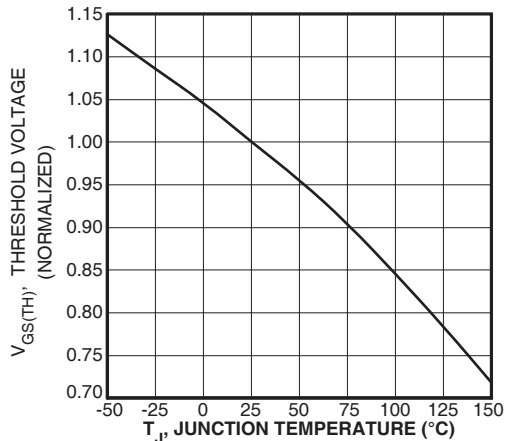

FIGURE 7, Threshold Voltage vs. Junction Temperature

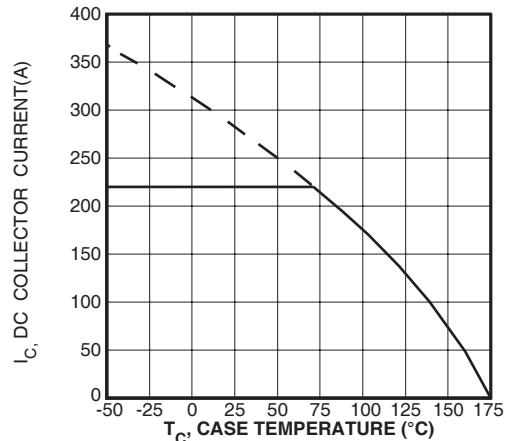

FIGURE 8, DC Collector Current vs Case Temperature

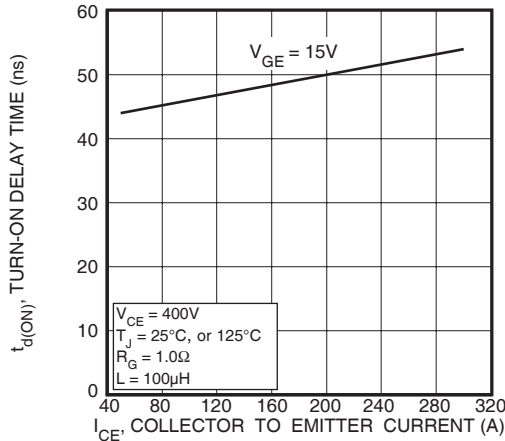

FIGURE 9, Turn-On Delay Time vs Collector Current

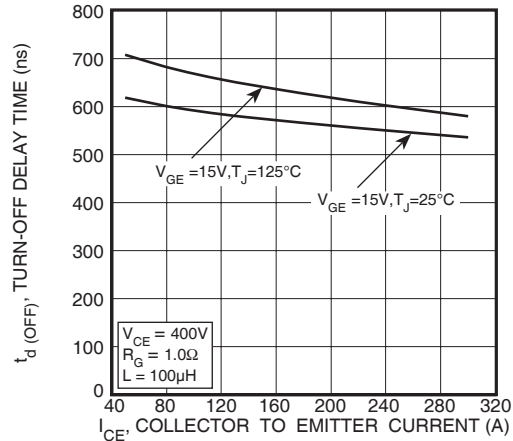

FIGURE 10, Turn-Off Delay Time vs Collector Current

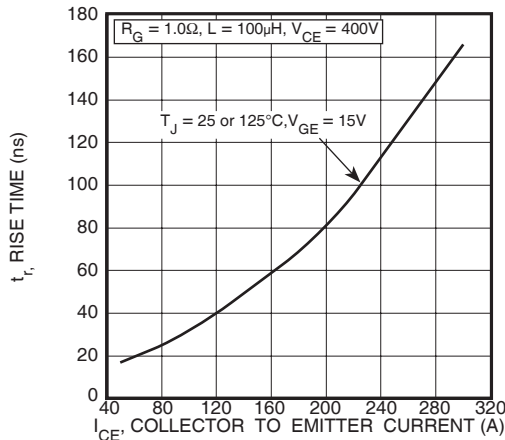

FIGURE 11, Current Rise Time vs Collector Current

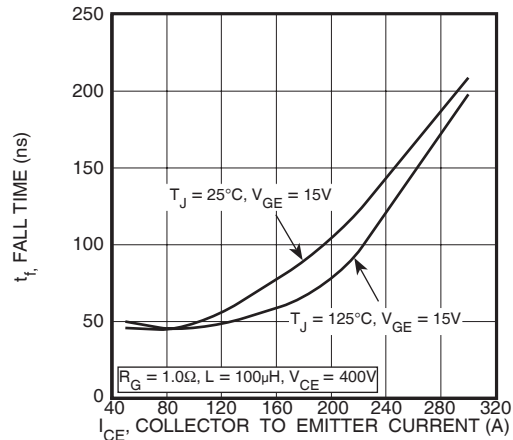

FIGURE 12, Current Fall Time vs Collector Current

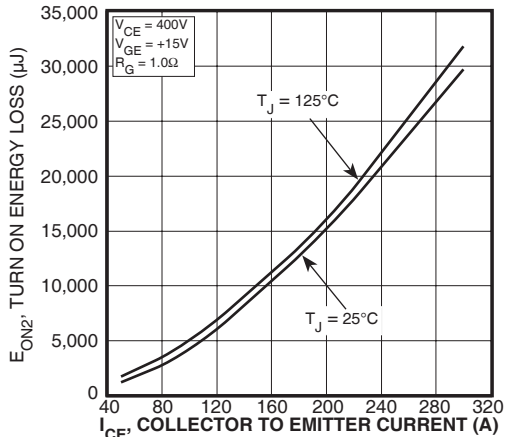

FIGURE 13, Turn-On Energy Loss vs Collector Current

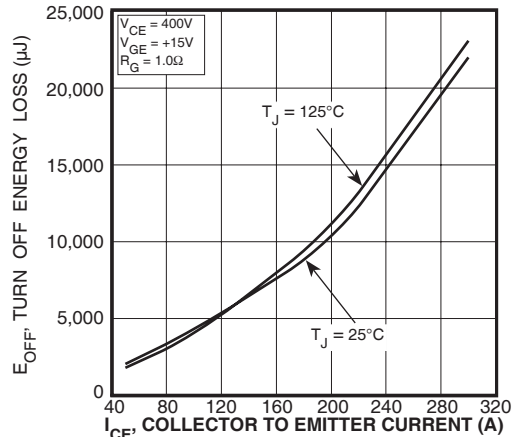

FIGURE 14, Turn Off Energy Loss vs Collector Current

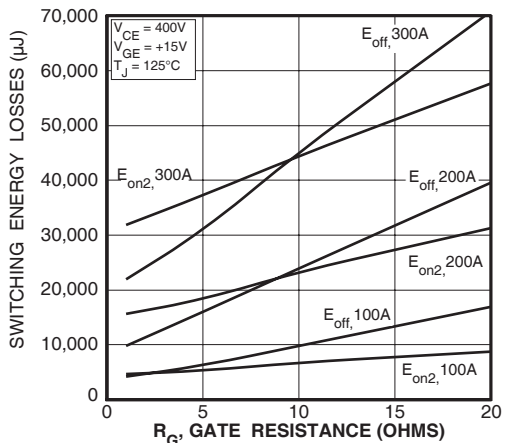

FIGURE 15, Switching Energy Losses vs. Gate Resistance

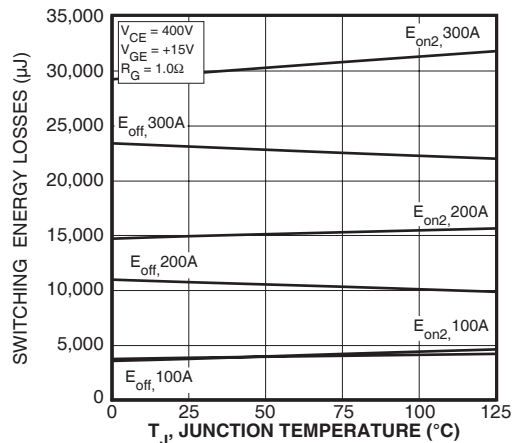

FIGURE 16, Switching Energy Losses vs Junction Temperature

### TYPICAL PERFORMANCE CURVES

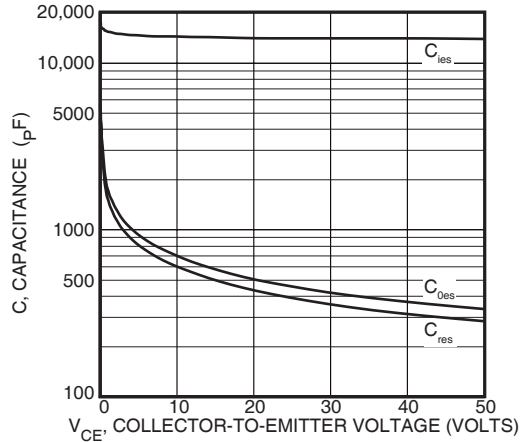

Figure 17, Capacitance vs Collector-To-Emitter Voltage

### APT200GN60JDQ4

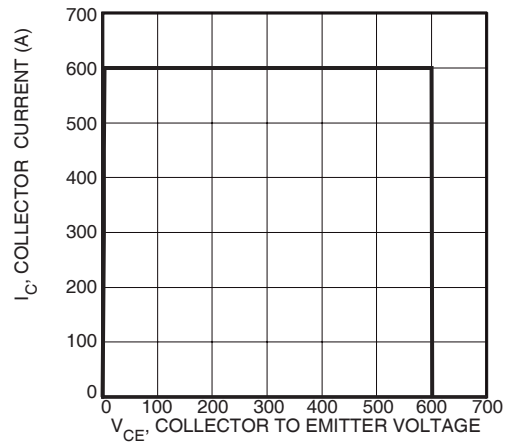

Figure 18, Minimum Switching Safe Operating Area

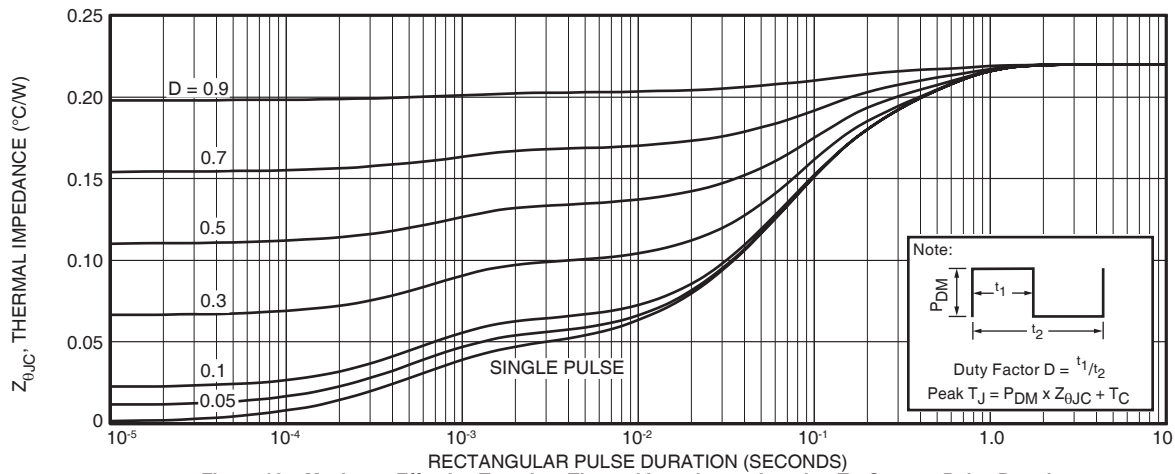

Figure 19a, Maximum Effective Transient Thermal Impedance, Junction-To-Case vs Pulse Duration

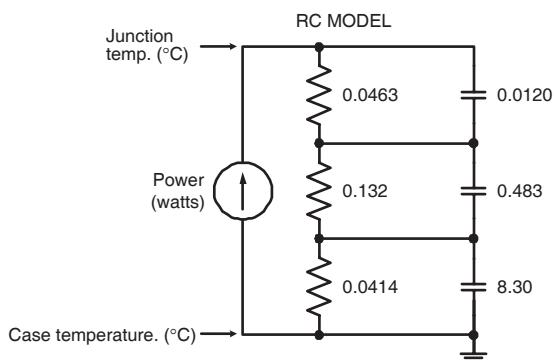

FIGURE 19b, TRANSIENT THERMAL IMPEDANCE MODEL

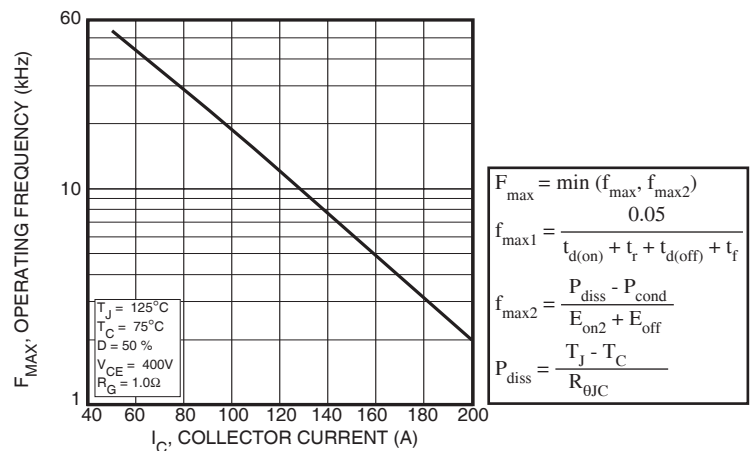

Figure 20, Operating Frequency vs Collector Current

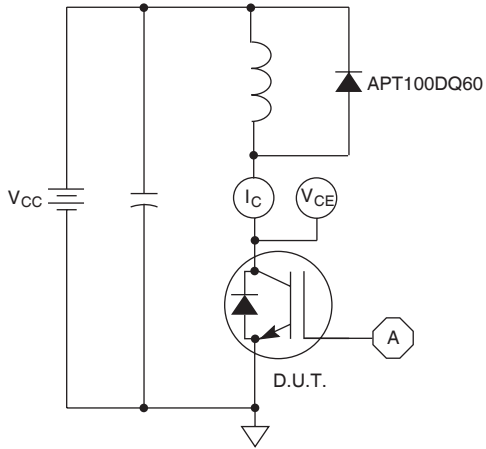

Figure 21, Inductive Switching Test Circuit

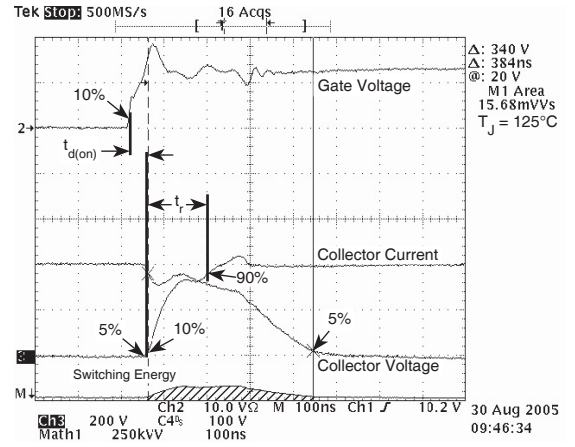

Figure 22, Turn-on Switching Waveforms and Definitions

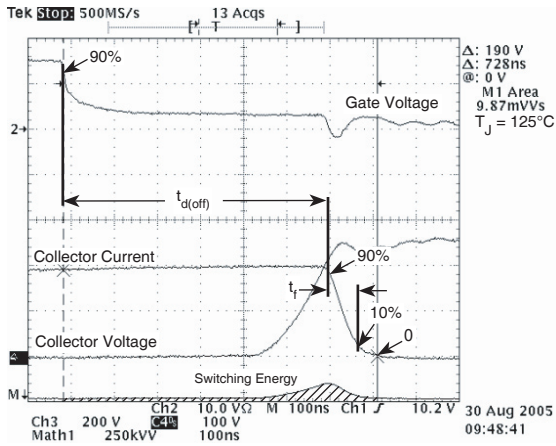

Figure 23, Turn-off Switching Waveforms and Definitions

# ULTRAFAST SOFT RECOVERY ANTI-PARALLEL DIODE

**MAXIMUM RATINGS**

All Ratings:  $T_C = 25^\circ\text{C}$  unless otherwise specified.

Symbol	Characteristic / Test Conditions	APT200GN60LDQ4		UNIT
$I_F(\text{AV})$	Maximum Average Forward Current ( $T_C = 108^\circ\text{C}$ , Duty Cycle = 0.5)		100	Amps
$I_F(\text{RMS})$	RMS Forward Current (Square wave, 50% duty)		156	
$I_{\text{FSM}}$	Non-Repetitive Forward Surge Current ( $T_J = 45^\circ\text{C}$ , 8.3ms)		1000	

**STATIC ELECTRICAL CHARACTERISTICS**

Symbol	Characteristic / Test Conditions	MIN	TYP	MAX	UNIT
$V_F$	Forward Voltage		$I_F = 200\text{A}$		Volts
			$I_F = 400\text{A}$		
			$I_F = 200\text{A}, T_J = 125^\circ\text{C}$		

**DYNAMIC CHARACTERISTICS**

Symbol	Characteristic	Test Conditions	MIN	TYP	MAX	UNIT
$t_{\text{rr}}$	Reverse Recovery Time	$I_F = 1\text{A}, di_F/dt = -100\text{A}/\mu\text{s}, V_R = 30\text{V}, T_J = 25^\circ\text{C}$	-	34		ns
$t_{\text{rr}}$	Reverse Recovery Time	$I_F = 100\text{A}, di_F/dt = -200\text{A}/\mu\text{s}, V_R = 400\text{V}, T_C = 25^\circ\text{C}$	-	160		
$Q_{\text{rr}}$	Reverse Recovery Charge		-	290		nC
$I_{\text{RRM}}$	Maximum Reverse Recovery Current		-	5	-	Amps
$t_{\text{rr}}$	Reverse Recovery Time	$I_F = 100\text{A}, di_F/dt = -200\text{A}/\mu\text{s}, V_R = 400\text{V}, T_C = 125^\circ\text{C}$	-	220		ns
$Q_{\text{rr}}$	Reverse Recovery Charge		-	1530		nC
$I_{\text{RRM}}$	Maximum Reverse Recovery Current		-	13	-	Amps
$t_{\text{rr}}$	Reverse Recovery Time	$I_F = 100\text{A}, di_F/dt = -1000\text{A}/\mu\text{s}, V_R = 400\text{V}, T_C = 125^\circ\text{C}$	-	100		ns
$Q_{\text{rr}}$	Reverse Recovery Charge		-	2890		nC
$I_{\text{RRM}}$	Maximum Reverse Recovery Current		-	44		Amps

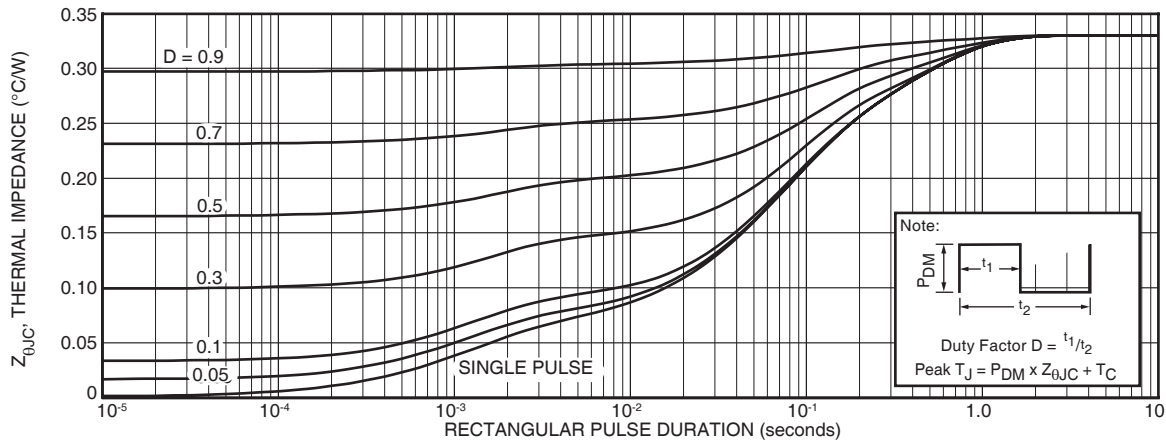

FIGURE 24a. MAXIMUM EFFECTIVE TRANSIENT THERMAL IMPEDANCE, JUNCTION-TO-CASE vs. PULSE DURATION RC MODEL

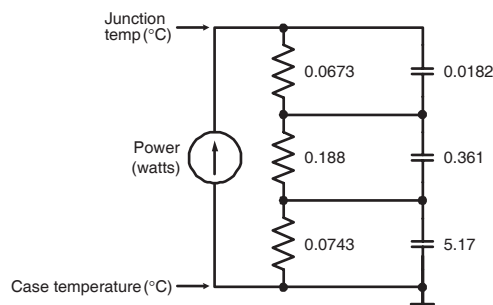

FIGURE 24b, TRANSIENT THERMAL IMPEDANCE MODEL

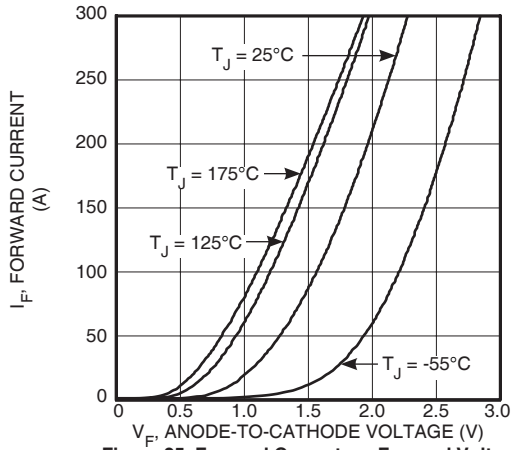

Figure 25. Forward Current vs. Forward Voltage

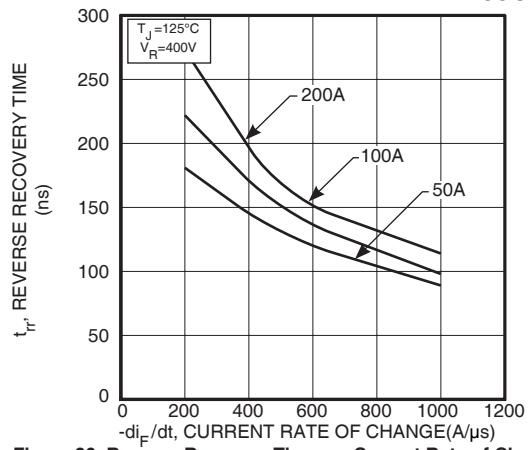

Figure 26. Reverse Recovery Time vs. Current Rate of Change

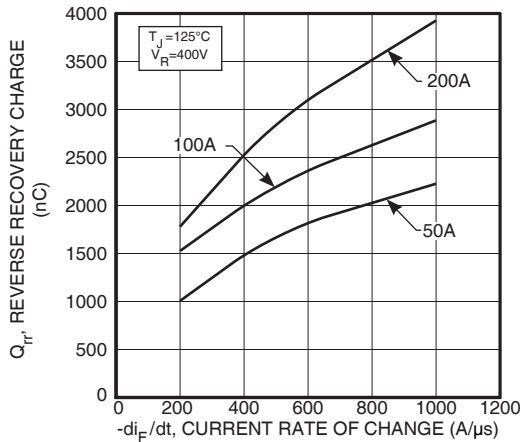

Figure 27. Reverse Recovery Charge vs. Current Rate of Change

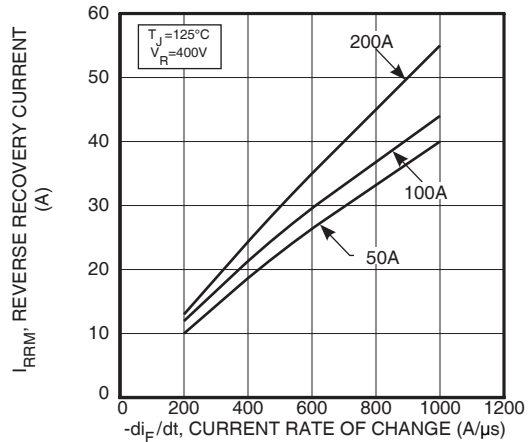

Figure 28. Reverse Recovery Current vs. Current Rate of Change

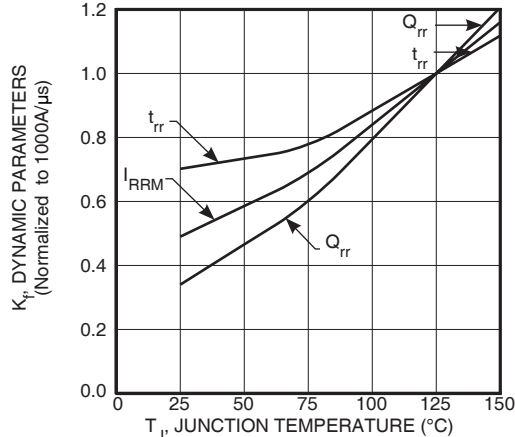

Figure 29. Dynamic Parameters vs. Junction Temperature

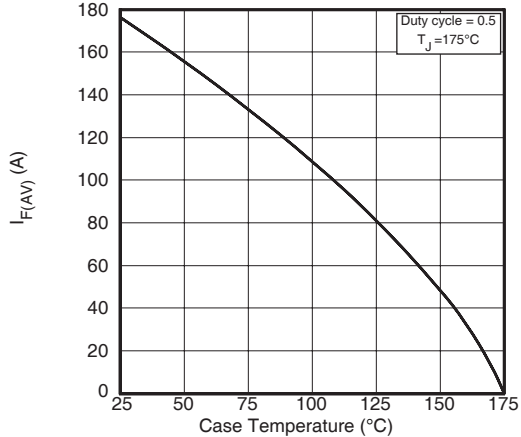

Figure 30. Maximum Average Forward Current vs. Case Temperature

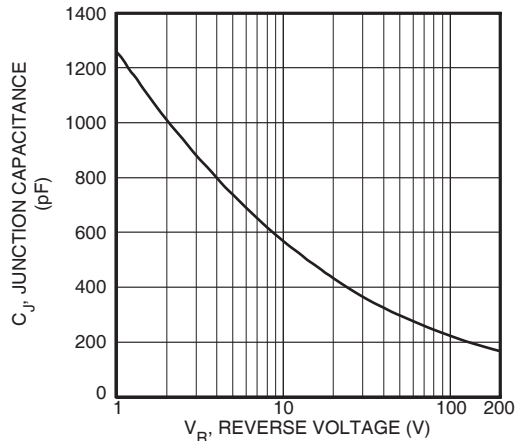

Figure 31. Junction Capacitance vs. Reverse Voltage



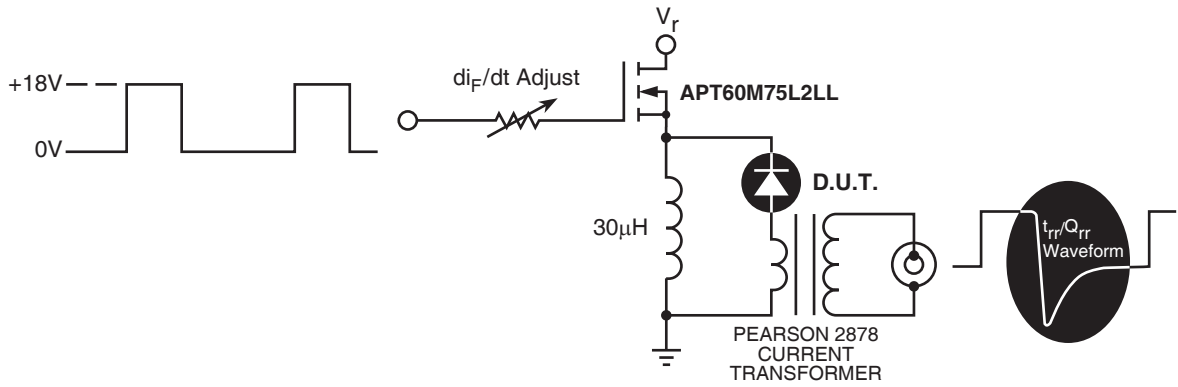

Figure 32. Diode Test Circuit

- 1  $I_F$  - Forward Conduction Current
- 2  $di_F/dt$  - Rate of Diode Current Change Through Zero Crossing.
- 3  $I_{RRM}$  - Maximum Reverse Recovery Current.
- 4  $t_{rr}$  - Reverse Recovery Time, measured from zero crossing where diode current goes from positive to negative, to the point at which the straight line through  $I_{RRM}$  and  $0.25 \cdot I_{RRM}$  passes through zero.
- 5  $Q_{rr}$  - Area Under the Curve Defined by  $I_{RRM}$  and  $t_{rr}$ .



Figure 33. Diode Reverse Recovery Waveform and Definitions

SOT-227 (ISOTOP®) Package Outline

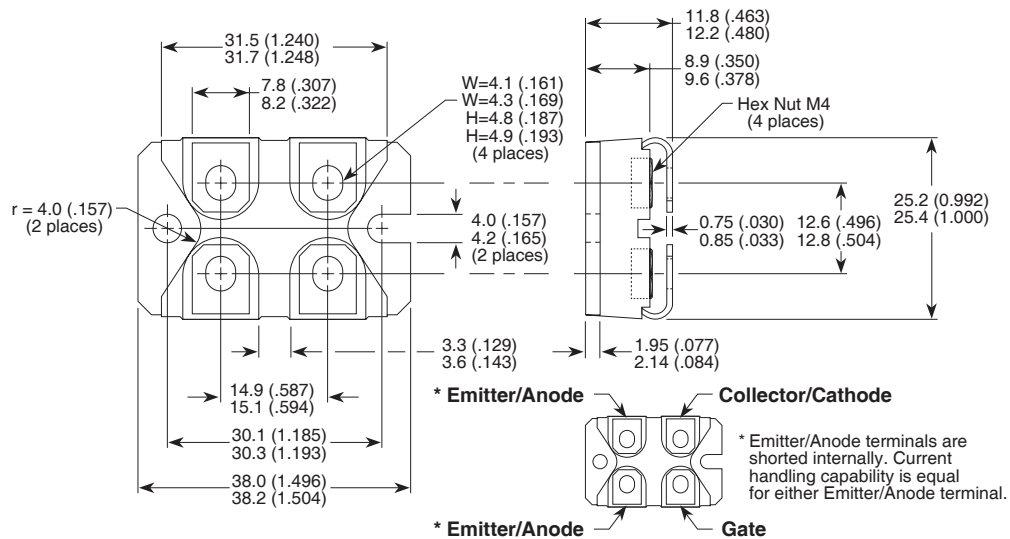

Dimensions in Millimeters and (Inches)