

ANSALDO**Ansaldo Trasporti s.p.a.**
Unita' SemiconduttoriVia N. Lorenzi 8 - I 16152 GENOVA - ITALY
Tel. int. +39/(0)10 6556549 - (0)10 6556488
Fax Int. +39/(0)10 6442510
Tx 270318 ANSUSE I -**FAST SWITCHING THYRISTOR****ATF1047**

Repetitive voltage up to	1400 V
Mean on-state current	1305 A
Surge current	16 kA
Turn-off time	30 µs

FINAL SPECIFICATION

mag 97 - ISSUE : 05

Symbol	Characteristic	Conditions	T _j [°C]	Value	Unit			
BLOCKING								
V _{RRM}	Repetitive peak reverse voltage		125	1400	V			
V _{RSM}	Non-repetitive peak reverse voltage		125	1500	V			
V _{DRM}	Repetitive peak off-state voltage		125	1400	V			
I _{RRM}	Repetitive peak reverse current	V=VRRM	125	100	mA			
I _{DRM}	Repetitive peak off-state current	V=VDRM	125	100	mA			
CONDUCTING								
I _{T(AV)}	Mean on-state current	180° sin, 50 Hz, Th=55°C, double side cooled		1305	A			
I _{T(AV)}	Mean on-state current	180° sin, 1 kHz, Th=55°C, double side cooled		1230	A			
I _{TSM}	Surge on-state current, non repetitive	sine wave, 10 ms	125	16	kA			
I ² t	I ² t	without reverse voltage		1280 x1E3	A ² s			
V _T	On-state voltage	On-state current = 2000 A	25	2	V			
V _{T(TO)}	Threshold voltage		125	1.32	V			
r _T	On-state slope resistance		125	0.230	mohm			
SWITCHING								
di/dt	Critical rate of rise of on-state current, min	From 75% VDRM up to 2000 A, gate 20V 10 ohm	125	500	A/µs			
dv/dt	Critical rate of rise of off-state voltage, min	Linear ramp up to 70% of VDRM	125	600	V/µs			
t _d	Gate controlled delay time, typical	VD=100V, gate source 20V, 10 ohm, tr=1 µs	25	0.6	µs			
t _q	Circuit commutated turn-off time	di/dt = 20 A/µs, I = 800 A dV/dt = 200 V/µs, up to 75% VDRM	125	30	µs			
Q _{rr}	Reverse recovery charge	di/dt = 60 A/µs, I = 1000 A	125	650	µC			
I _{rr}	Peak reverse recovery current	VR = 50 V		230	A			
I _H	Holding current, typical	VD=5V, gate open circuit	25	80	mA			
I _L	Latching current, typical	VD=5V, tp=30µs	25	230	mA			
GATE								
V _{GT}	Gate trigger voltage	VD=5V	25	3.5	V			
I _{GT}	Gate trigger current	VD=5V	25	350	mA			
V _{GD}	Non-trigger gate voltage, min.	VD=VDRM	125	0.25	V			
V _{FGM}	Peak gate voltage (forward)		25	30	V			
I _{FGM}	Peak gate current		25	10	A			
V _{RGM}	Peak gate voltage (reverse)		25	5	V			
P _{GM}	Peak gate power dissipation	Pulse width 100 µs	25	150	W			
P _{G(AV)}	Average gate power dissipation		25	3	W			
MOUNTING								
R _{th(j-h)}	Thermal impedance, DC	Junction to heatsink, double side cooled		26	°C/kW			
T _j	Operating junction temperature			-30 / 125	°C			
F	Mounting force			14.0 / 17.0	kN			
	Mass			500	g			
ORDERING INFORMATION : ATF1047 S 14 M _____ tq code								
standard specification _____ VDRM&VRRM/100								
			tq code	D 10 µs	C 12 µs	B 15 µs	A 20 µs	L 25 µs
				M 30 µs	N 35 µs	P 40 µs	R 45 µs	S 50 µs
				T 60 µs	U 70 µs	W 80 µs	X 100µs	Y 150µs

SWITCHING CHARACTERISTICS

REVERSE RECOVERY CHARGE
T_j = 125 °C

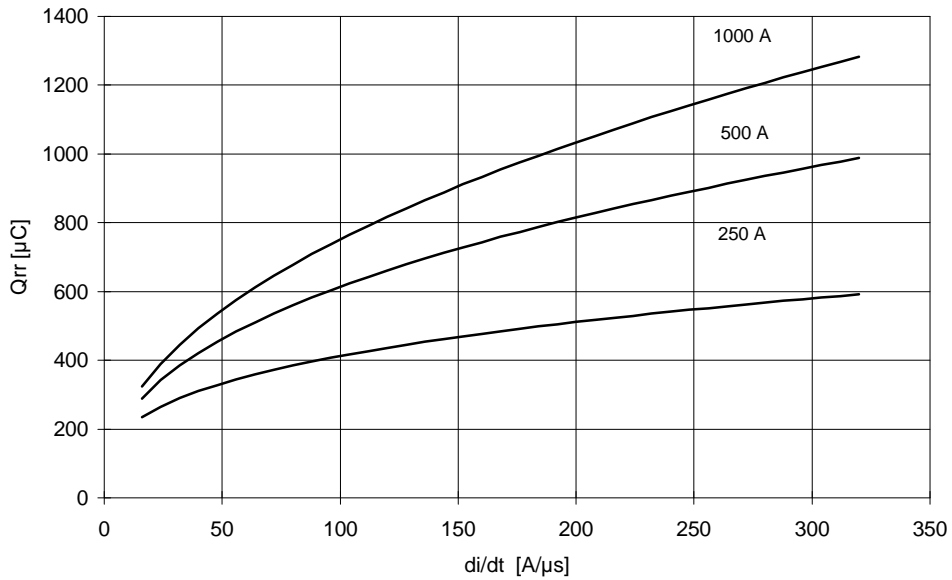

REVERSE RECOVERY CURRENT
T_j = 125 °C

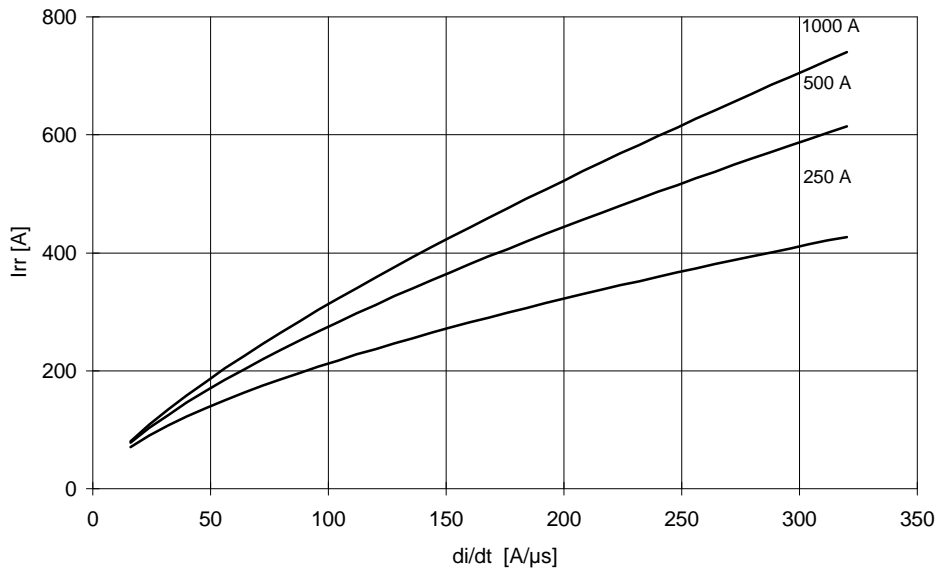

$t_a = I_{rr} / (di/dt) \quad t_b = t_{rr} - t_a$

Softness (s factor) $s = t_b / t_a$

Energy dissipation during recovery $E_r = V_r \cdot (Q_{rr} - I_{rr} \cdot t_a / 2)$

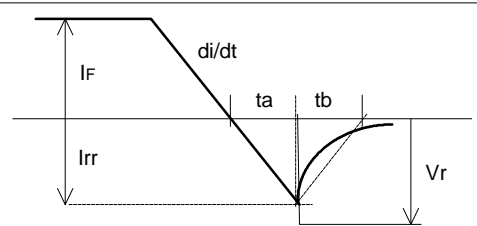

ATF1047 FAST SWITCHING THYRISTOR

ANSALDO

FINAL SPECIFICATION mag 97 - ISSUE : 05

ON-STATE CHARACTERISTIC
T_j = 125 °C

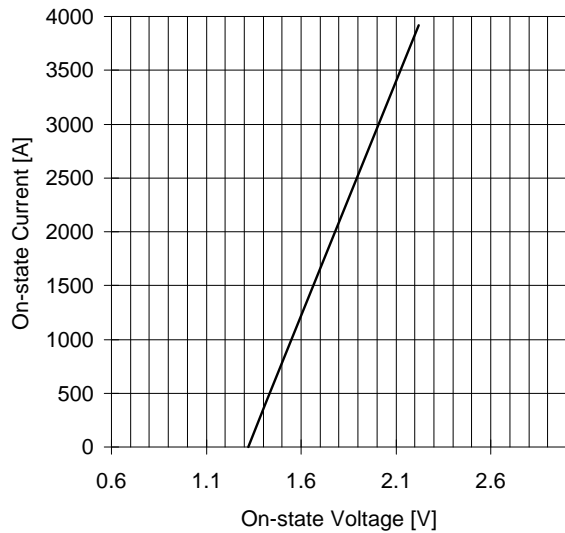

SURGE CHARACTERISTIC
T_j = 125 °C

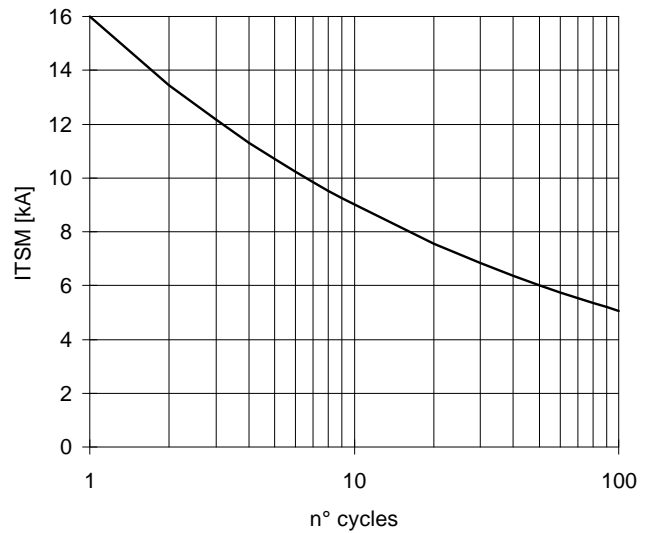

TRANSIENT THERMAL IMPEDANCE
DOUBLE SIDE COOLED

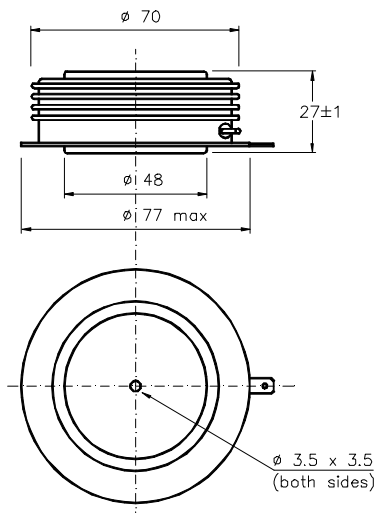
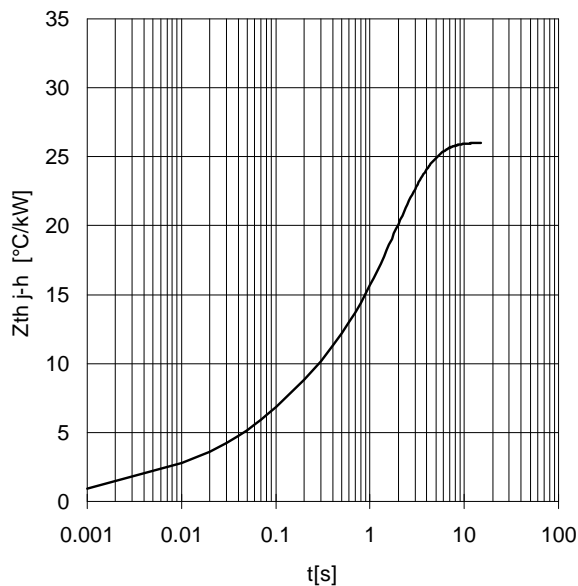

Dimensions
in mm

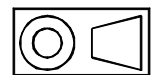

Cathode terminal type DIN 46244 - A 4.8 - 0.8

Gate terminal type AMP 60598 - 1

All the characteristics given in this data sheet are guaranteed only with uniform clamping force, cleaned and lubricated heatsink, surfaces with flatness < .03 mm and roughness < 2 μm.

In the interest of product improvement ANSALDO reserves the right to change any data given in this data sheet at any time without previous notice.

If not stated otherwise the maximum value of ratings (symbols over shaded background) and characteristics is reported.

Distributed by

