

# BCR30GM

MEDIUM POWER USE  
INSULATED TYPE, GLASS PASSIVATION TYPE

BCR30GM



- **IT (RMS)** ..... 30A
- **VDRM** ..... 400V/600V
- **IFGT I , IRGT I , IRGT III** ..... 50mA
- **Viso** ..... 2200V
- **UL Recognized: File No. E80276**

OUTLINE DRAWING

Dimensions  
in mm

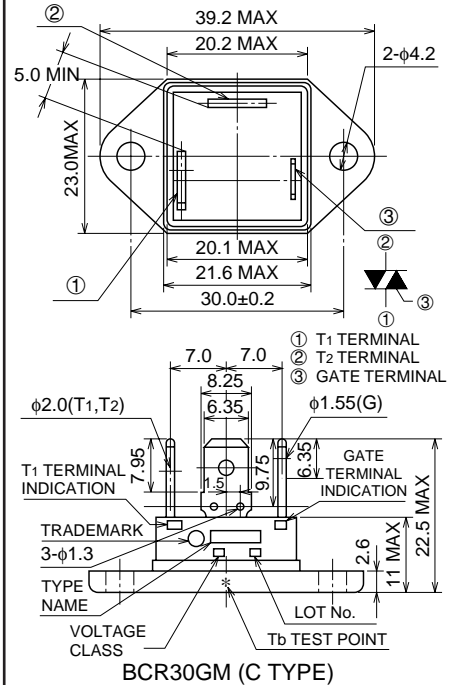

## APPLICATION

Contactless AC switches, light dimmer,  
on/off and speed control of small induction motors, on/off control of copier lamps,  
microwave ovens

## MAXIMUM RATINGS

Symbol	Parameter	Voltage class		Unit
		8	12	
VDRM	Repetitive peak off-state voltage*1	400	600	V
VDSM	Non-repetitive peak off-state voltage*1	500	720	V

Symbol	Parameter	Conditions	Ratings	Unit
IT (RMS)	RMS on-state current	Commercial frequency, sine full wave 360° conduction, T <sub>b</sub> =60°C	30	A
ITSM	Surge on-state current	60Hz sinewave 1 full cycle, peak value, non-repetitive	300	A
I <sup>2</sup> <sub>t</sub>	I <sup>2</sup> <sub>t</sub> for fusing	Value corresponding to 1 cycle of half wave 60Hz, surge on-state current	375	A <sup>2</sup> s
PGM	Peak gate power dissipation		5	W
PG (AV)	Average gate power dissipation		0.5	W
VGM	Peak gate voltage		10	V
IGM	Peak gate current		2	A
T <sub>j</sub>	Junction temperature		-40 ~ +125	°C
T <sub>stg</sub>	Storage temperature		-40 ~ +125	°C
—	Mounting torque	Screw M4	15	kg-cm
			1.47	N-cm
—	Weight	Typical value	26	g
Viso	Isolation voltage	T <sub>a</sub> =25°C, AC 1 minute, T <sub>2</sub> · T <sub>1</sub> · G terminal to base	2200	V

\*1. Gate open.

# BCR30GM

MEDIUM POWER USE  
INSULATED TYPE, GLASS PASSIVATION TYPE

## ELECTRICAL CHARACTERISTICS

Symbol	Parameter	Test conditions	Limits			Unit	
			Min.	Typ.	Max.		
IDRM	Repetitive peak off-state current	T <sub>j</sub> =125°C, V <sub>DRM</sub> applied	—	—	3.0	mA	
VTM	On-state voltage	T <sub>b</sub> =25°C, I <sub>TM</sub> =45A, Instantaneous measurement	—	—	1.6	V	
VFGT I	Gate trigger voltage *2	T <sub>j</sub> =25°C, V <sub>D</sub> =6V, R <sub>L</sub> =6Ω, R <sub>G</sub> =330Ω	I	—	—	2.5	V
VRGT I			II	—	—	2.5	V
VRGT III			III	—	—	2.5	V
IFGT I	Gate trigger current *2	T <sub>j</sub> =25°C, V <sub>D</sub> =6V, R <sub>L</sub> =6Ω, R <sub>G</sub> =330Ω	I	—	—	50	mA
IRGT I			II	—	—	50	mA
IRGT III			III	—	—	50	mA
VGD	Gate non-trigger voltage	T <sub>j</sub> =125°C, V <sub>D</sub> =1/2V <sub>DRM</sub>	0.2	—	—	V	
R <sub>th</sub> (j-b)	Thermal resistance	Junction to base *4	—	—	1.6	°C/W	
(dv/dt) <sub>c</sub>	Critical-rate of rise of off-state commutating voltage		*3	—	—	V/μs	

\*2. Measurement using the gate trigger characteristics measurement circuit.  
 \*3. The critical-rate of rise of the off-state commutating voltage is shown in the table below.  
 \*4. The contact thermal resistance R<sub>th</sub> (b-f) in case of greasing is 0.5°C/W.

Voltage class	V <sub>DRM</sub> (V)	(dv/dt) <sub>c</sub>			Test conditions	Commutating voltage and current waveforms (inductive load)
		Symbol	Min.	Unit		
8	400	R	—	V/μs	1. Junction temperature T <sub>j</sub> =125°C 2. Rate of decay of on-state commutating current (di/dt) <sub>c</sub> =-16A/ms 3. Peak off-state voltage V <sub>D</sub> =400V	
		L	20			
12	600	R	—			
		L	20			

## PERFORMANCE CURVES

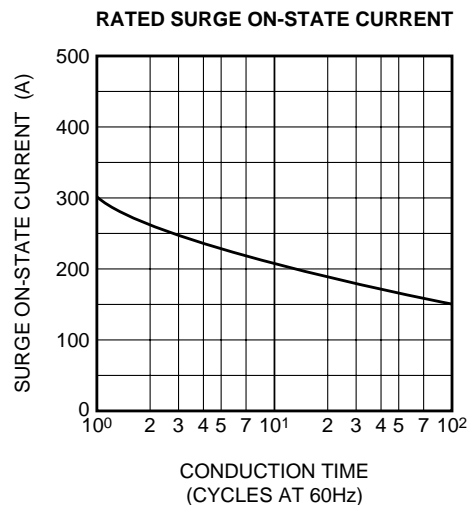
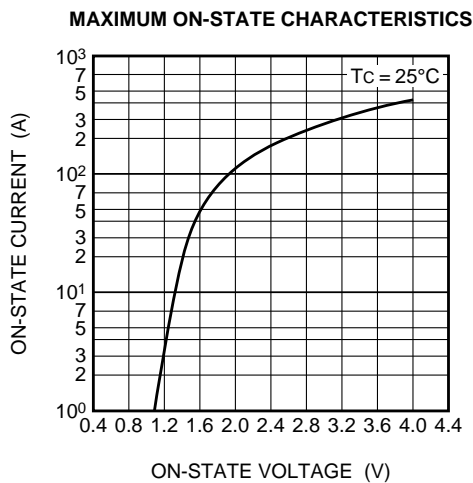

# BCR30GM

MEDIUM POWER USE  
INSULATED TYPE, GLASS PASSIVATION TYPE

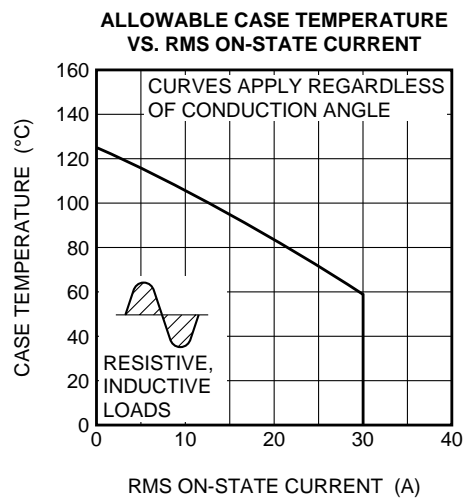
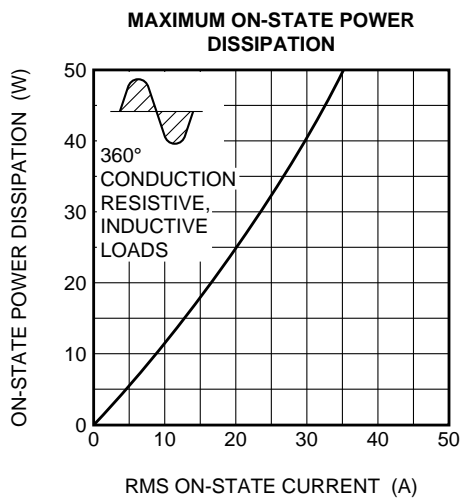
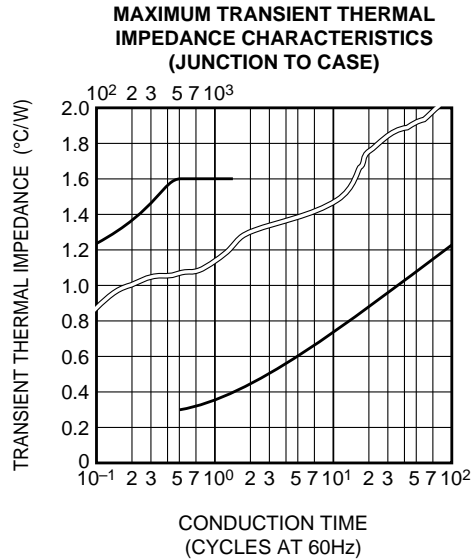
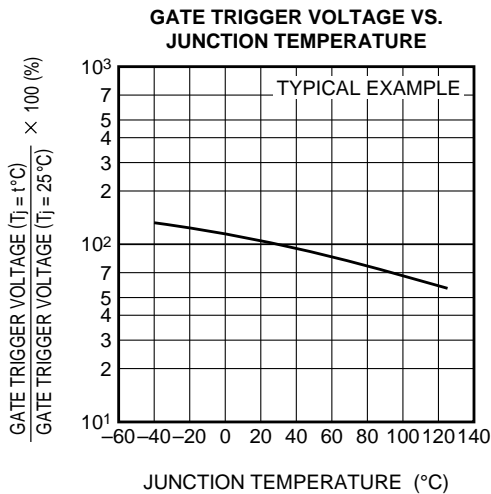
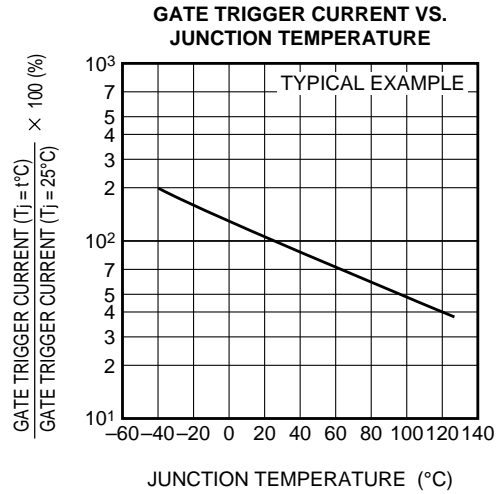
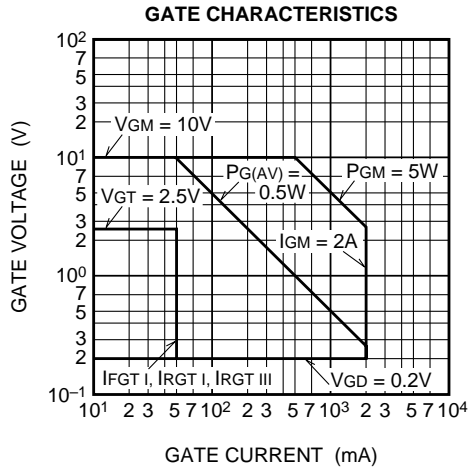

# BCR30GM

MEDIUM POWER USE  
INSULATED TYPE, GLASS PASSIVATION TYPE

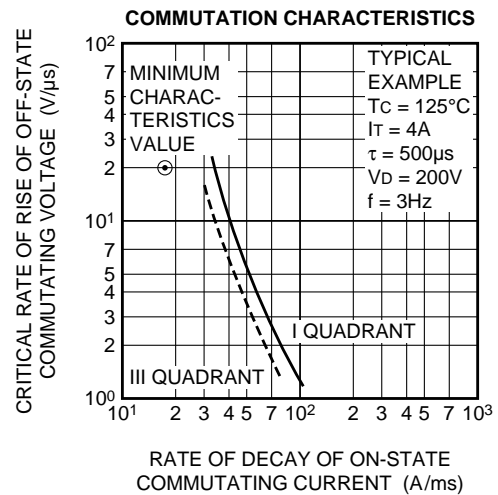
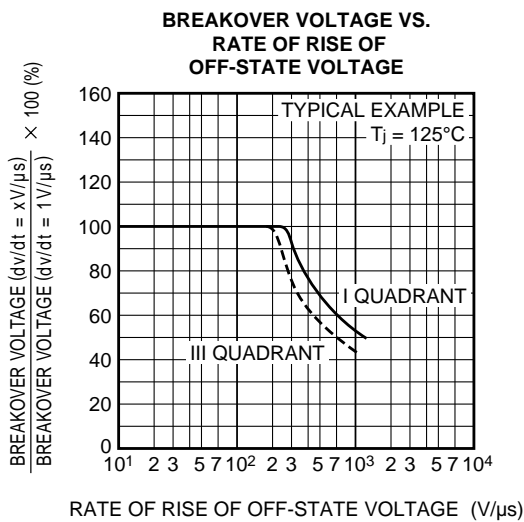
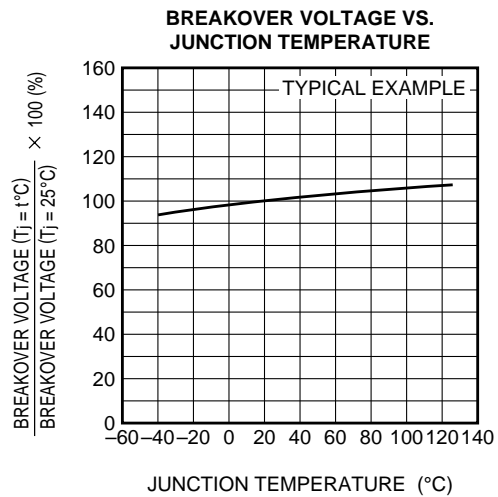
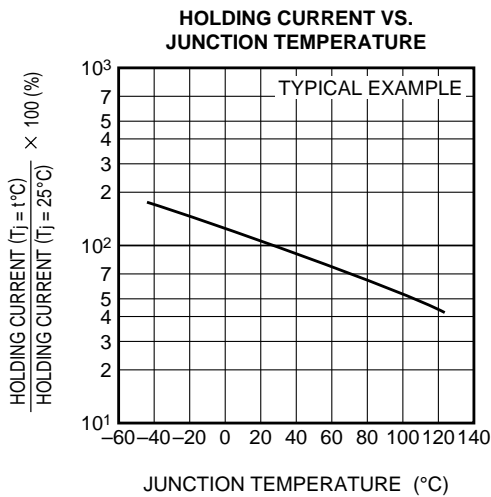
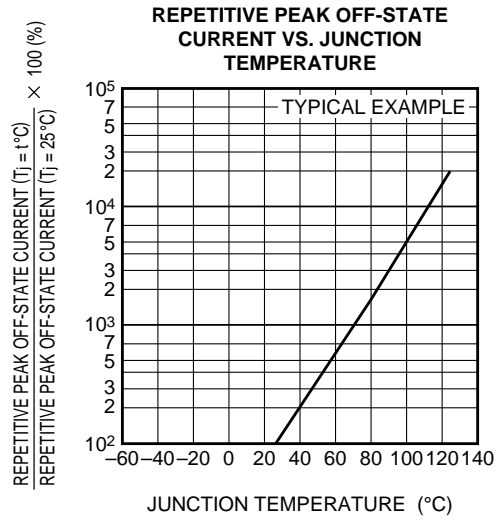
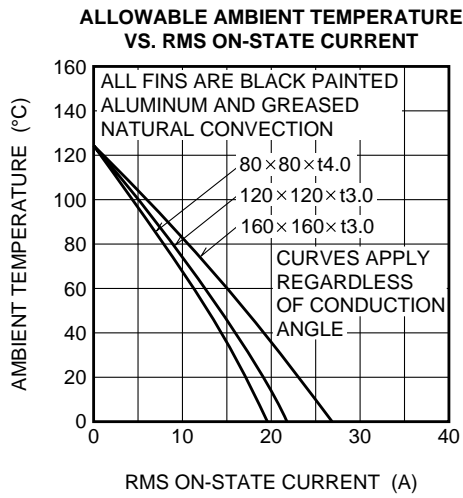

# BCR30GM

MEDIUM POWER USE  
INSULATED TYPE, GLASS PASSIVATION TYPE

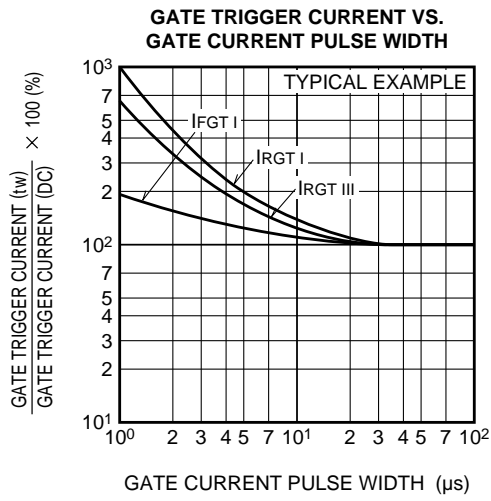

**GATE TRIGGER CHARACTERISTICS TEST CIRCUITS**

