

$$V_{DS} = 50 \text{ V}$$

$$I_D = 200 \text{ A}$$

$$R_{DS(on)} = 3.0 \text{ m}\Omega$$

- Power module
- Single switch
- N channel
- Enhancement mode
- Package with insulated metal base plate
- Package outline/Circuit diagram: 1¹⁾

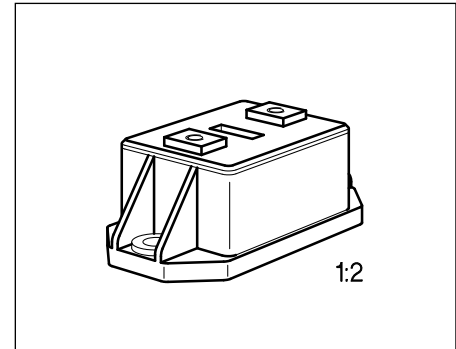

Type	Ordering Code
BSM 101 AR	C67076-S1018-A2

Maximum Ratings

Parameter	Symbol	Values	Unit
Drain-source voltage	V_{DS}	50	V
Drain-gate voltage, $R_{GS} = 20 \text{ k}\Omega$	V_{DGR}	50	
Gate-source voltage	V_{GS}	± 20	
Continuous drain current, $T_C = 105 \text{ }^\circ\text{C}$	I_D	200	A
Pulsed drain current, $T_C = 105 \text{ }^\circ\text{C}$	$I_{D \text{ puls}}$	600	
Operating and storage temperature range	T_j, T_{stg}	$- 55 \dots + 150$	$^\circ\text{C}$
Power dissipation, $T_C = 25 \text{ }^\circ\text{C}$	P_{tot}	700	W
Thermal resistance, chip-case	R_{thJC}	≤ 0.18	K/W
Insulation test voltage ²⁾ , $t = 1 \text{ min.}$	V_{is}	2500	V_{ac}
Creepage distance, drain-source	–	16	mm
Clearance, drain-source	–	11	
DIN humidity category, DIN 40 040	–	F	–
IEC climatic category, DIN IEC 68-1	–	55/150/56	–

¹⁾ See chapter Package Outline and Circuit Diagrams.

²⁾ Insulation test voltage between drain and base plate referred to standard climate 23/50 in acc. with DIN 50 014, IEC 146, para. 492.1.

Electrical Characteristics

at $T_j = 25\text{ °C}$, unless otherwise specified.

Parameter	Symbol	Values			Unit
		min.	typ.	max.	

Static Characteristics

Drain-source breakdown voltage $V_{GS} = 0, I_D = 0.25\text{ mA}$	$V_{(BR)DSS}$	50	–	–	V
Gate threshold voltage $V_{GS} = V_{DS}, I_D = 1\text{ mA}$	$V_{GS(th)}$	2.1	3.0	4.0	
Zero gate voltage drain current $V_{DS} = 50\text{ V}, V_{GS} = 0$ $T_j = 25\text{ °C}$ $T_j = 125\text{ °C}$	I_{DSS}	– –	50 300	250 1000	μA
Gate-source leakage current $V_{GS} = 20\text{ V}, V_{DS} = 0$	I_{GSS}	–	10	100	nA
Drain-source on-state resistance $V_{GS} = 10\text{ V}, I_D = 200\text{ A}$	$R_{DS(on)}$	–	2.6	3.0	m Ω

Dynamic Characteristics

Forward transconductance $V_{DS} \geq 2 \times I_D \times R_{DS(on)\text{ max.}}, I_D = 200\text{ A}$	g_{fs}	156	200	–	S
Input capacitance $V_{GS} = 0, V_{DS} = 25\text{ V}, f = 1\text{ MHz}$	C_{iss}	–	18	24	nF
Output capacitance $V_{GS} = 0, V_{DS} = 25\text{ V}, f = 1\text{ MHz}$	C_{oss}	–	9	12	
Reverse transfer capacitance $V_{GS} = 0, V_{DS} = 25\text{ V}, f = 1\text{ MHz}$	C_{rss}	–	3	4	
Turn-on Time t_{on} ($t_{on} = t_{d(on)} + t_r$) $V_{CC} = 40\text{ V}, V_{GS} = 10\text{ V}$ $I_D = 200\text{ A}, R_G = 3.3\text{ }\Omega$	$t_{d(on)}$	–	280	–	ns
	t_r	–	220	–	
Turn-off Time t_{off} ($t_{off} = t_{d(off)} + t_f$) $V_{CC} = 40\text{ V}, V_{GS} = 10\text{ V}$ $I_D = 200\text{ A}, R_G = 3.3\text{ }\Omega$	$t_{d(off)}$	–	220	–	
	t_f	–	60	–	

Electrical Characteristics (cont'd)

at $T_j = 25\text{ °C}$, unless otherwise specified.

Parameter	Symbol	Values			Unit
		min.	typ.	max.	

Reverse diode

Continuous reverse drain current $T_C = 25\text{ °C}$	I_S	–	–	200	A
Pulsed reverse drain current $T_C = 25\text{ °C}$	I_{SM}	–	–	600	
Diode forward on-voltage $I_F = 400\text{ A}$, $V_{GS} = 0$	V_{SD}		1.25	1.6	V
Reverse recovery time $I_F = I_S$, $di_F/dt = 100\text{ A}/\mu\text{s}$, $V_R = 30\text{ V}$	t_{rr}		400	–	ns
Reverse recovery charge $I_F = I_S$, $di_F/dt = 100\text{ A}/\mu\text{s}$, $V_R = 30\text{ V}$	Q_{rr}		3.5		μC

Characteristics at $T_j = 25^\circ\text{C}$, unless otherwise specified.

Power dissipation $P_{\text{tot}} = f(T_C)$
parameter: $T_j = 150^\circ\text{C}$

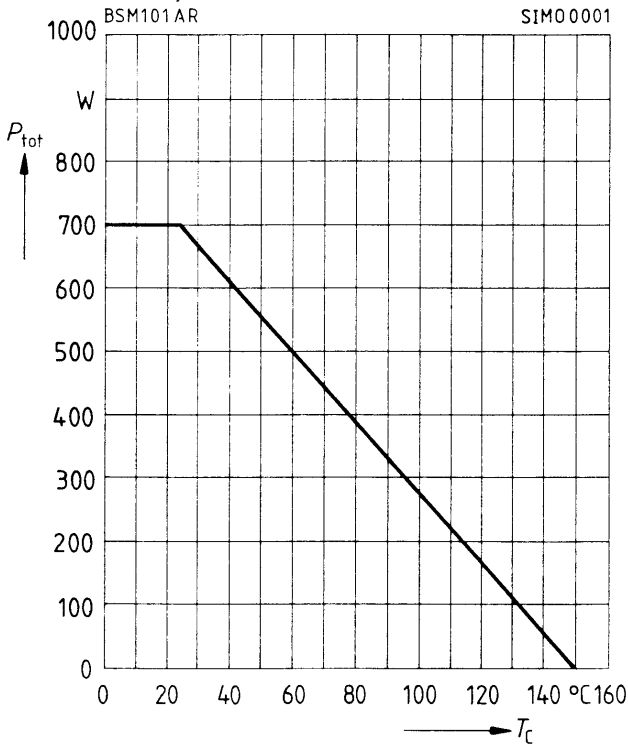

Typ. output characteristics $I_D = f(V_{\text{DS}})$
parameter: = 80 μs pulse test

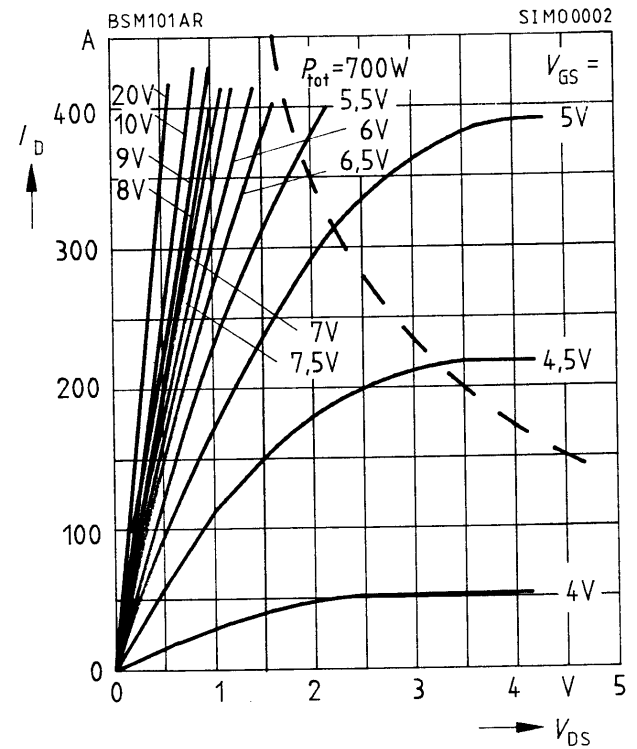

Safe operating area $I_D = f(V_{\text{DS}})$
parameter: single pulse, $T_C = 25^\circ\text{C}$,
 $T_j \leq 150^\circ\text{C}$

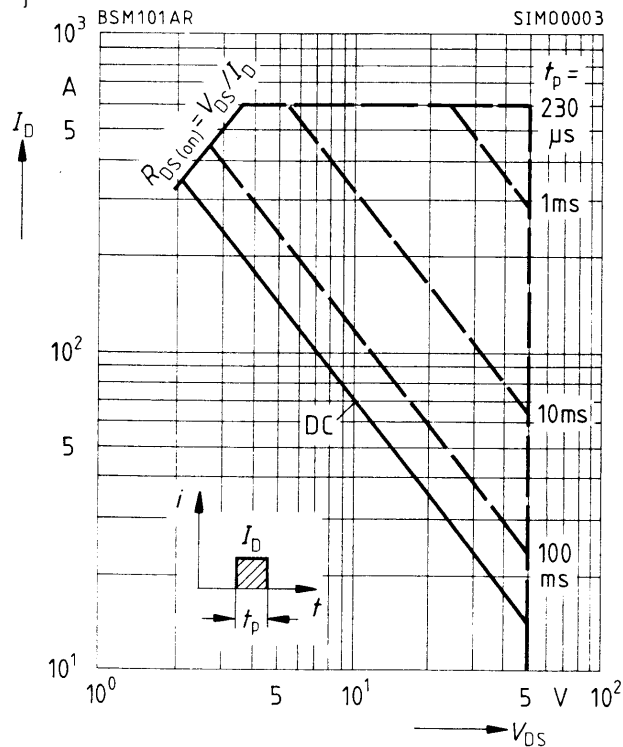

Typ. transfer characteristic $I_D = f(V_{\text{GS}})$
parameter: = 80 μs pulse test, $V_{\text{DS}} = 25\text{V}$

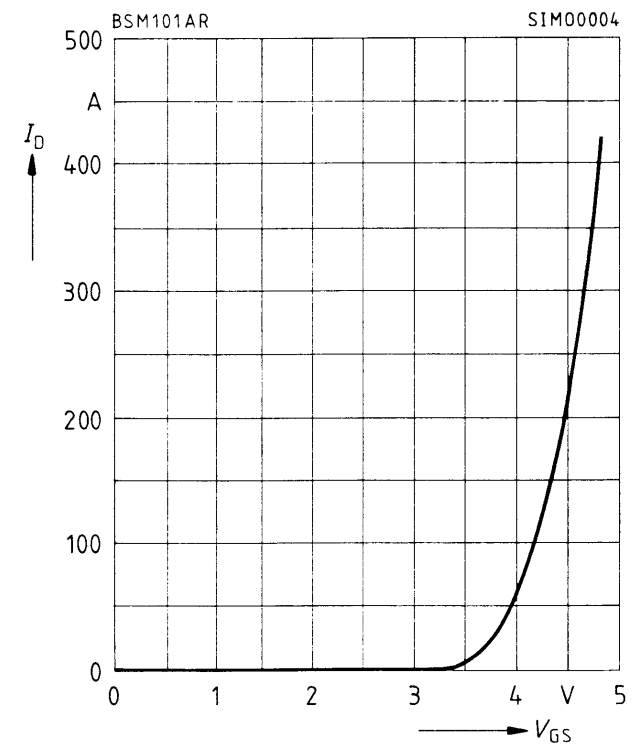

Continuous drain-source current

$I_D = f(T_C)$

parameter: $V_{GS} \geq 10\text{ V}$, $T_j = 150\text{ }^\circ\text{C}$

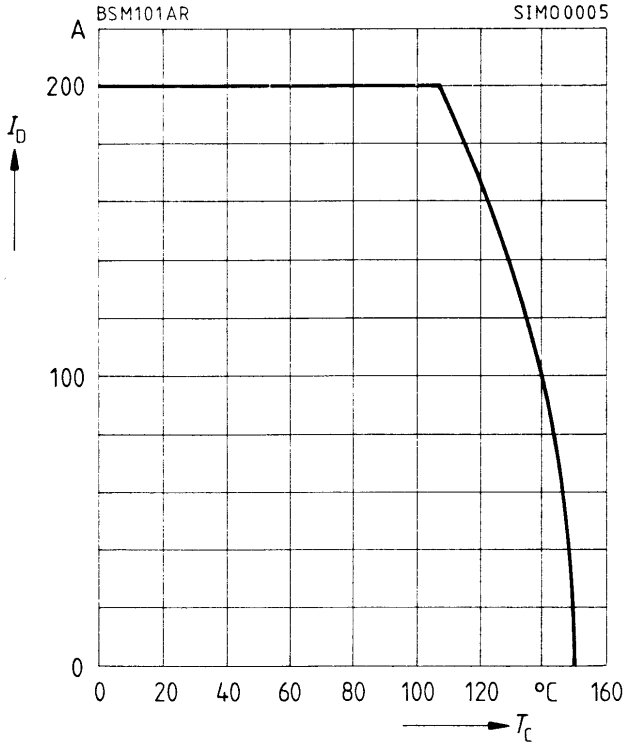

Drain-source breakdown voltage

$V_{(BR)DSS} = b \times V_{(BR)DSS}(25\text{ }^\circ\text{C})$

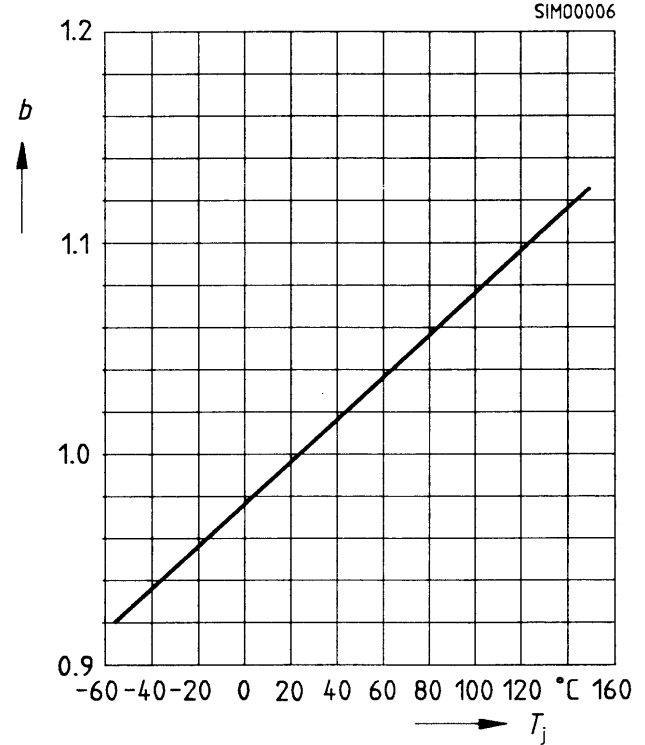

Drain source on-state resistance

$R_{DS(on)} = f(I_D)$

parameter: V_{GS}

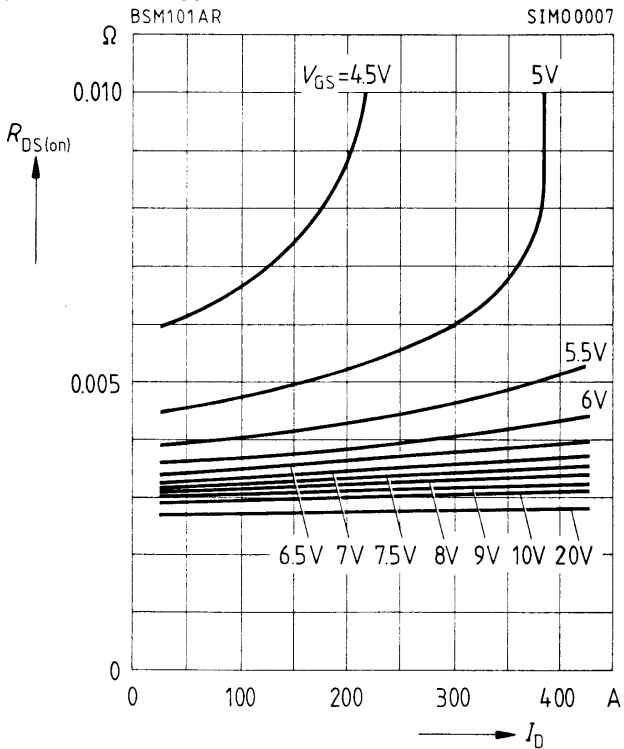

Drain source on-state resistance

$R_{DS(on)} = f(T_j)$

parameter: $I_D = 200\text{ A}$; $V_{GS} = 10\text{ V}$

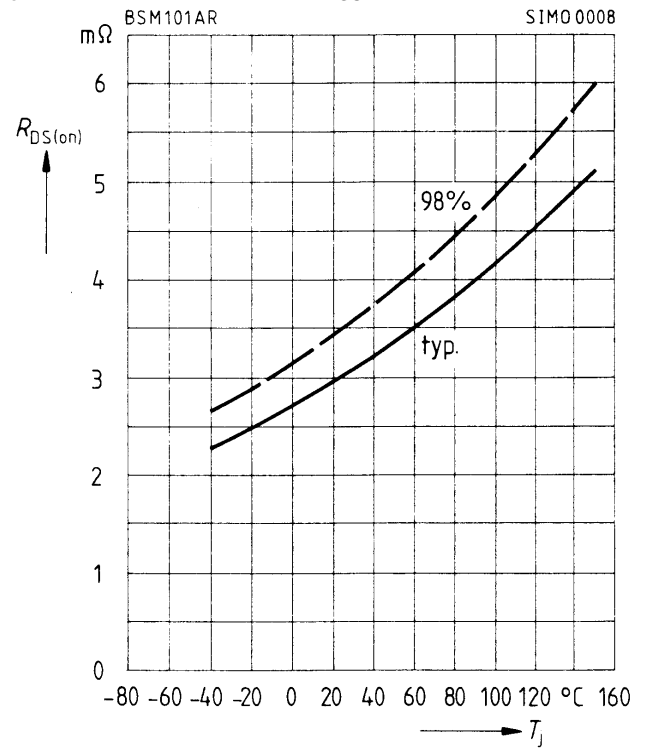

Typ. capacitances $C = f(V_{DS})$
 parameter: $V_{GS} = 0, f = 1 \text{ MHz}$

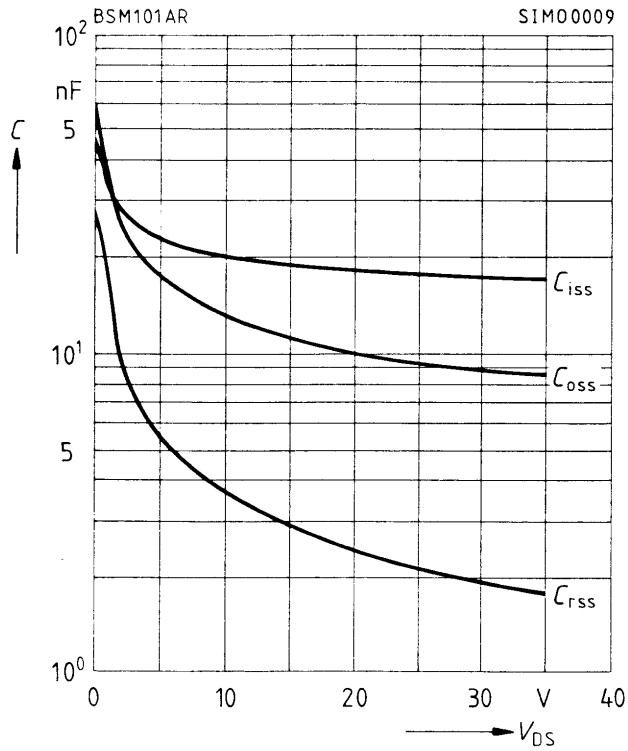

Gate threshold voltage $V_{GS(th)} = f(T_j)$
 parameter: $V_{DS} = V_{GS}, I_D = 1 \text{ mA}$
 (spread)

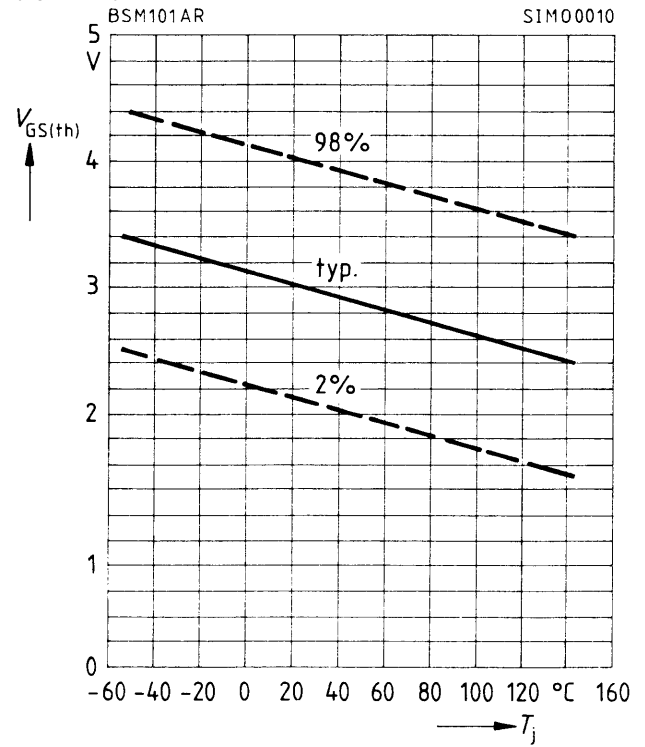

Transient thermal impedance $Z_{thJC} = f(t_p)$

parameter: $D = t_p/T$

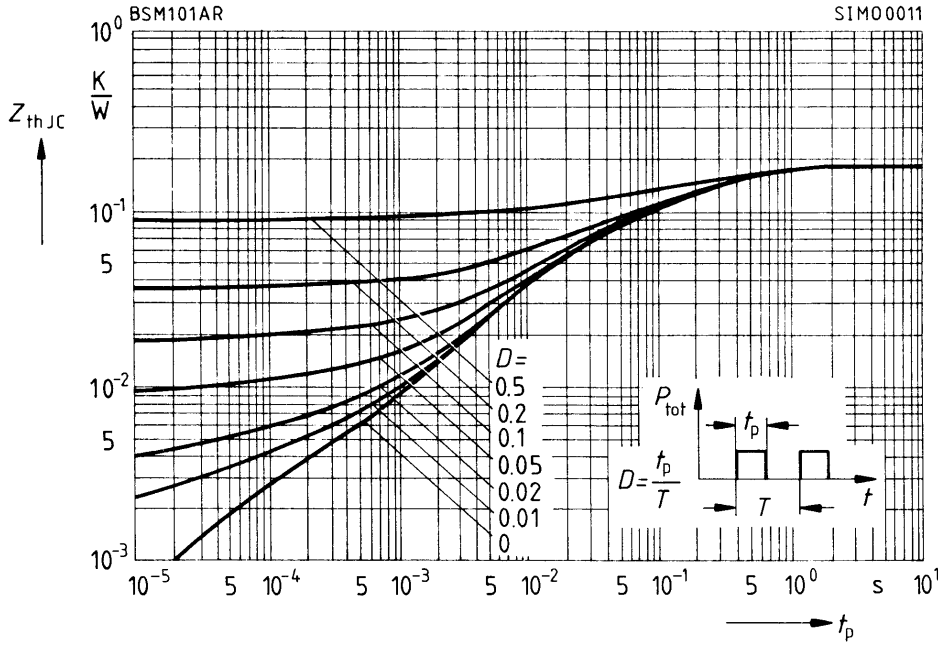

Typ. gate charge $V_{GS} = f(Q_{Gate})$

parameter: $I_{Dpuls} = 330$ A

