

Höchstzulässige Werte / Maximum rated values

Elektrische Eigenschaften / Electrical properties

Kollektor-Emitter-Sperrspannung collector-emitter voltage		V_{CES}	600	V
Kollektor-Dauergleichstrom DC-collector current	$T_C= 45^{\circ}C$	$I_{C,nom.}$	200	A
	$T_C= 25^{\circ}C$	I_C	226	A
Periodischer Kollektor Spitzenstrom repetitive peak collector current	$t_p= 1ms, T_C= 45^{\circ}C$	I_{CRM}	400	A
Gesamt-Verlustleistung total power dissipation	$T_C= 25^{\circ}C, \text{ Transistor}$	P_{tot}	700	W
Gate-Emitter-Spitzenspannung gate-emitter peak voltage		V_{GES}	+/- 20V	V
Dauergleichstrom DC forward current		I_F	200	A
Periodischer Spitzenstrom repetitive peak forw. current	$t_p= 1ms$	I_{FRM}	400	A
Grenzlastintegral der Diode I^2t - value, Diode	$V_R= 0V, t_p= 10ms, T_{vj}= 125^{\circ}C$	I^2t	8.450	A ² s
Isolations-Prüfspannung insulation test voltage	RMS, $f= 50Hz, t= 1min.$	V_{ISOL}	2,5	kV

Charakteristische Werte / Characteristic values

Transistor / Transistor

			min.	typ.	max.	
Kollektor-Emitter Sättigungsspannung collector-emitter saturation voltage	$I_C= 200A, V_{GE}= 15V, T_{vj}= 25^{\circ}C$	$V_{CE sat}$	-	1,95	2,45	V
	$I_C= 200A, V_{GE}= 15V, T_{vj}= 125^{\circ}C$		-	2,20	-	V
Gate-Schwellenspannung gate threshold voltage	$I_C= 4,0mA, V_{CE}= V_{GE}, T_{vj}= 25^{\circ}C$	$V_{GE(th)}$	4,5	5,5	6,5	V
Eingangskapazität input capacitance	$f= 1MHz, T_{vj}= 25^{\circ}C, V_{CE}= 25V, V_{GE}= 0V$	C_{ies}	-	9	-	nF
Rückwirkungskapazität reverse transfer capacitance	$f= 1MHz, T_{vj}= 25^{\circ}C, V_{CE}= 25V, V_{GE}= 0V$	C_{res}	-	0,8	-	nF
Kollektor-Emitter Reststrom collector-emitter cut-off current	$V_{CE}= 600V, V_{GE}= 0V, T_{vj}= 25^{\circ}C$	I_{CES}	-	1	500	μA
	$V_{CE}= 600V, V_{GE}= 0V, T_{vj}= 125^{\circ}C$		-	1	-	mA
Gate-Emitter Reststrom gate-emitter leakage current	$V_{CE}= 0V, V_{GE}= 20V, T_{vj}= 25^{\circ}C$	I_{GES}	-	-	400	nA

prepared by: Andreas Vetter

date of publication: 2000-04-26

approved by: Michael Hornkamp

revision: 1



Charakteristische Werte / Characteristic values

Transistor / Transistor

			min.	typ.	max.	
Einschaltverzögerungszeit (ind. Last) turn on delay time (inductive load)	$I_C=200A, V_{CC}=300V$ $V_{GE}=\pm 15V, R_G=1,5\Omega, T_{vj}=25^\circ C$	$t_{d,on}$	-	163	-	ns
	$V_{GE}=\pm 15V, R_G=1,5\Omega, T_{vj}=125^\circ C$		-	180	-	ns
Anstiegszeit (induktive Last) rise time (inductive load)	$I_C=200A, V_{CC}=300V$ $V_{GE}=\pm 15V, R_G=1,5\Omega, T_{vj}=25^\circ C$	t_r	-	43	-	ns
	$V_{GE}=\pm 15V, R_G=1,5\Omega, T_{vj}=125^\circ C$		-	49	-	ns
Abschaltverzögerungszeit (ind. Last) turn off delay time (inductive load)	$I_C=200A, V_{CC}=300V$ $V_{GE}=\pm 15V, R_G=1,5\Omega, T_{vj}=25^\circ C$	$t_{d,off}$	-	253	-	ns
	$V_{GE}=\pm 15V, R_G=1,5\Omega, T_{vj}=125^\circ C$		-	285	-	ns
Fallzeit (induktive Last) fall time (inductive load)	$I_C=200A, V_{CC}=300V$ $V_{GE}=\pm 15V, R_G=1,5\Omega, T_{vj}=25^\circ C$	t_f	-	33	-	ns
	$V_{GE}=\pm 15V, R_G=1,5\Omega, T_{vj}=125^\circ C$		-	41	-	ns
Einschaltverlustenergie pro Puls turn-on energy loss per pulse	$I_C=200A, V_{CC}=300V, V_{GE}=15V$ $R_G=1,5\Omega, T_{vj}=125^\circ C, L_\sigma=15nH$	E_{on}	-	4,6	-	mJ
Abschaltverlustenergie pro Puls turn-off energy loss per pulse	$I_C=200A, V_{CC}=300V, V_{GE}=15V$ $R_G=1,5\Omega, T_{vj}=125^\circ C, L_\sigma=15nH$	E_{off}	-	6,3	-	mJ
Kurzschlußverhalten SC Data	$t_p \leq 10\mu sec, V_{GE} \leq 15V$ $T_{vj} \leq 125^\circ C, V_{CC}=360V, V_{CEmax} = V_{CES} - L_{\sigma CE} \cdot di/dt$	I_{SC}	-	900	-	A
Modulinduktivität stray inductance module		$L_{\sigma CE}$	-	28	-	nH
Modul-Leitungswiderstand, Anschlüsse - Chip lead resistance, terminals - chip	$T_c=25^\circ C$	R_{CC+EE}	-	1,8	-	mΩ

Charakteristische Werte / Characteristic values

Diode / Diode

			min.	typ.	max.	
Durchlaßspannung forward voltage	$I_F=200A, V_{GE}=0V, T_{vj}=25^\circ C$	V_F	-	1,25	1,6	V
	$I_F=200A, V_{GE}=0V, T_{vj}=125^\circ C$		-	1,20	-	V
Rückstromspitze peak reverse recovery current	$I_F=200A, -di_F/dt=4000A/\mu s$ $V_R=300V, V_{GE}=-10V, T_{vj}=25^\circ C$	I_{RM}	-	154	-	A
	$V_R=300V, V_{GE}=-10V, T_{vj}=125^\circ C$		-	188	-	A
Sperrverzögerungsladung recovered charge	$I_F=200A, -di_F/dt=4000A/\mu s$ $V_R=300V, V_{GE}=-10V, T_{vj}=25^\circ C$	Q_r	-	12,1	-	μC
	$V_R=300V, V_{GE}=-10V, T_{vj}=125^\circ C$		-	19,7	-	μC
Abschaltenergie pro Puls reverse recovery energy	$I_F=200A, -di_F/dt=4000A/\mu s$ $V_R=300V, V_{GE}=-10V, T_{vj}=25^\circ C$	E_{rec}	-	-	-	mJ
	$V_R=300V, V_{GE}=-10V, T_{vj}=125^\circ C$		-	4,1	-	mJ

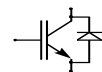

Thermische Eigenschaften / Thermal properties

			min.	typ.	max.	
Innerer Wärmewiderstand thermal resistance, junction to case	Transistor / transistor, DC	R_{thJC}	-	-	0,18	K/W
	Diode / diode, DC		-	-	0,32	K/W
Übergangs-Wärmewiderstand thermal resistance, case to heatsink	pro Modul / per module $\lambda_{Paste}= 1W/m^*K$ / $\lambda_{grease}= 1W/m^*K$	R_{thCK}	-	0,01	-	K/W
Höchstzulässige Sperrschichttemperatur maximum junction temperature		T_{vj}	-	-	150	°C
Betriebstemperatur operation temperature		T_{op}	-40	-	125	°C
Lagertemperatur storage temperature		T_{stg}	-40	-	125	°C

Mechanische Eigenschaften / Mechanical properties

Gehäuse, siehe Anlage case, see appendix						
Innere Isolation internal insulation				Al_2O_3		
CTI comperative tracking index				225		
Anzugsdrehmoment f. mech. Befestigung mounting torque	Schraube M5 screw M5	M	-15	4	+15	Nm %
Gewicht weight		G		310		g

Mit dieser technischen Information werden Halbleiterbauelemente spezifiziert, jedoch keine Eigenschaften zugesichert. Sie gilt in Verbindung mit den zugehörigen Technischen Erläuterungen.

This technical information specifies semiconductor devices but promises no characteristics. It is valid in combination with the belonging technical notes.



Ausgangskennlinie (typisch)
Output characteristic (typical)

$I_C = f(V_{CE})$
 $V_{GE} = 15V$

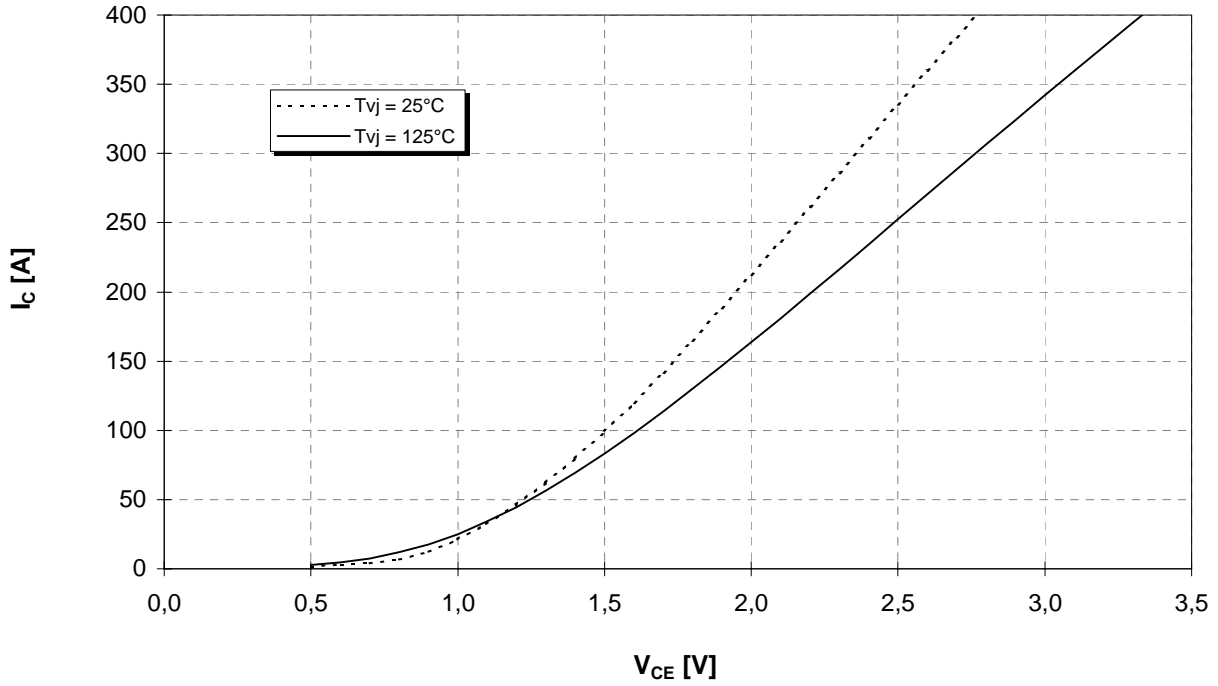

Ausgangskennlinienfeld (typisch)
Output characteristic (typical)

$I_C = f(V_{CE})$
 $T_{vj} = 125^\circ C$

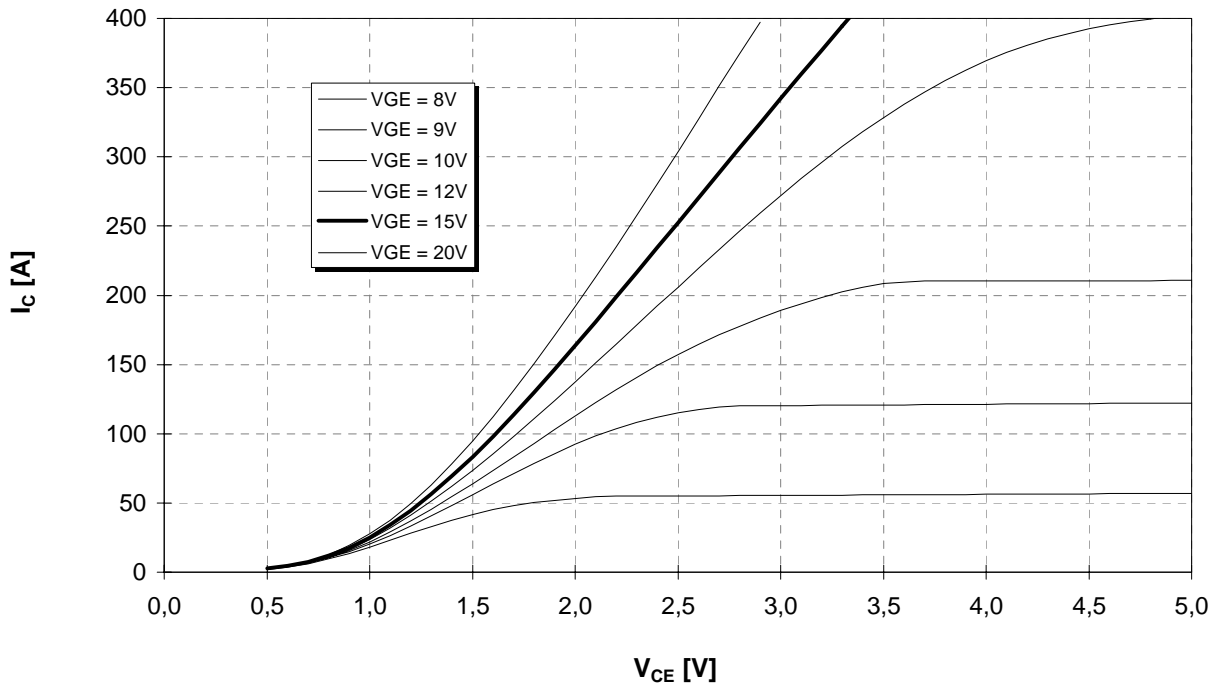



Übertragungscharakteristik (typisch)
Transfer characteristic (typical)

$I_C = f(V_{GE})$

$V_{CE} = 20V$

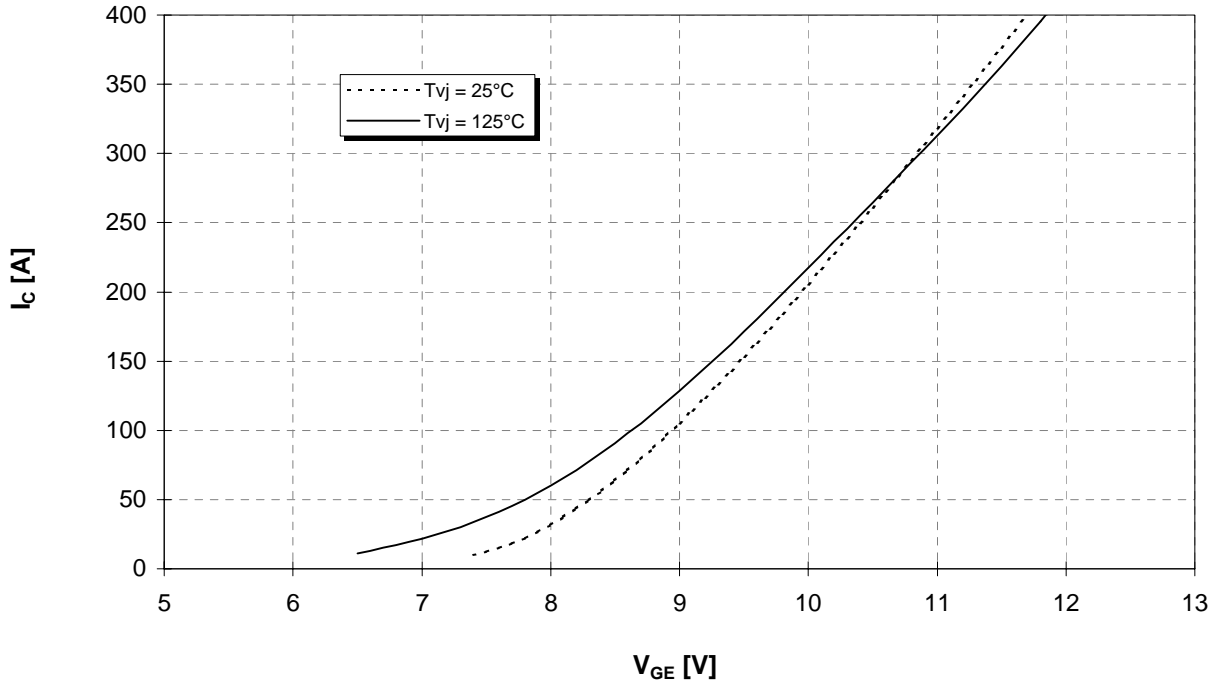

Durchlaßkennlinie der Inversdiode (typisch)
Forward characteristic of inverse diode (typical)

$I_F = f(V_F)$

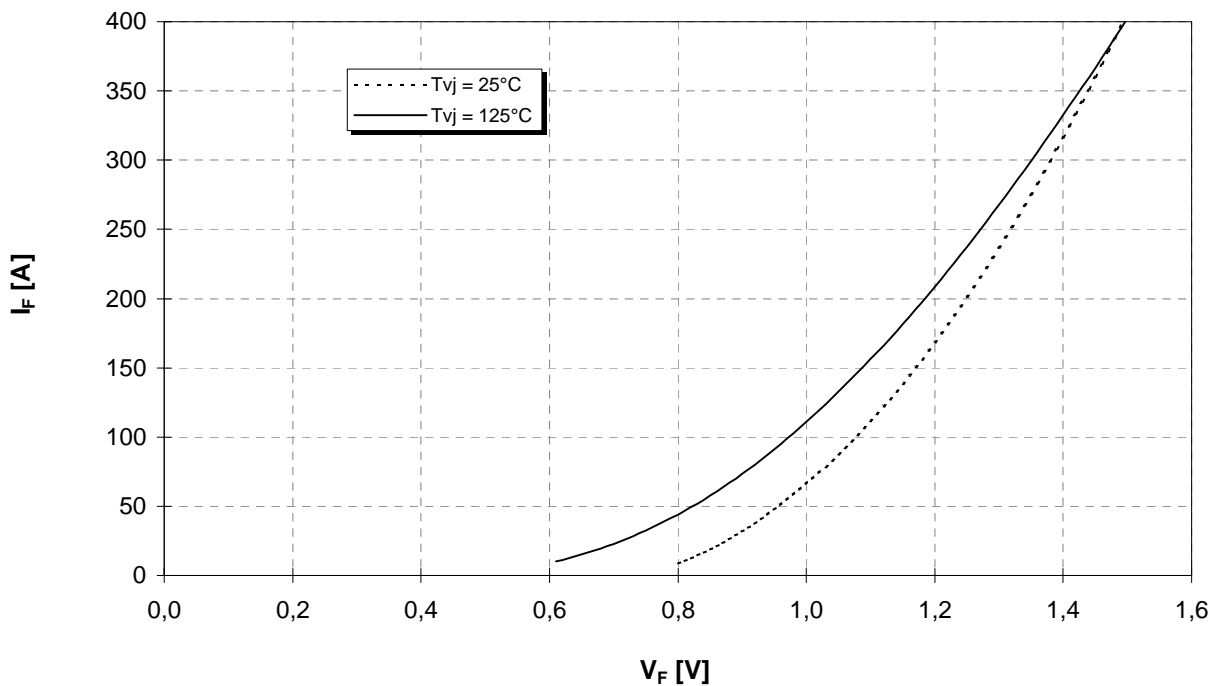



Schaltverluste (typisch)
Switching losses (typical)

$E_{on} = f(I_c), E_{off} = f(I_c), E_{rec} = f(I_c)$

$R_{G,on} = 1,5\Omega, R_{G,off} = 1,5\Omega, V_{CC} = 300V, T_{vj} = 125^\circ C$

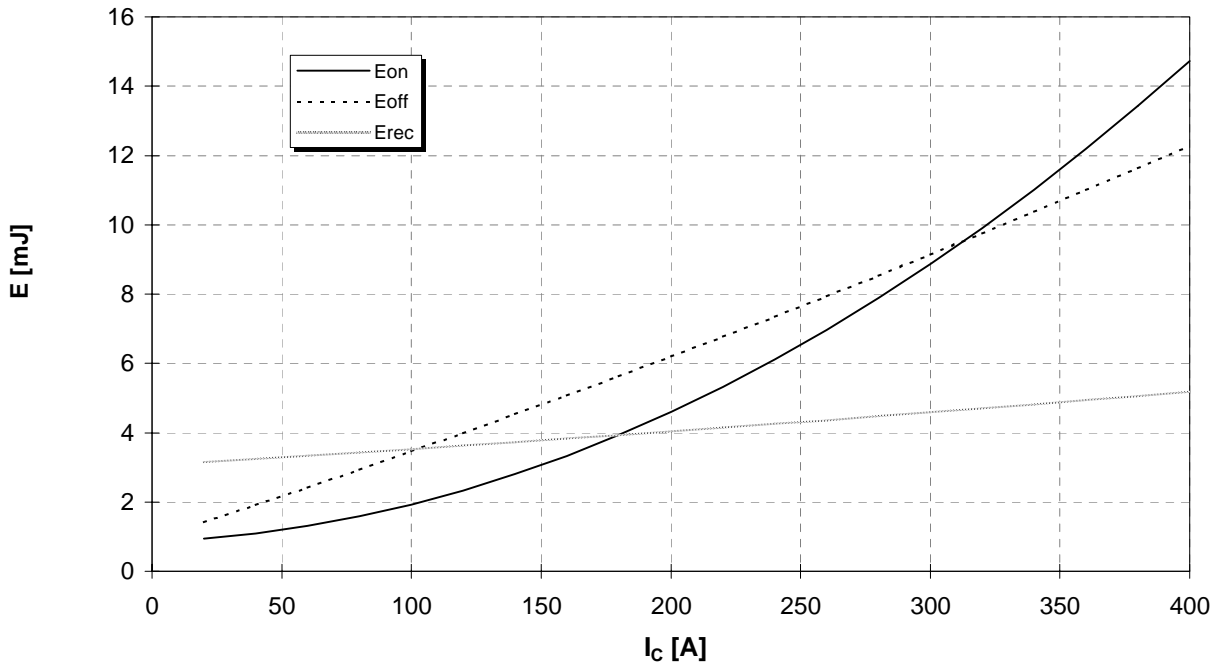

Schaltverluste (typisch)
Switching losses (typical)

$E_{on} = f(R_G), E_{off} = f(R_G), E_{rec} = f(R_G)$

$I_c = 200A, V_{CE} = 300V, T_{vj} = 125^\circ C$

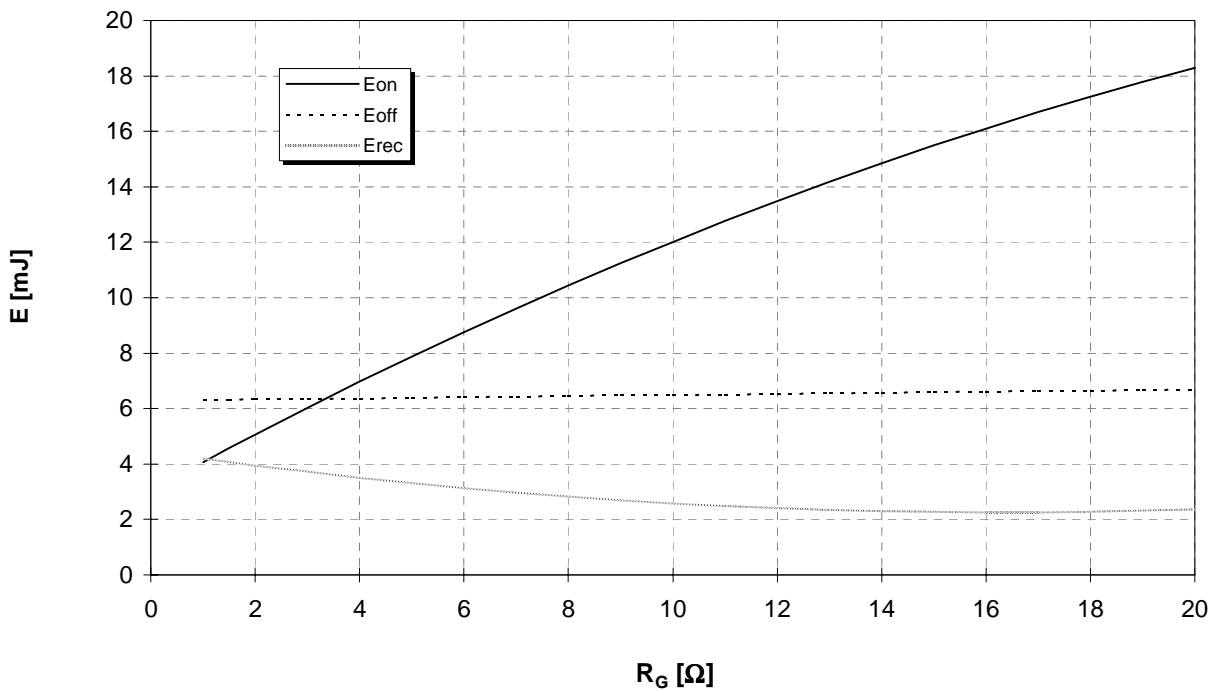



Transienter Wärmewiderstand
Transient thermal impedance

$Z_{thJC} = f(t)$

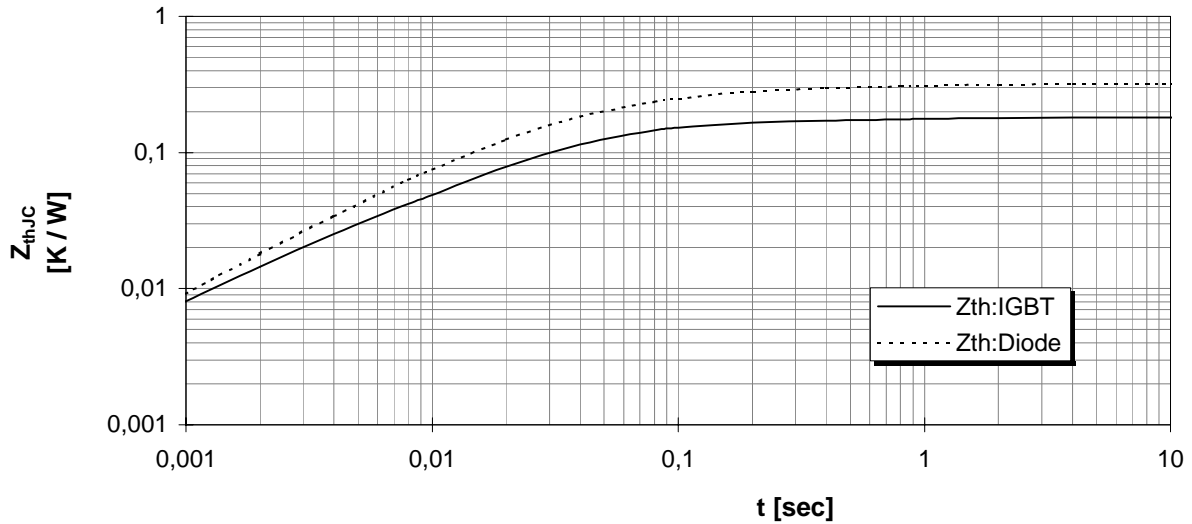

i	1	2	3	4
r_i [K/kW] : IGBT	7,6	94,3	63,4	14,6
τ_i [sec] : IGBT	0,0018	0,0240	0,0651	0,6626
r_i [K/kW] : Diode	112,8	108,2	67,9	31,1
τ_i [sec] : Diode	0,0487	0,0169	0,1069	0,9115

Sicherer Arbeitsbereich (RBSOA)

Reverse bias safe operation area (RBSOA)

$V_{GE} = +15V, R_{G,off} = 1,5\Omega, T_{vj} = 125^\circ C$

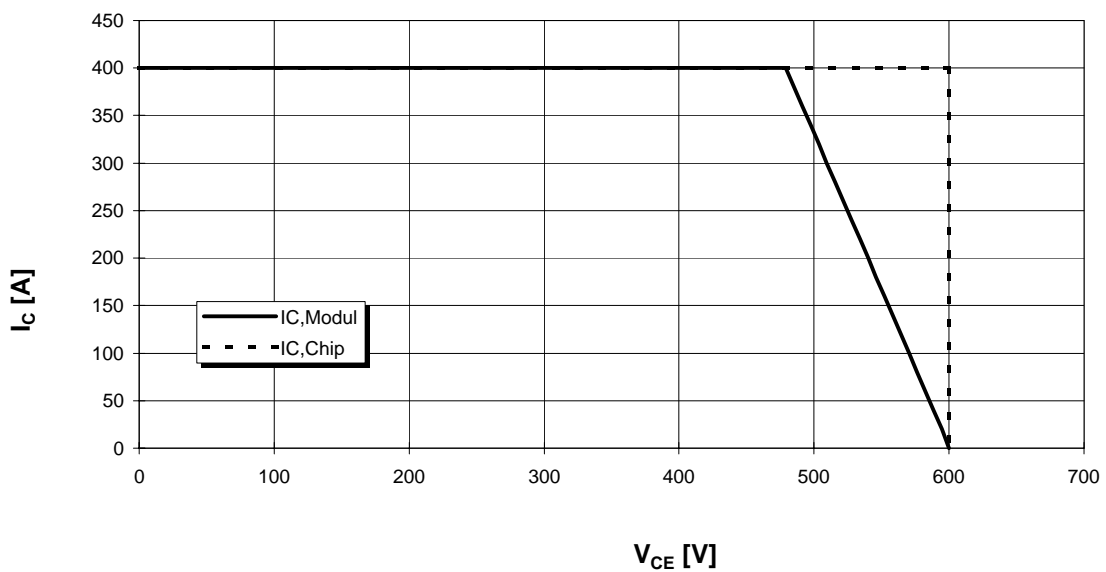



Gehäusemaße / Schaltbild
Package outline / Circuit diagram

Econo 3

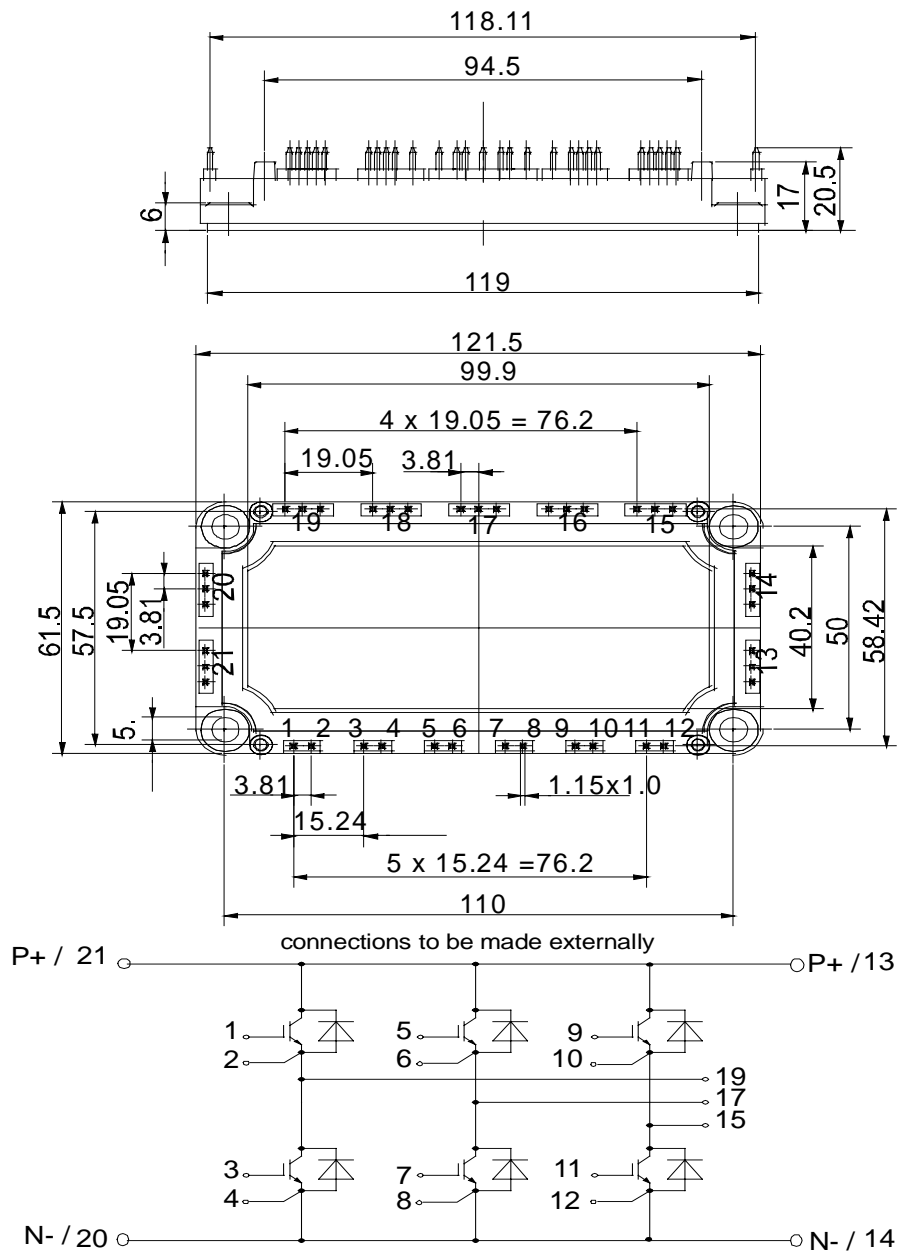

IS8