

MITSUBISHI IGBT MODULES

CM100E3U-24H

HIGH POWER SWITCHING USE
INSULATED TYPE

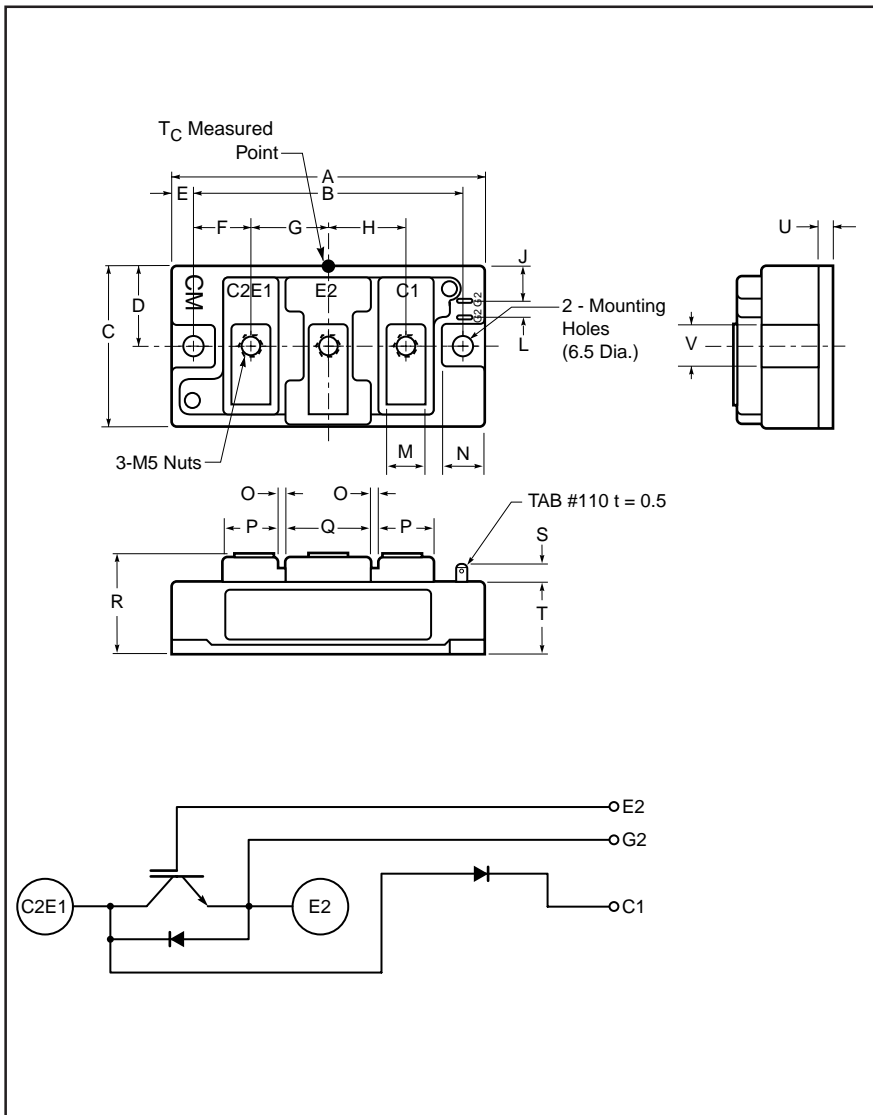

Outline Drawing and Circuit Diagram

Dimensions	Inches	Millimeters
A	3.7	94.0
B	3.15±0.01	80.0±0.25
C	1.89	48.0
D	0.94	24.0
E	0.28	7.0
F	0.67	17.0
G	0.91	23.0
H	0.91	23.0
J	0.43	11.0
L	0.16	4.0

Dimensions	Inches	Millimeters
M	0.47	12.0
N	0.53	13.5
O	0.1	2.5
P	0.63	16.0
Q	0.98	25.0
R	1.18 +0.04/-0.02	30.0 +1.0/-0.5
S	0.3	7.5
T	0.83	21.2
U	0.16	4.0
V	0.51	13.0



Description:

Mitsubishi IGBT Modules are designed for use in switching applications. Each module consists of one IGBT having a reverse-connected super-fast recovery free-wheel diode and an anode-collector connected super-fast recovery free-wheel diode. All components and interconnects are isolated from the heat sinking baseplate, offering simplified system assembly and thermal management.

Features:

- Low Drive Power
- Low $V_{CE(sat)}$
- Discrete Super-Fast Recovery Free-Wheel Diode
- High Frequency Operation
- Isolated Baseplate for Easy Heat Sinking

Application:

- Brake

Ordering Information:

Example: Select the complete module number you desire from the table - i.e. CM100E3U-24H is a 1200V (V_{CES}), 100 Ampere IGBT Module.

Type	Current Rating Amperes	V_{CES} Volts (x 50)
CM	100	24

CM100E3U-24H

HIGH POWER SWITCHING USE
INSULATED TYPEAbsolute Maximum Ratings, $T_j = 25\text{ }^\circ\text{C}$ unless otherwise specified

	Symbol	Ratings	Units
Junction Temperature	T_j	-40 to 150	$^\circ\text{C}$
Storage Temperature	T_{stg}	-40 to 125	$^\circ\text{C}$
Collector-Emitter Voltage (G-E SHORT)	V_{CES}	1200	Volts
Gate-Emitter Voltage (C-E SHORT)	V_{GES}	± 20	Volts
Collector Current ($T_c = 25^\circ\text{C}$)	I_C	100	Amperes
Peak Collector Current	I_{CM}	200*	Amperes
Emitter Current** ($T_c = 25^\circ\text{C}$)	I_E	100	Amperes
Peak Emitter Current**	I_{EM}	200*	Amperes
Maximum Collector Dissipation ($T_c = 25^\circ\text{C}$, $T_j \leq 150^\circ\text{C}$)	P_C	650	Watts
Mounting Torque, M5 Main Terminal	–	2.5 ~ 3.5	N · m
Mounting Torque, M6 Mounting	–	3.5 ~ 4.5	N · m
Weight	–	310	Grams
Isolation Voltage (Main Terminal to Baseplate, AC 1 min.)	V_{iso}	2500	Vrms

* Pulse width and repetition rate should be such that the device junction temperature (T_j) does not exceed $T_{j(max)}$ rating.

**Represents characteristics of the anti-parallel, emitter-to-collector free-wheel diode (FWDi).

Static Electrical Characteristics, $T_j = 25\text{ }^\circ\text{C}$ unless otherwise specified

Characteristics	Symbol	Test Conditions	Min.	Typ.	Max.	Units
Collector-Cutoff Current	I_{CES}	$V_{CE} = V_{CES}$, $V_{GE} = 0V$	–	–	1	mA
Gate Leakage Voltage	I_{GES}	$V_{GE} = V_{GES}$, $V_{CE} = 0V$	–	–	0.5	μA
Gate-Emitter Threshold Voltage	$V_{GE(th)}$	$I_C = 10\text{mA}$, $V_{CE} = 10V$	4.5	6	7.5	Volts
Collector-Emitter Saturation Voltage	$V_{CE(sat)}$	$I_C = 100\text{A}$, $V_{GE} = 15V$, $T_j = 25^\circ\text{C}$	–	2.9	3.7	Volts
		$I_C = 100\text{A}$, $V_{GE} = 15V$, $T_j = 125^\circ\text{C}$	–	2.85	–	Volts
Total Gate Charge	Q_G	$V_{CC} = 600V$, $I_C = 100\text{A}$, $V_{GE} = 15V$	–	375	–	nC
Emitter-Collector Voltage**	V_{EC}	$I_E = 100\text{A}$, $V_{GE} = 0V$	–	–	3.2	Volts
Emitter-Collector Voltage	V_{FM}	$I_F = 100\text{A}$, Clamp Diode Part	–	–	3.2	Volts

**Represents characteristics of the anti-parallel, emitter-to-collector free-wheel diode (FWDi).

Dynamic Electrical Characteristics, $T_j = 25\text{ }^\circ\text{C}$ unless otherwise specified

Characteristics	Symbol	Test Conditions	Min.	Typ.	Max.	Units	
Input Capacitance	C_{ies}		–	–	15	nF	
Output Capacitance	C_{oes}	$V_{CE} = 10V$, $V_{GE} = 0V$	–	–	5	nF	
Reverse Transfer Capacitance	C_{res}		–	–	3	nF	
Resistive Load	Turn-on Delay Time	$t_{d(on)}$	$V_{CC} = 600V$, $I_C = 100\text{A}$,	–	–	100	ns
	Rise Time	t_r	$V_{GE1} = V_{GE2} = 15V$,	–	–	200	ns
Switch Times	Turn-off Delay Time	$t_{d(off)}$	$R_G = 3.1\Omega$, Resistive	–	–	300	ns
	Fall Time	t_f	Load Switching Operation	–	–	350	ns
Diode Reverse Recovery Time**	t_{rr}	$I_E = 100\text{A}$, $di_E/dt = -200\text{A}/\mu\text{s}$	–	–	300	ns	
Diode Reverse Recovery Charge**	Q_{rr}	$I_E = 100\text{A}$, $di_E/dt = -200\text{A}/\mu\text{s}$	–	0.55	–	μC	
Diode Reverse Recovery Time	t_{rr}	$I_F = 100\text{A}$, Clamp Diode Part	–	–	300	ns	
Diode Reverse Recovery Charge	Q_{rr}	$di_F/dt = -200\text{A}/\mu\text{s}$	–	0.55	–	μC	

**Represents characteristics of the anti-parallel, emitter-to-collector free-wheel diode (FWDi).

CM100E3U-24H

HIGH POWER SWITCHING USE
INSULATED TYPE

Thermal and Mechanical Characteristics, $T_j = 25\text{ }^\circ\text{C}$ unless otherwise specified

Characteristics	Symbol	Test Conditions	Min.	Typ.	Max.	Units
Thermal Resistance, Junction to Case	$R_{th(j-c)Q}$	Per IGBT	–	–	0.19	$^\circ\text{C/W}$
Thermal Resistance, Junction to Case	$R_{th(j-c)D}$	Per FWDi	–	–	0.35	$^\circ\text{C/W}$
Thermal Resistance, Junction to Case	$R_{th(j-c)}$	Clamp Diode Part	–	–	0.35	$^\circ\text{C/W}$
Contact Thermal Resistance	$R_{th(c-f)}$	Per Module, Thermal Grease Applied	–	0.035	–	$^\circ\text{C/W}$

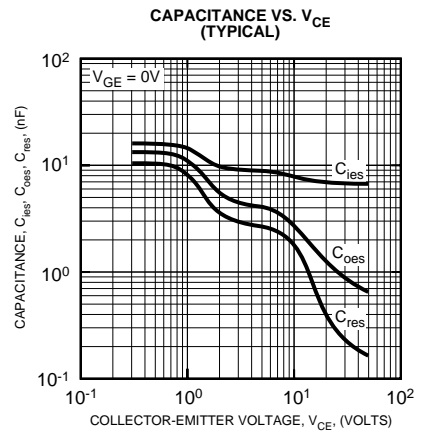
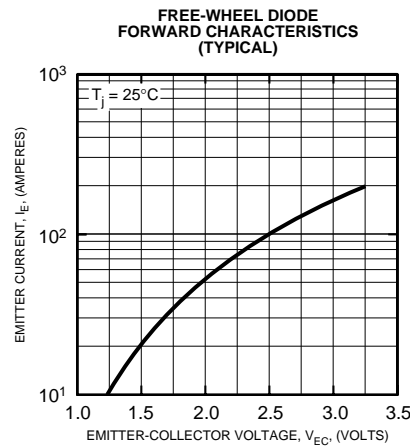
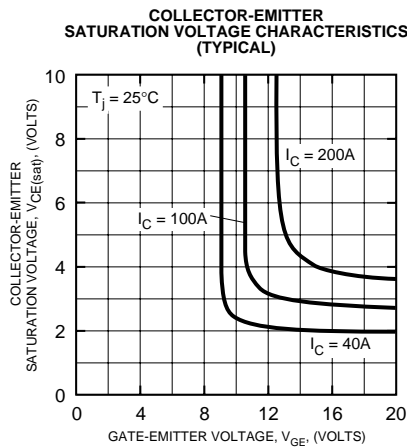
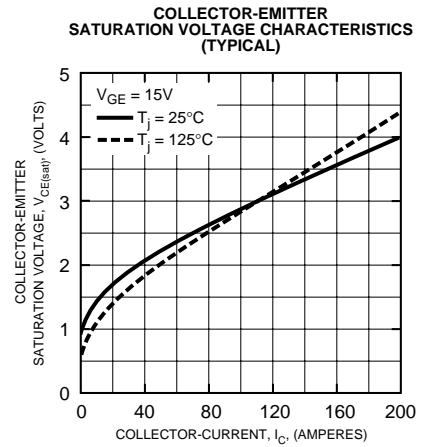
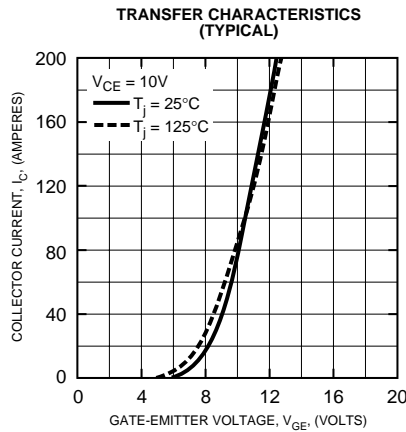
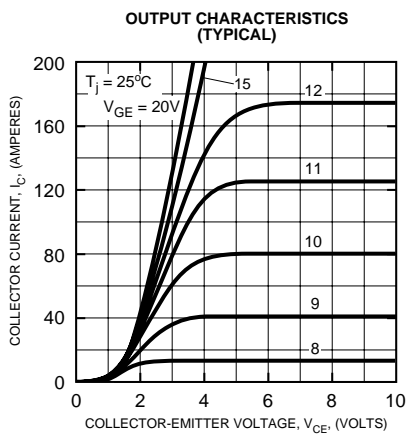

CM100E3U-24H

HIGH POWER SWITCHING USE
INSULATED TYPE

HALF-BRIDGE SWITCHING CHARACTERISTICS (TYPICAL)

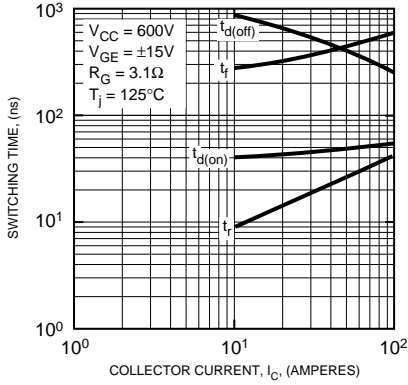

REVERSE RECOVERY CHARACTERISTICS (TYPICAL)

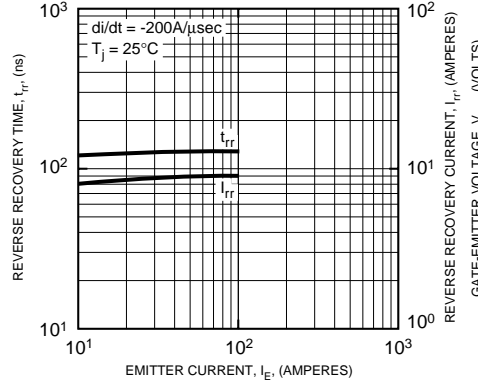

GATE CHARGE, V_{GE}

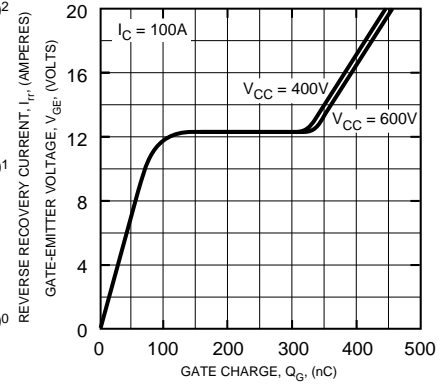

TRANSIENT THERMAL IMPEDANCE CHARACTERISTICS (IGBT)

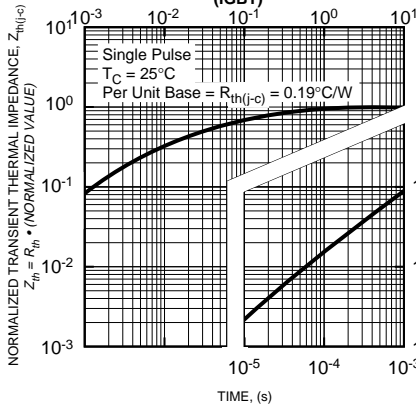

TRANSIENT THERMAL IMPEDANCE CHARACTERISTICS (FWDi)

