

# Technische Information / Technical Information

IGBT-Module  
IGBT-Modules

## FP15R12KE3G

eupec

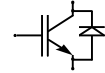

Vorläufige Daten  
Preliminary data

### Elektrische Eigenschaften / Electrical properties

#### Höchstzulässige Werte / Maximum rated values

##### Diode Gleichrichter/ Diode Rectifier

Periodische Rückw. Spitzenspernung repetitive peak reverse voltage		$V_{RRM}$	1600	V
Gleichrichter Ausgang Grenzeffektivstrom maximum RMS current at Rectifier output		$I_{RMSmax}$	60	A
Dauergleichstrom DC forward current	$T_C = 80^\circ C$	$I_d$	15	A
Stoßstrom Grenzwert surge forward current	$t_p = 10 \text{ ms}, T_{vj} = 25^\circ C$ $t_p = 10 \text{ ms}, T_{vj} = 150^\circ C$	$I_{FSM}$	315 260	A A
Grenzlastintegral $I^2t$ - value	$t_p = 10 \text{ ms}, T_{vj} = 25^\circ C$ $t_p = 10 \text{ ms}, T_{vj} = 150^\circ C$	$I^2t$	500 340	$A^2s$ $A^2s$

##### Transistor Wechselrichter/ Transistor Inverter

Kollektor-Emitter-Spernung collector-emitter voltage		$V_{CES}$	1200	V
Kollektor-Dauergleichstrom DC-collector current	$T_C = 80^\circ C$ $T_C = 25^\circ C$	$I_{C,nom.}$ $I_C$	15 25	A A
Periodischer Kollektor Spitzenstrom repetitive peak collector current	$t_p = 1 \text{ ms}, T_C = 80^\circ C$	$I_{CRM}$	30	A
Gesamt-Verlustleistung total power dissipation	$T_C = 25^\circ C$	$P_{tot}$	100	W
Gate-Emitter-Spernung gate-emitter peak voltage		$V_{GES}$	+/- 20V	V

##### Diode Wechselrichter/ Diode Inverter

Dauergleichstrom DC forward current	$T_C = 80^\circ C$	$I_F$	15	A
Periodischer Spitzenstrom repetitive peak forw. current	$t_p = 1 \text{ ms}$	$I_{FRM}$	30	A
Grenzlastintegral $I^2t$ - value	$V_R = 0V, t_p = 10\text{ms}, T_{vj} = 125^\circ C$	$I^2t$	60	$A^2s$

##### Transistor Brems-Chopper/ Transistor Brake-Chopper

Kollektor-Emitter-Spernung collector-emitter voltage		$V_{CES}$	1200	V
Kollektor-Dauergleichstrom DC-collector current	$T_C = 80^\circ C$ $T_C = 25^\circ C$	$I_{C,nom.}$ $I_C$	10 18	A A
Periodischer Kollektor Spitzenstrom repetitive peak collector current	$t_p = 1 \text{ ms}, T_C = 80^\circ C$	$I_{CRM}$	20	A
Gesamt-Verlustleistung total power dissipation	$T_C = 25^\circ C$	$P_{tot}$	80	W
Gate-Emitter-Spernung gate-emitter peak voltage		$V_{GES}$	+/- 20V	V

##### Diode Brems-Chopper/ Diode Brake-Chopper

Dauergleichstrom DC forward current	$T_C = 80^\circ C$	$I_F$	10	A
Periodischer Spitzenstrom repetitive peak forw. current	$t_p = 1 \text{ ms}$	$I_{FRM}$	20	A

prepared by: Andreas Schulz	date of publication:10.08.2001
approved by: Robert Severin	revision: 1

# Technische Information / Technical Information

IGBT-Module  
IGBT-Modules

## FP15R12KE3G

eupec

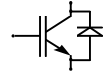

### Vorläufige Daten Preliminary data

#### Modul Isolation/ Module Isolation

Isolations-Prüfspannung insulation test voltage	RMS, f = 50 Hz, t = 1 min. NTC connected to Baseplate	$V_{ISOL}$	2,5	kV
--	--	------------	-----	----

### Elektrische Eigenschaften / Electrical properties

#### Charakteristische Werte / Characteristic values

##### Diode Gleichrichter/ Diode Rectifier

			min.	typ.	max.	
Durchlaßspannung forward voltage	$T_{vj} = 150^{\circ}\text{C}$ , $I_F = 15\text{ A}$	$V_F$	-	0,95	-	V
Schleusenspannung threshold voltage	$T_{vj} = 150^{\circ}\text{C}$	$V_{(TO)}$	-	-	0,8	V
Ersatzwiderstand slope resistance	$T_{vj} = 150^{\circ}\text{C}$	$r_T$	-	-	10,5	m $\Omega$
Sperrstrom reverse current	$T_{vj} = 150^{\circ}\text{C}$ , $V_R = 1600\text{ V}$	$I_R$	-	2	-	mA
Modul Leitungswiderstand, Anschlüsse-Chip lead resistance, terminals-chip	$T_C = 25^{\circ}\text{C}$	$R_{AA+CC}$	-	5	-	m $\Omega$

##### Transistor Wechselrichter/ Transistor Inverter

			min.	typ.	max.	
Kollektor-Emitter Sättigungsspannung collector-emitter saturation voltage	$V_{GE} = 15\text{V}$ , $T_{vj} = 25^{\circ}\text{C}$ , $I_C = 15\text{ A}$	$V_{CE\text{ sat}}$	-	1,7	2,2	V
	$V_{GE} = 15\text{V}$ , $T_{vj} = 125^{\circ}\text{C}$ , $I_C = 15\text{ A}$		-	2	-	V
Gate-Schwellenspannung gate threshold voltage	$V_{CE} = V_{GE}$ , $T_{vj} = 25^{\circ}\text{C}$ , $I_C = 0,5\text{ mA}$	$V_{GE(TO)}$	5,0	5,8	6,5	V
Eingangskapazität input capacitance	f = 1MHz, $T_{vj} = 25^{\circ}\text{C}$ $V_{CE} = 25\text{ V}$ , $V_{GE} = 0\text{ V}$	$C_{ies}$	-	1,1	-	nF
Kollektor-Emitter Reststrom collector-emitter cut off current	$V_{GE} = 0\text{V}$ , $T_{vj} = 25^{\circ}\text{C}$ , $V_{CE} = 1200\text{ V}$	$I_{CES}$	-	-	5	mA
Gate-Emitter Reststrom gate-emitter leakage current	$V_{CE} = 0\text{V}$ , $V_{GE} = 20\text{V}$ , $T_{vj} = 25^{\circ}\text{C}$	$I_{GES}$	-	-	400	nA
Einschaltverzögerungszeit (ind. Last) turn on delay time (inductive load)	$I_C = I_{Nenn}$ , $V_{CC} = 600\text{ V}$	$t_{d,on}$	-	85	-	ns
	$V_{GE} = \pm 15\text{V}$ , $T_{vj} = 25^{\circ}\text{C}$ , $R_G = 75\text{ Ohm}$					
	$V_{GE} = \pm 15\text{V}$ , $T_{vj} = 125^{\circ}\text{C}$ , $R_G = 75\text{ Ohm}$					
Anstiegszeit (induktive Last) rise time (inductive load)	$I_C = I_{Nenn}$ , $V_{CC} = 600\text{ V}$	$t_r$	-	30	-	ns
	$V_{GE} = \pm 15\text{V}$ , $T_{vj} = 25^{\circ}\text{C}$ , $R_G = 75\text{ Ohm}$					
	$V_{GE} = \pm 15\text{V}$ , $T_{vj} = 125^{\circ}\text{C}$ , $R_G = 75\text{ Ohm}$					
Abschaltverzögerungszeit (ind. Last) turn off delay time (inductive load)	$I_C = I_{Nenn}$ , $V_{CC} = 600\text{ V}$	$t_{d,off}$	-	420	-	ns
	$V_{GE} = \pm 15\text{V}$ , $T_{vj} = 25^{\circ}\text{C}$ , $R_G = 75\text{ Ohm}$					
	$V_{GE} = \pm 15\text{V}$ , $T_{vj} = 125^{\circ}\text{C}$ , $R_G = 75\text{ Ohm}$					
Fallzeit (induktive Last) fall time (inductive load)	$I_C = I_{Nenn}$ , $V_{CC} = 600\text{ V}$	$t_f$	-	65	-	ns
	$V_{GE} = \pm 15\text{V}$ , $T_{vj} = 25^{\circ}\text{C}$ , $R_G = 75\text{ Ohm}$					
	$V_{GE} = \pm 15\text{V}$ , $T_{vj} = 125^{\circ}\text{C}$ , $R_G = 75\text{ Ohm}$					
Einschaltverlustenergie pro Puls turn-on energy loss per pulse	$I_C = I_{Nenn}$ , $V_{CC} = 600\text{ V}$ $V_{GE} = \pm 15\text{V}$ , $T_{vj} = 125^{\circ}\text{C}$ , $R_G = 75\text{ Ohm}$ $L_S = 45\text{ nH}$	$E_{on}$	-	2,1	-	mWs
Abschaltverlustenergie pro Puls turn-off energy loss per pulse	$I_C = I_{Nenn}$ , $V_{CC} = 600\text{ V}$ $V_{GE} = \pm 15\text{V}$ , $T_{vj} = 125^{\circ}\text{C}$ , $R_G = 75\text{ Ohm}$ $L_S = 45\text{ nH}$	$E_{off}$	-	1,5	-	mWs
Kurzschlußverhalten SC Data	$t_P \leq 10\mu\text{s}$ , $V_{GE} \leq 15\text{V}$ , $R_G = 75\text{ Ohm}$ $T_{vj} \leq 125^{\circ}\text{C}$ , $V_{CC} = 720\text{ V}$	$I_{SC}$	-	60	-	A

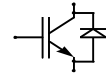

**Vorläufige Daten**  
**Preliminary data**

**Elektrische Eigenschaften / Electrical properties**

**Charakteristische Werte / Characteristic values**

		min.	typ.	max.			
Modulinduktivität stray inductance module		$L_{GCE}$	-	-	100	nH	
Modul Leitungswiderstand, Anschlüsse-Chip lead resistance, terminals-chip	$T_C = 25^\circ C$	$R_{CC'+EE'}$	-	7	-	m $\Omega$	
<b>Diode Wechselrichter/ Diode Inverter</b>				<b>min.</b>	<b>typ.</b>	<b>max.</b>	
Durchlaßspannung forward voltage	$V_{GE} = 0V, T_{vj} = 25^\circ C, I_F = 15 A$ $V_{GE} = 0V, T_{vj} = 125^\circ C, I_F = 15 A$	$V_F$	-	1,65	2,2	V	
Rückstromspitze peak reverse recovery current	$I_F = I_{Nenn}, -di_F/dt = 400 A/\mu s$ $V_{GE} = -10V, T_{vj} = 25^\circ C, V_R = 600 V$ $V_{GE} = -10V, T_{vj} = 125^\circ C, V_R = 600 V$	$I_{RM}$	-	16	-	A	
Sperrverzögerungsladung recovered charge	$I_F = I_{Nenn}, -di_F/dt = 400 A/\mu s$ $V_{GE} = -10V, T_{vj} = 25^\circ C, V_R = 600 V$ $V_{GE} = -10V, T_{vj} = 125^\circ C, V_R = 600 V$	$Q_r$	-	1,8	-	$\mu As$	
Abschaltenergie pro Puls reverse recovery energy	$I_F = I_{Nenn}, -di_F/dt = 400 A/\mu s$ $V_{GE} = -10V, T_{vj} = 25^\circ C, V_R = 600 V$ $V_{GE} = -10V, T_{vj} = 125^\circ C, V_R = 600 V$	$E_{RO}$	-	0,55	-	mWs	
<b>Transistor Brems-Chopper/ Transistor Brake-Chopper</b>				<b>min.</b>	<b>typ.</b>	<b>max.</b>	
Kollektor-Emitter Sättigungsspannung collector-emitter saturation voltage	$V_{GE} = 15V, T_{vj} = 25^\circ C, I_C = 10 A$ $V_{GE} = 15V, T_{vj} = 125^\circ C, I_C = 10 A$	$V_{CE sat}$	-	1,85	2,5	V	
Gate-Schwellenspannung gate threshold voltage	$V_{CE} = V_{GE}, T_{vj} = 25^\circ C, I_C = 0,3 mA$	$V_{GE(To)}$	5,0	5,8	6,5	V	
Eingangskapazität input capacitance	$f = 1MHz, T_{vj} = 25^\circ C$ $V_{CE} = 25 V, V_{GE} = 0 V$	$C_{ies}$	-	0,6	-	nF	
Kollektor-Emitter Reststrom collector-emitter cut off current	$V_{GE} = 0V, T_{vj} = 25^\circ C, V_{CE} = 1200 V$	$I_{CES}$	-	5,0	-	mA	
Gate-Emitter Reststrom gate-emitter leakage current	$V_{CE} = 0V, V_{GE} = 20V, T_{vj} = 25^\circ C$	$I_{GES}$	-	-	400	nA	
Schaltverluste und -bedingungen Switching losses and conditions	siehe Wechselrichter in Dbl FP10R12KE3 see inverter in datasheet FP10R12KE3						
<b>Diode Brems-Chopper/ Diode Brake-Chopper</b>				<b>min.</b>	<b>typ.</b>	<b>max.</b>	
Durchlaßspannung forward voltage	$T_{vj} = 25^\circ C, I_F = 10 A$ $T_{vj} = 125^\circ C, I_F = 10 A$	$V_F$	-	1,8	2,5	V	
Schaltverluste und -bedingungen Switching losses and conditions	siehe Wechselrichter in Dbl FB10R12KE3 see inverter in datasheet FB10R12KE3						
<b>NTC-Widerstand/ NTC-Thermistor</b>				<b>min.</b>	<b>typ.</b>	<b>max.</b>	
Nennwiderstand rated resistance	$T_C = 25^\circ C$	$R_{25}$	-	5	-	k $\Omega$	
Abweichung von $R_{100}$ deviation of $R_{100}$	$T_C = 100^\circ C, R_{100} = 493 \Omega$	$\Delta R/R$	-5		5	%	
Verlustleistung power dissipation	$T_C = 25^\circ C$	$P_{25}$			20	mW	
B-Wert B-value	$R_2 = R_1 \exp [B(1/T_2 - 1/T_1)]$	$B_{25/50}$		3375		K	

# Technische Information / Technical Information

IGBT-Module  
IGBT-Modules

## FP15R12KE3G

eupec

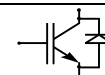

### Vorläufige Daten Preliminary data

#### Thermische Eigenschaften / Thermal properties

		min.	typ.	max.		
Innerer Wärmewiderstand thermal resistance, junction to case	Gleicher. Diode/ Rectif. Diode	$R_{thJC}$	-	-	1	K/W
	Trans. Wechr./ Trans. Inverter		-	-	1,2	K/W
	Diode Wechr./ Diode Inverter		-	-	1,5	K/W
	Trans. Bremse/ Trans. Brake		-	-	1,5	K/W
	Diode Bremse/ Diode Brake		-	-	2,3	K/W
Übergangs-Wärmewiderstand thermal resistance, case to heatsink	Gleicher. Diode/ Rectif. Diode	$R_{thCK}$	-	0,08	-	K/W
	Trans. Wechr./ Trans. Inverter	$\lambda_{paste}=1W/m^2K$	-	0,04	-	K/W
	Diode Wechr./ Diode Inverter	$\lambda_{grease}=1W/m^2K$	-	0,08	-	K/W
Höchstzulässige Sperrschichttemperatur maximum junction temperature		$T_{vj}$	-	-	150	°C
Betriebstemperatur operation temperature		$T_{op}$	-40	-	125	°C
Lagertemperatur storage temperature		$T_{stg}$	-40	-	125	°C

#### Mechanische Eigenschaften / Mechanical properties

Innere Isolation internal insulation				$Al_2O_3$	
CTI comperative tracking index				225	
Anzugsdrehmoment f. mech. Befestigung mounting torque		M		3 $\pm 10\%$	Nm
Gewicht weight		G		180	g

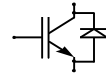

Vorläufige Daten  
Preliminary data

Ausgangskennlinienfeld Wechselr. (typisch)  
Output characteristic Inverter (typical)

$I_C = f(V_{CE})$   
 $V_{GE} = 15\text{ V}$

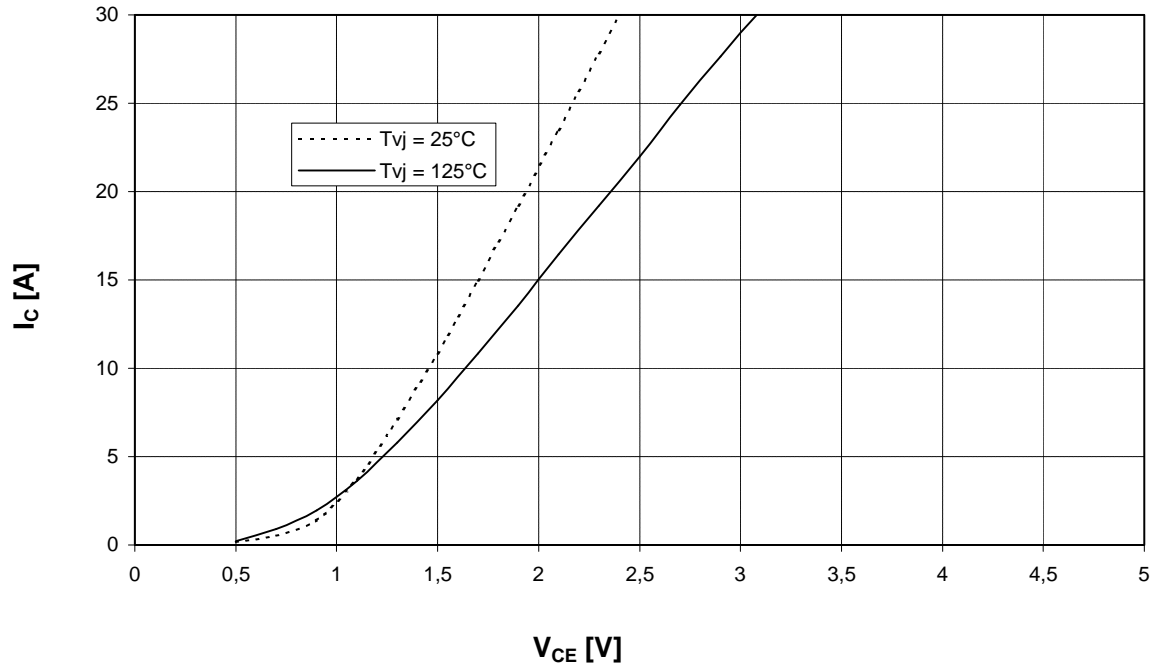

Ausgangskennlinienfeld Wechselr. (typisch)  
Output characteristic Inverter (typical)

$I_C = f(V_{CE})$   
 $T_{vj} = 125^\circ\text{C}$

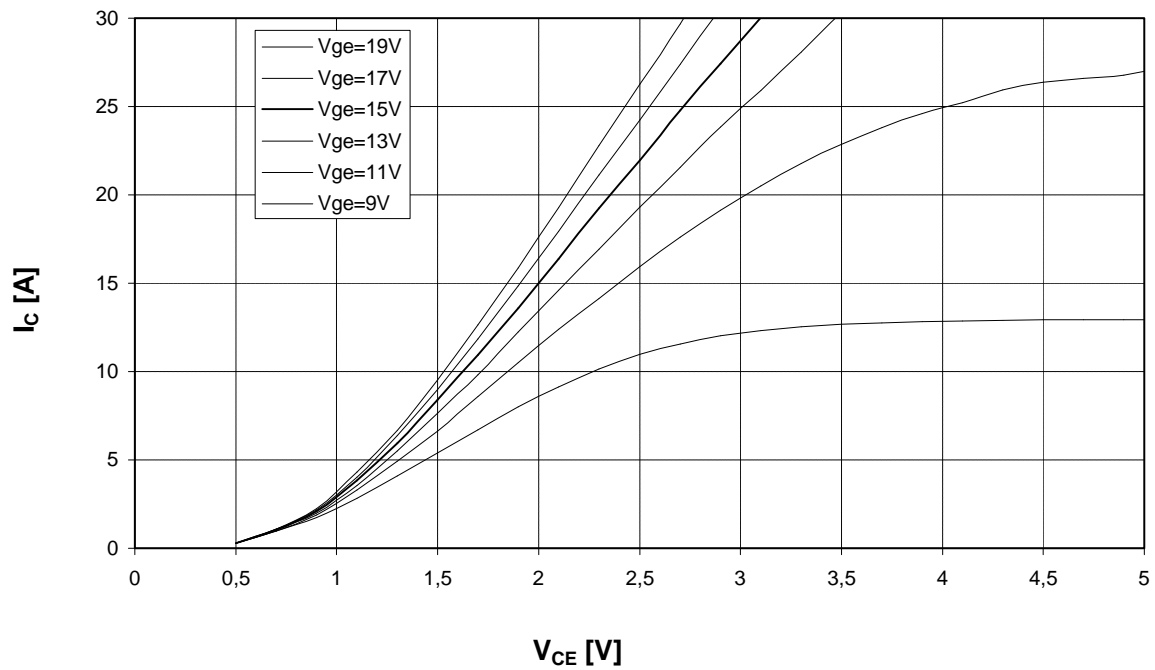

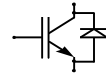

Vorläufige Daten  
Preliminary data

Übertragungscharakteristik Wechselr. (typisch)  
Transfer characteristic Inverter (typical)

$I_C = f(V_{GE})$   
 $V_{CE} = 20\text{ V}$

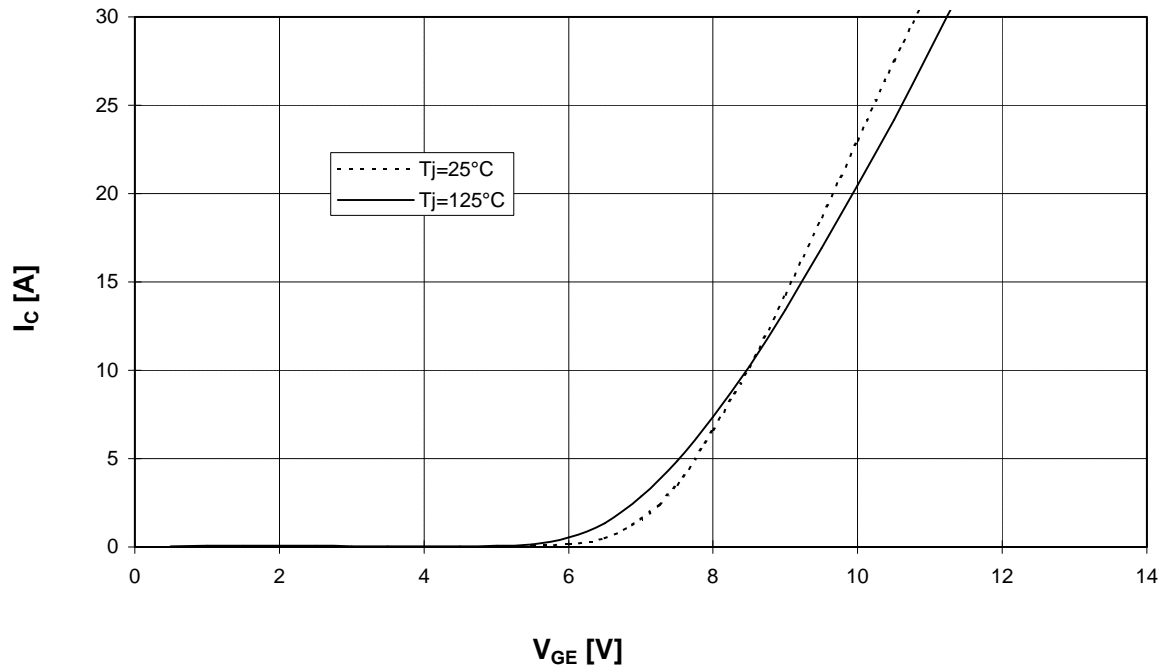

Durchlaßkennlinie der Freilaufdiode Wechselr. (typisch)  
Forward characteristic of FWD Inverter (typical)

$I_F = f(V_F)$

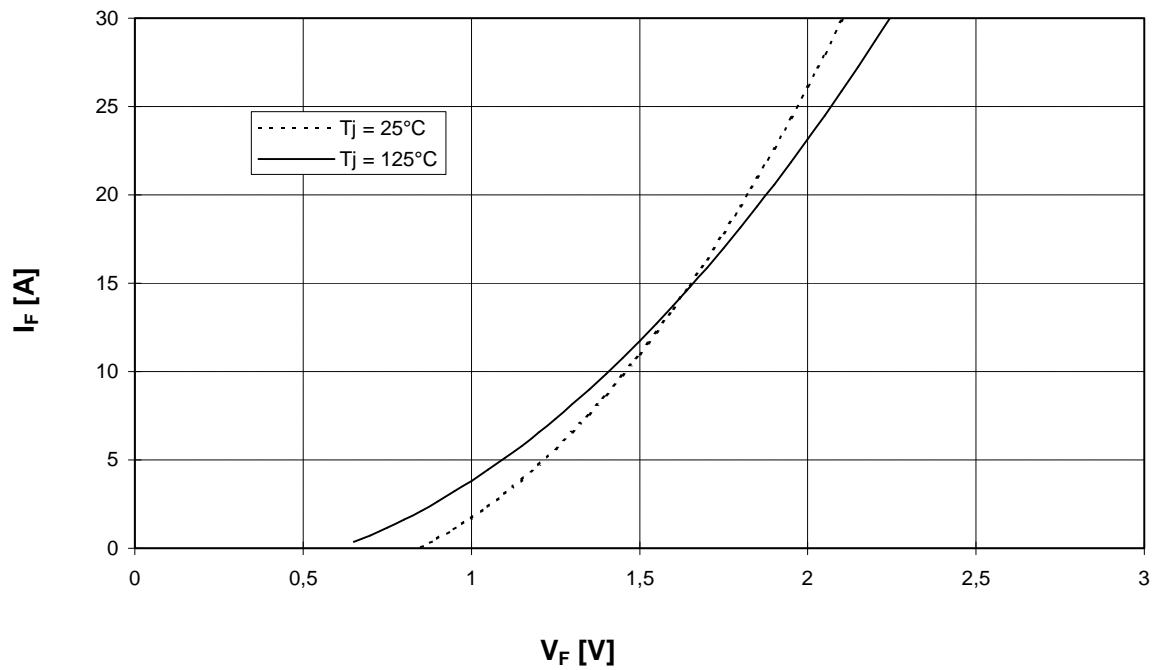

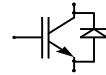

Vorläufige Daten

Preliminary data

Schaltverluste Wechselr. (typisch)  $E_{on} = f(I_C), E_{off} = f(I_C), E_{rec} = f(I_C)$   $V_{CC} = 600\text{ V}$   
 Switching losses Inverter (typical)  $T_j = 125^\circ\text{C}, V_{GE} = \pm 15\text{ V}, R_{Gon} = R_{Goff} = 75\text{ Ohm}$

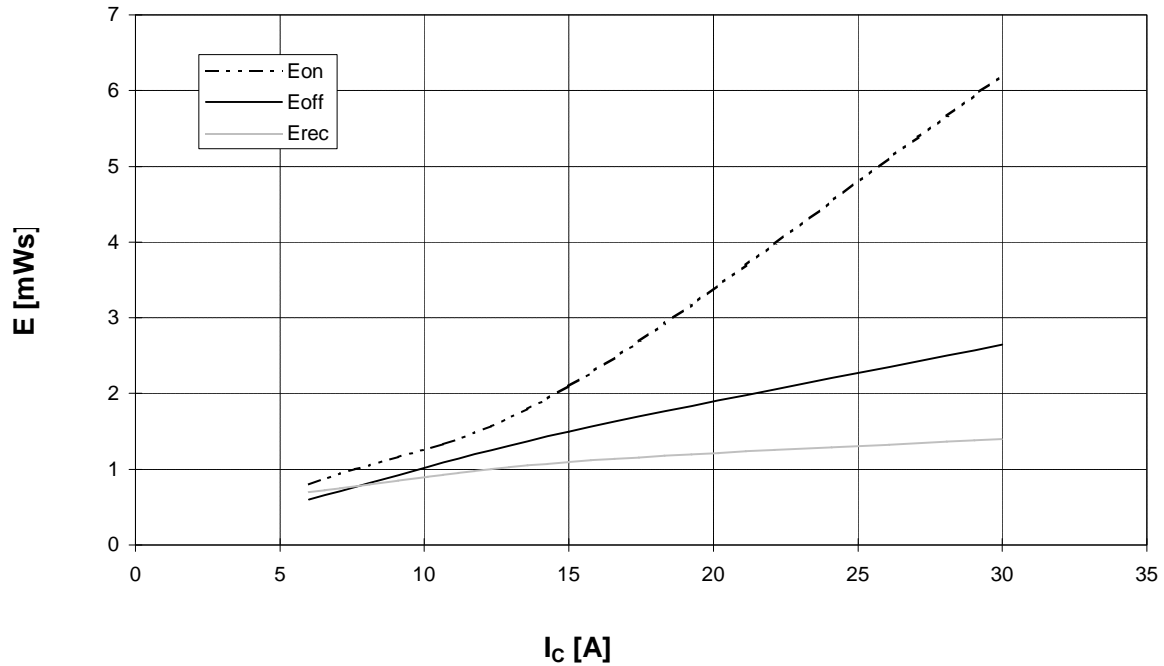

Schaltverluste Wechselr. (typisch)  $E_{on} = f(R_G), E_{off} = f(R_G), E_{rec} = f(R_G)$   
 Switching losses Inverter (typical)  $T_j = 125^\circ\text{C}, V_{GE} = \pm 15\text{ V}, I_C = I_{nenn}, V_{CC} = 600\text{ V}$

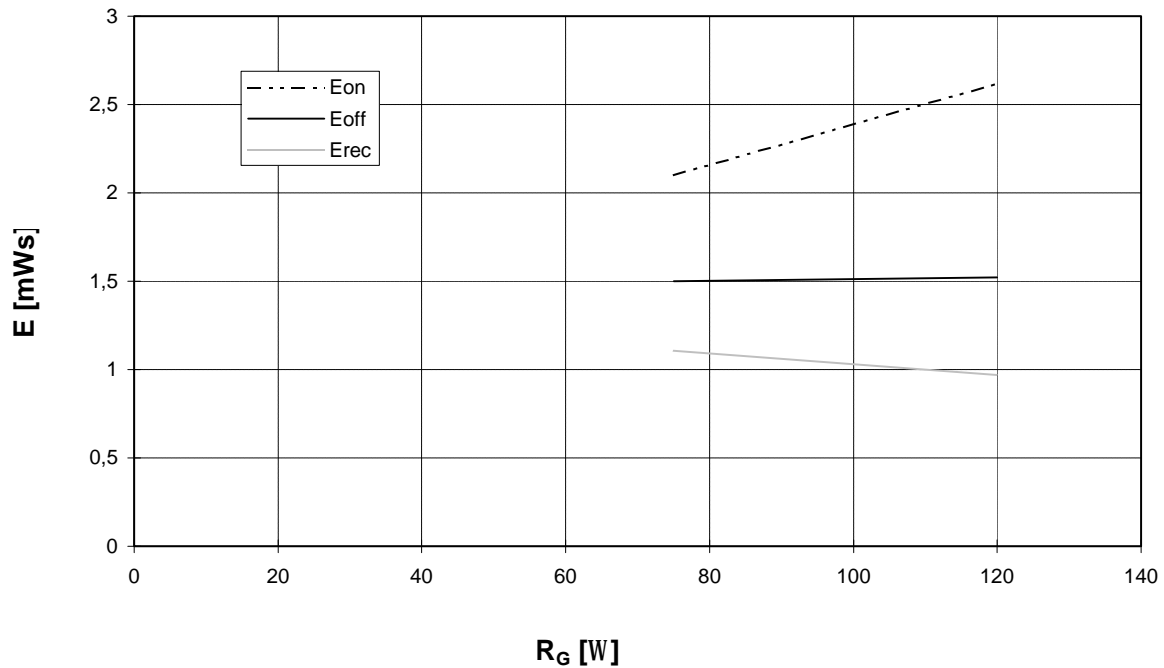

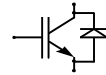

Vorläufige Daten  
Preliminary data

Transienter Wärmewiderstand Wechsler.  
Transient thermal impedance Inverter

$$Z_{thJC} = f(t)$$

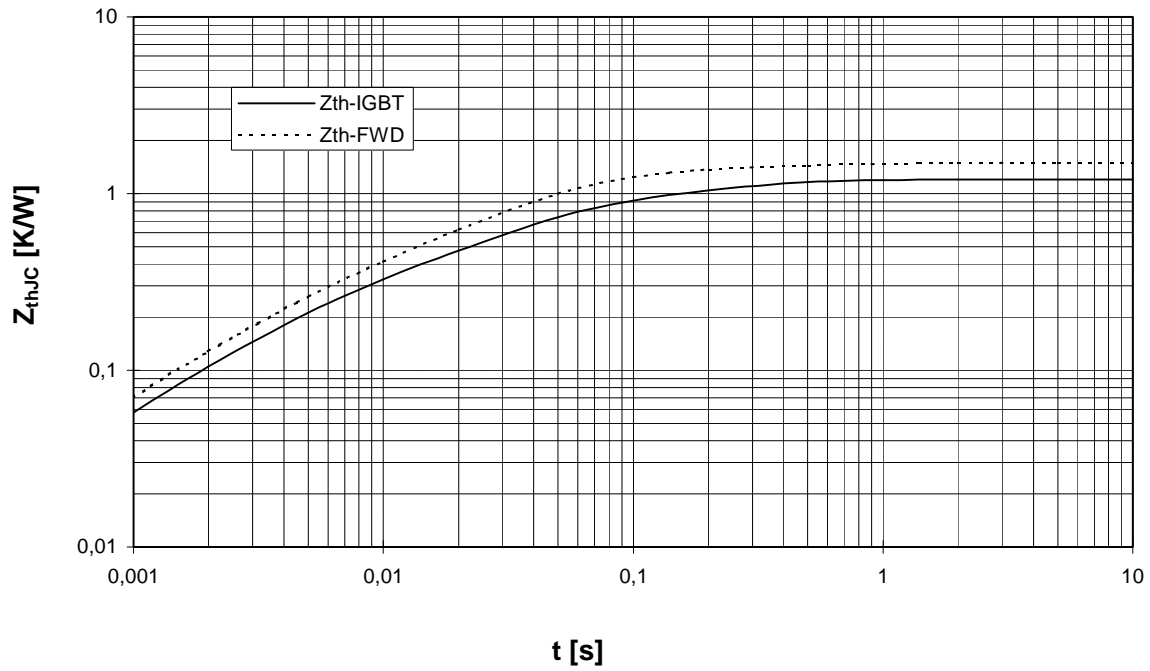

Sicherer Arbeitsbereich Wechsler. (RBSOA)

$$I_C = f(V_{CE})$$

Reverse bias safe operating area Inverter (RBSOA)  $T_{vj} = 125^\circ\text{C}, V_{GE} = \pm 15\text{V}$

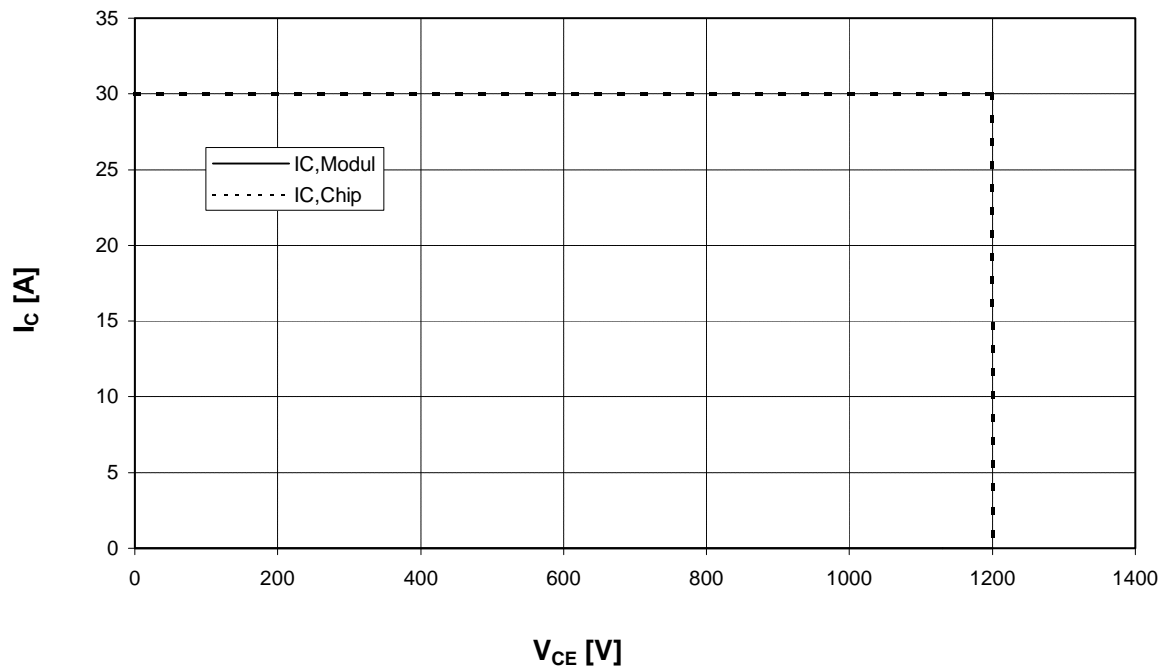



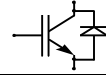

Vorläufige Daten

Preliminary data

Ausgangskennlinienfeld Brems-Chopper-IGBT (typisch)

Output characteristic brake-chopper-IGBT (typical)

$I_C = f(V_{CE})$

$V_{GE} = 15\text{ V}$

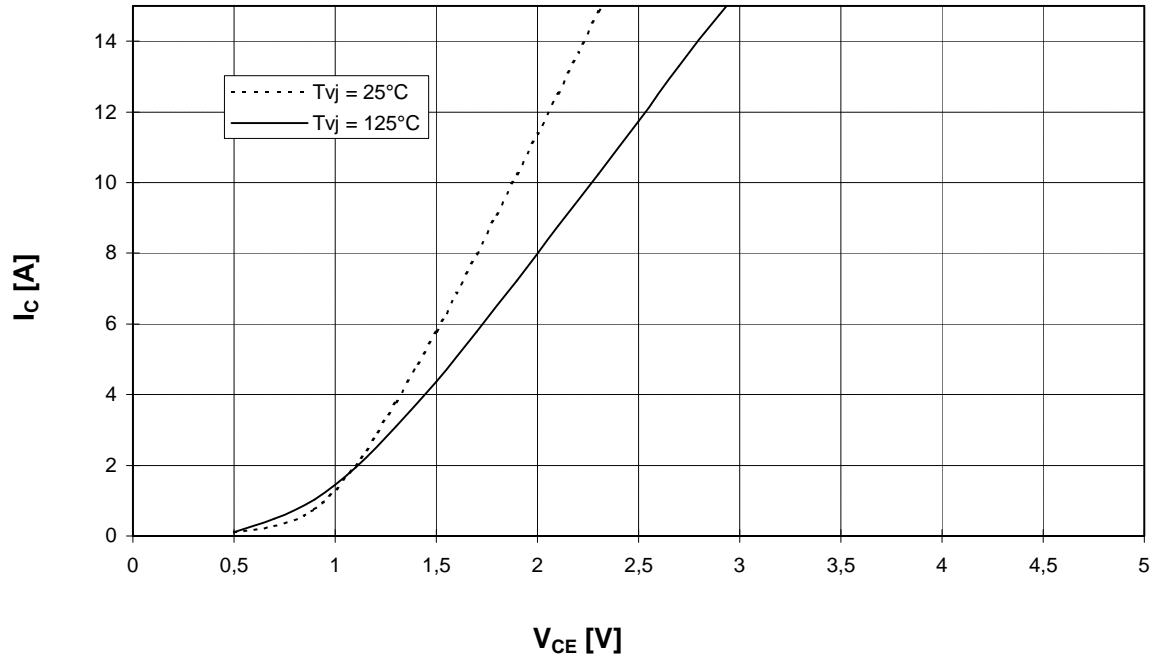

Durchlaßkennlinie der Brems-Chopper-Diode (typisch)  $I_F = f(V_F)$

Forward characteristic of brake-chopper-FWD (typical)

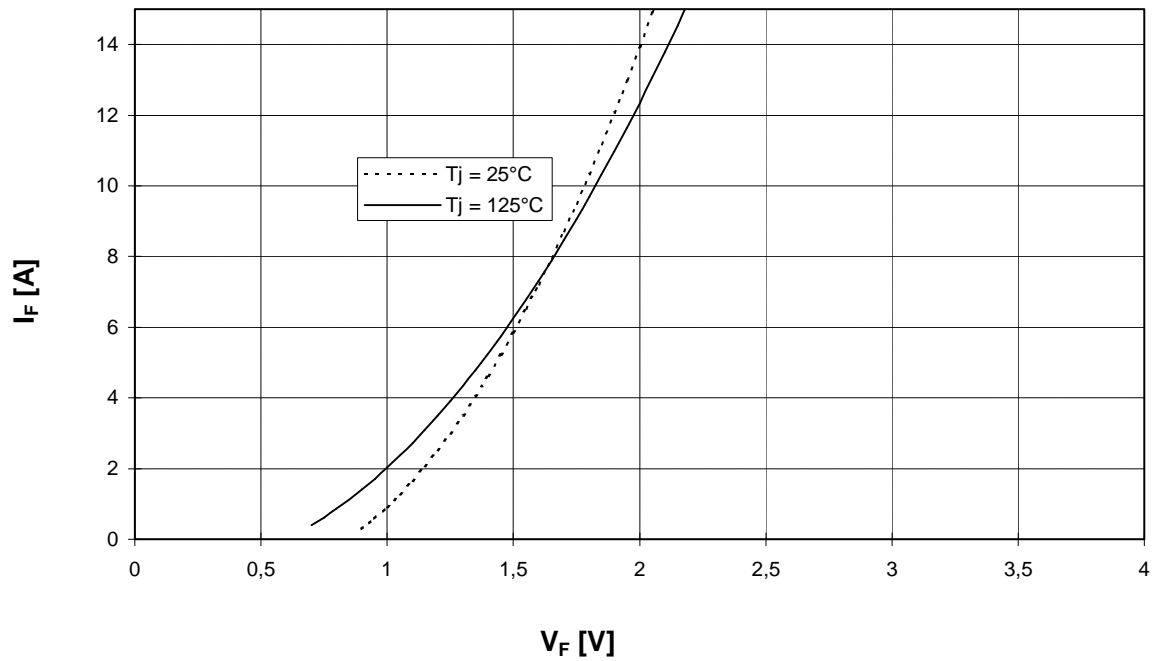

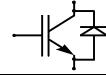

Vorläufige Daten  
Preliminary data

Durchlaßkennlinie der Gleichrichterdiode (typisch)  
Forward characteristic of Rectifier Diode (typical)

$$I_F = f(V_F)$$

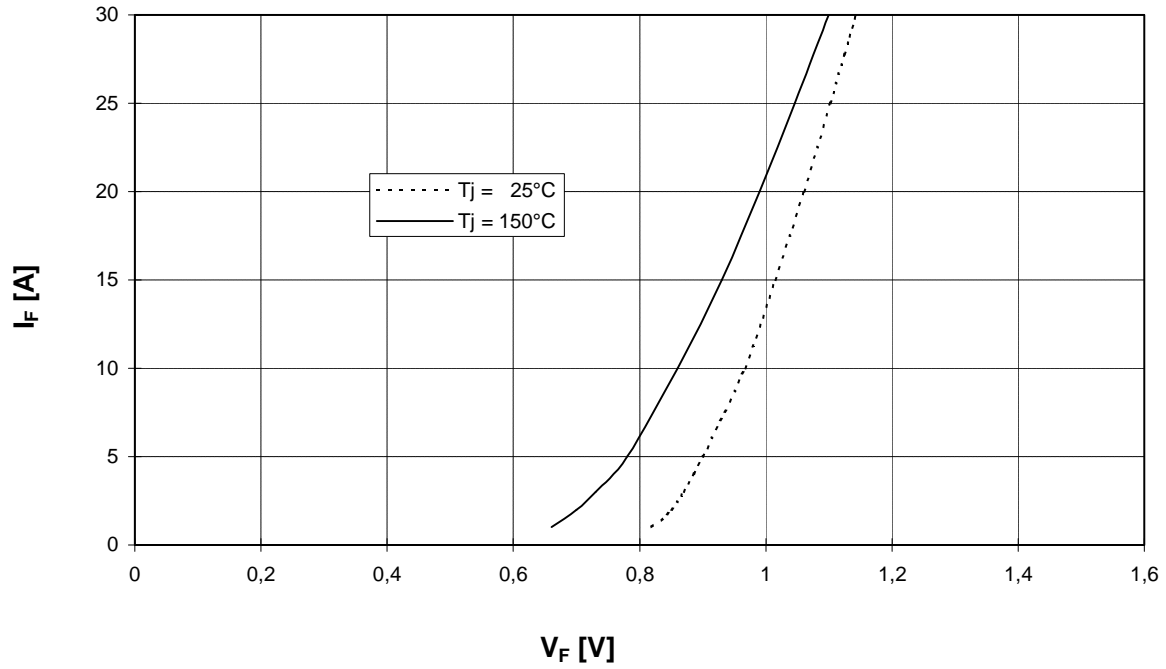

NTC- Temperaturkennlinie (typisch)

$$R = f(T)$$

NTC- temperature characteristic (typical)

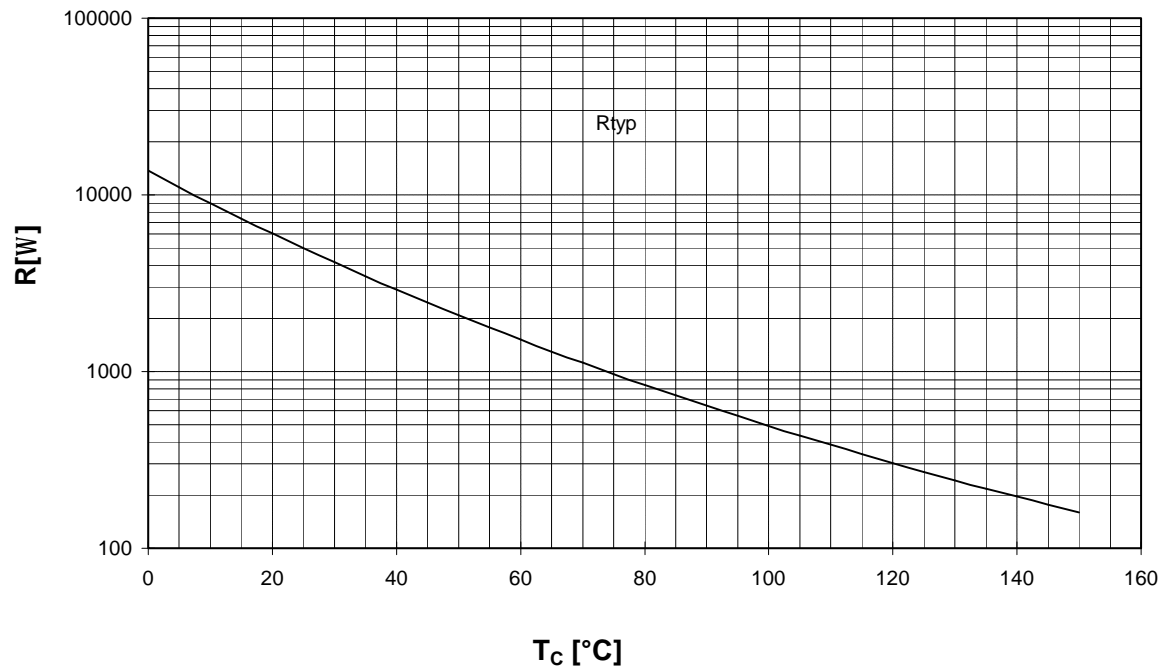

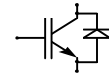

Vorläufige Daten  
Preliminary data

Schaltplan/ Circuit diagram

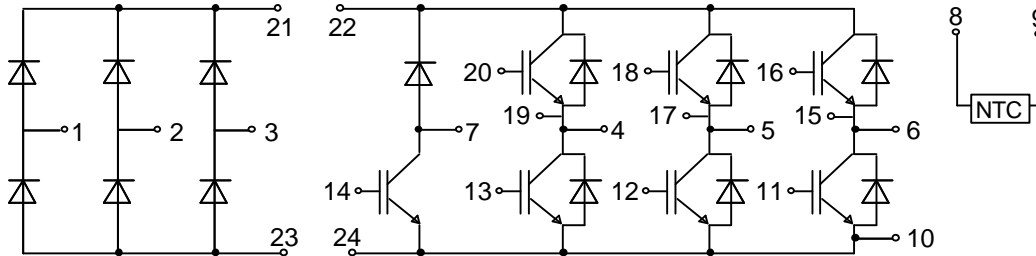

Gehäuseabmessungen/ Package outlines

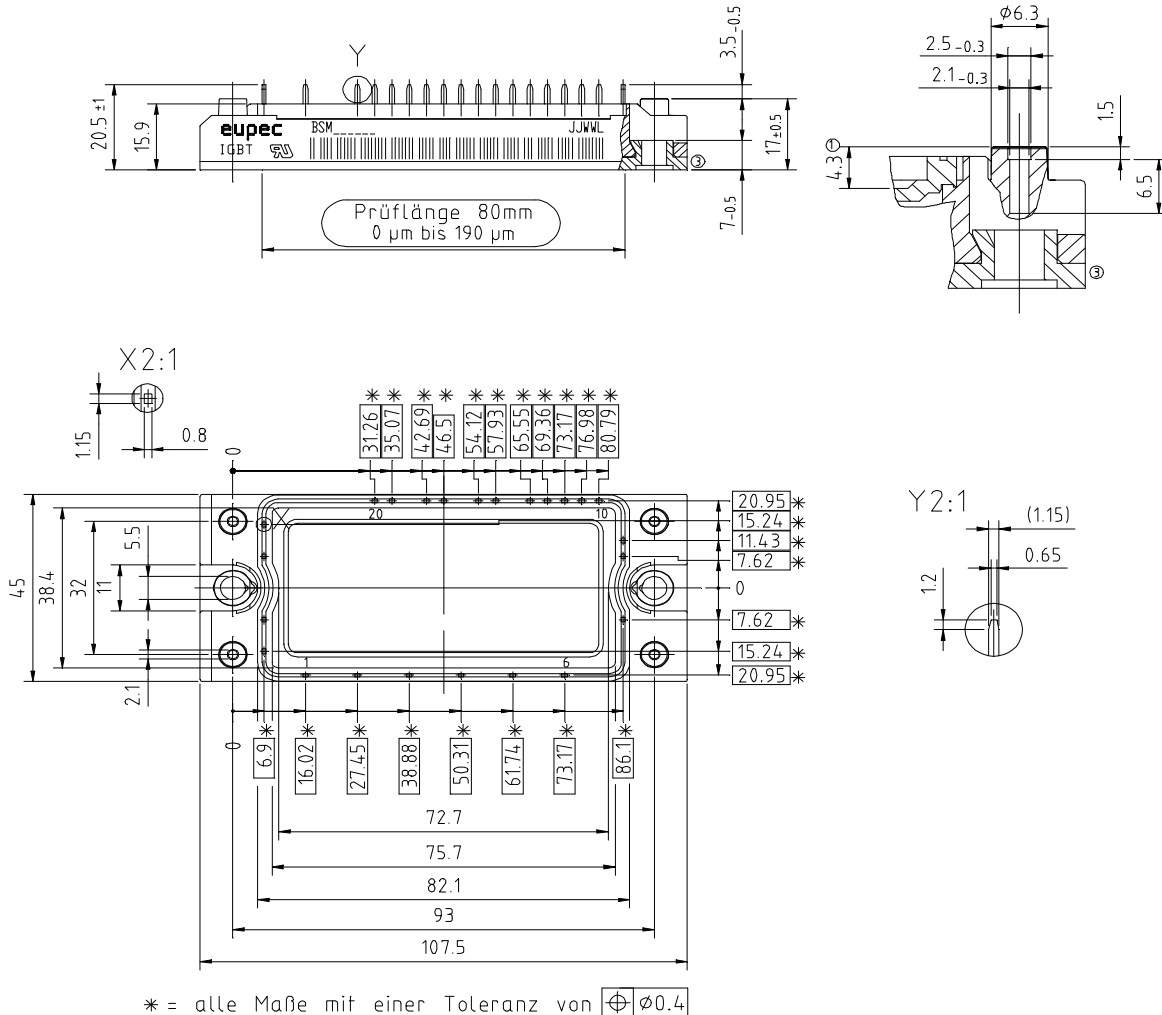

Mit dieser technischen Information werden Halbleiterbauelemente spezifiziert, jedoch keine Eigenschaften zugesichert. Sie gilt in Verbindung mit den zugehörigen Technischen Erläuterungen.

This technical information specifies semiconductor devices but promises no characteristics. It is valid in combination with the belonging technical notes.

## **Terms & Conditions of Usage**

### **Attention**

The present product data is exclusively subscribed to technically experienced staff. This Data Sheet is describing the specification of the products for which a warranty is granted exclusively pursuant the terms and conditions of the supply agreement. There will be no guarantee of any kind for the product and its specifications. Changes to the Data Sheet are reserved.

You and your technical departments will have to evaluate the suitability of the product for the intended application and the completeness of the product data with respect to such application. Should you require product information in excess of the data given in the Data Sheet, please contact your local Sales Office via "[www.eupec.com / sales & contact](http://www.eupec.com / sales & contact)".

### **Warning**

Due to technical requirements the products may contain dangerous substances. For information on the types in question please contact your local Sales Office via "[www.eupec.com / sales & contact](http://www.eupec.com / sales & contact)".