

STANDARD RECOVERY DIODES

MAGN-A-pak™ Power Modules

Features

- High voltage
- Electrically isolated base plate
- 3000 V_{RMS} isolating voltage
- Industrial standard package
- Simplified mechanical designs, rapid assembly
- High surge capability
- Large creepage distances
- UL E78996 approved 

250A
270A
320A

Description

This new IRK series of MAGN-A-paks uses high voltage power diodes in two basic configurations. The semiconductors are electrically isolated from the metal base, allowing common heatsinks and compact assemblies to be built. They can be interconnected to form single phase or three phase bridges and the single diode module can be used in conjunction with the thyristor modules as a freewheel diode. These modules are intended for general purpose applications such as battery chargers, welders and plating equipment and where high voltage and high current are required (motor drives, etc.).

Major Ratings and Characteristics

| Parameters | IRK.250.. | IRK.270.. | IRK.320.. | Units |
|---------------|------------|------------|------------|--------------------|
| $I_{F(AV)}$ | 250 | 270 | 320 | A |
| @ T_C | 100 | 100 | 100 | °C |
| $I_{F(RMS)}$ | 393 | 424 | 502 | A |
| I_{FSM} | | | | |
| @ 50Hz | 7015 | 8920 | 10110 | A |
| @ 60Hz | 7345 | 9430 | 10580 | A |
| I^2t | | | | |
| @ 50Hz | 246 | 398 | 511 | KA ² s |
| @ 60Hz | 225 | 363 | 466 | KA ² s |
| $I^2\sqrt{t}$ | 2460 | 3980 | 5110 | KA ² √s |
| V_{RRM} | Up to 2000 | Up to 3000 | Up to 2000 | V |
| T_J | -40 to 150 | | | °C |

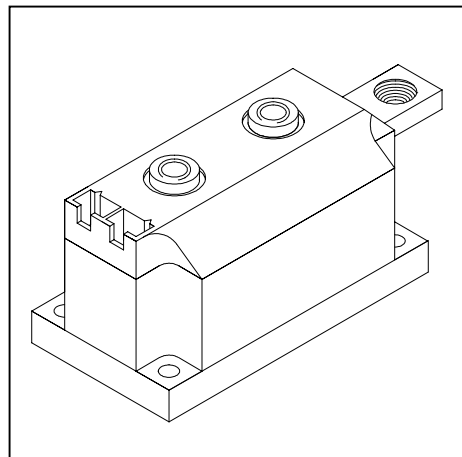

ELECTRICAL SPECIFICATIONS

Voltage Ratings

| Type number | Voltage Code | V_{RRM} , Maximum repetitive peak reverse voltage V | V_{RSM} , Maximum non-repetitive peak reverse voltage V | I_{RRM} Max @ 150°C mA |
|----------------------------------|--------------|--|--|-----------------------------|
| IRK.250- IRK.270- IRK.320- | 04 | 400 | 500 | 50 |
| | 08 | 800 | 900 | |
| | 12 | 1200 | 1300 | |
| | 16 | 1600 | 1700 | |
| IRK.320- | 20 | 2000 | 2100 | 50 |
| | 24 | 2400 | 2500 | |
| | 30 | 3000 | 3100 | |

Forward Conduction

| Parameters | IRK.250 | IRK.270 | IRK.320 | Units | Conditions | | |
|---|---------|---------|---------|--------------------|---|---------------------------|---|
| $I_{F(AV)}$ Maximum average forward current @ Case temperature | 250 | 270 | 320 | A | 180° conduction, half sine wave | | |
| | 100 | 100 | 100 | °C | | | |
| $I_{F(RMS)}$ Maximum RMS forward current | 393 | 424 | 502 | A | as AC switch | | |
| I_{FSM} Maximum peak, one-cycle forward, non-repetitive surge current | 7015 | 8920 | 10110 | A | t = 10ms | No voltage reappplied | Sinusoidal half wave, Initial $T_J = T_{J,max}$ |
| | 7345 | 9340 | 10580 | | t = 8.3ms | | |
| | 5900 | 7500 | 8500 | | t = 10ms | 100% V_{RRM} reappplied | |
| | 6180 | 7850 | 8900 | | t = 8.3ms | | |
| I^2t Maximum I^2t for fusing | 246 | 398 | 511 | KA ² s | t = 10ms | No voltage reappplied | Initial $T_J = T_{J,max}$ |
| | 225 | 363 | 466 | | t = 8.3ms | | |
| | 174 | 281 | 361 | | t = 10ms | 100% V_{RRM} reappplied | |
| | 159 | 257 | 330 | | t = 8.3ms | | |
| $I^2\sqrt{t}$ Maximum $I^2\sqrt{t}$ for fusing | 2460 | 3980 | 5110 | KA ² √s | t = 0.1 to 10ms, no voltage reappplied | | |
| $V_{F(TO)1}$ Low level val. of threshold voltage | 0.79 | 0.74 | 0.69 | V | $(16.7\% \times \pi \times I_{F(AV)} < I < \pi \times I_{F(AV)})$, $T_J = T_{J,max}$. | | |
| $V_{F(TO)2}$ High level val. of threshold voltage | 0.92 | 0.87 | 0.86 | V | $(I > \pi \times I_{F(AV)})$, $T_J = T_{J,max}$. | | |
| r_{T1} Low level forward slope resistance | 0.63 | 0.94 | 0.59 | mΩ | $(16.7\% \times \pi \times I_{F(AV)} < I < \pi \times I_{F(AV)})$, $T_J = T_{J,max}$. | | |
| r_{T2} High level forward slope resistance | 0.49 | 0.81 | 0.44 | mΩ | $(I > \pi \times I_{F(AV)})$, $T_J = T_{J,max}$. | | |
| V_{FM} Maximum forward voltage drop | 1.29 | 1.48 | 1.28 | V | $I_{FM} = \pi \times I_{F(AV)}$, $T_J = T_{J,max}$, 180° conduction Av. power = $V_{F(TO)} \times I_{F(AV)} + r_T \times (I_{F(RMS)})^2$ | | |

Blocking

| Parameter | IRK.250/.270/.320 | Units | Conditions |
|---|-------------------|-------|--|
| I_{RRM} Max. peak reverse leakage current | 50 | mA | $T_J = 150^\circ\text{C}$ |
| V_{INS} RMS isolation voltage | 3000 | V | 50Hz, circuit to base, all terminals shorted, t=1sec |

Thermal and Mechanical Specifications

| Parameter | IRK.250 / .270 / .320 | Units | Conditions |
|---|-----------------------|--------|---|
| T _J Max. junction operating temperature range | -40 to 150 | °C | |
| T _{stg} Max. storage temperature range | -40 to 150 | °C | |
| R _{thJC} Max. thermal resistance, junction to case | 0.16 0.125 0.125 | K/W | Per junction, DC operation |
| R _{thCS} Max. thermal resistance, case to heatsink | 0.035 | K/W | Mounting surface flat, smooth and greased Per module |
| T Mounting torque ±10% MAP to heatsink busbar to MAP | 4 to 6 8 to 10 | Nm | A mounting compound is recommended and the torque should be rechecked after a period of 3 hours to allow for the spread of the compound |
| wt Approximate weight | 800 (30) | g (oz) | |

ΔR Conduction (per Junction)

(The following table shows the increment of thermal resistance R_{thJC} when devices operate at different conduction angles than DC)

| Devices | Sinusoidal conduction @ T _J max. | | | | | Rectangular conduction @ T _J max. | | | | | Units |
|----------|---|-------|-------|-------|-------|--|-------|-------|-------|-------|-------|
| | 180° | 120° | 90° | 60° | 30° | 180° | 120° | 90° | 60° | 30° | |
| IRK.250- | 0.009 | 0.010 | 0.014 | 0.020 | 0.032 | 0.007 | 0.011 | 0.015 | 0.021 | 0.033 | K/W |
| IRK.270- | 0.008 | 0.012 | 0.014 | 0.020 | 0.032 | 0.007 | 0.011 | 0.015 | 0.020 | 0.033 | |
| IRK.320- | 0.008 | 0.010 | 0.013 | 0.020 | 0.032 | 0.007 | 0.011 | 0.015 | 0.020 | 0.033 | |

Ordering Information Table

Device Code

IRK

D

320

-

24

①
②
③
④

- 1 - Module type
- 2 - Circuit configuration
- 3 - Current rating: I_{F(AV)} x 10 rounded
- 4 - Voltage code: Code x 100 = V_{RRM} (see Voltage Rating Table)

Outline Table

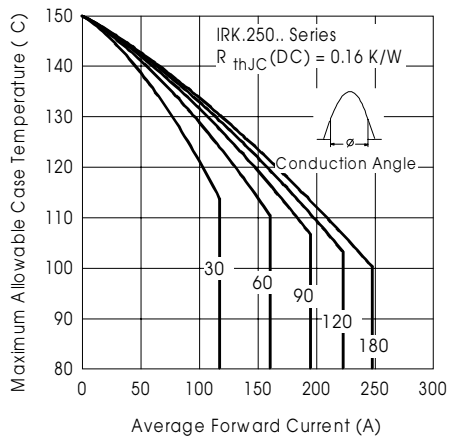
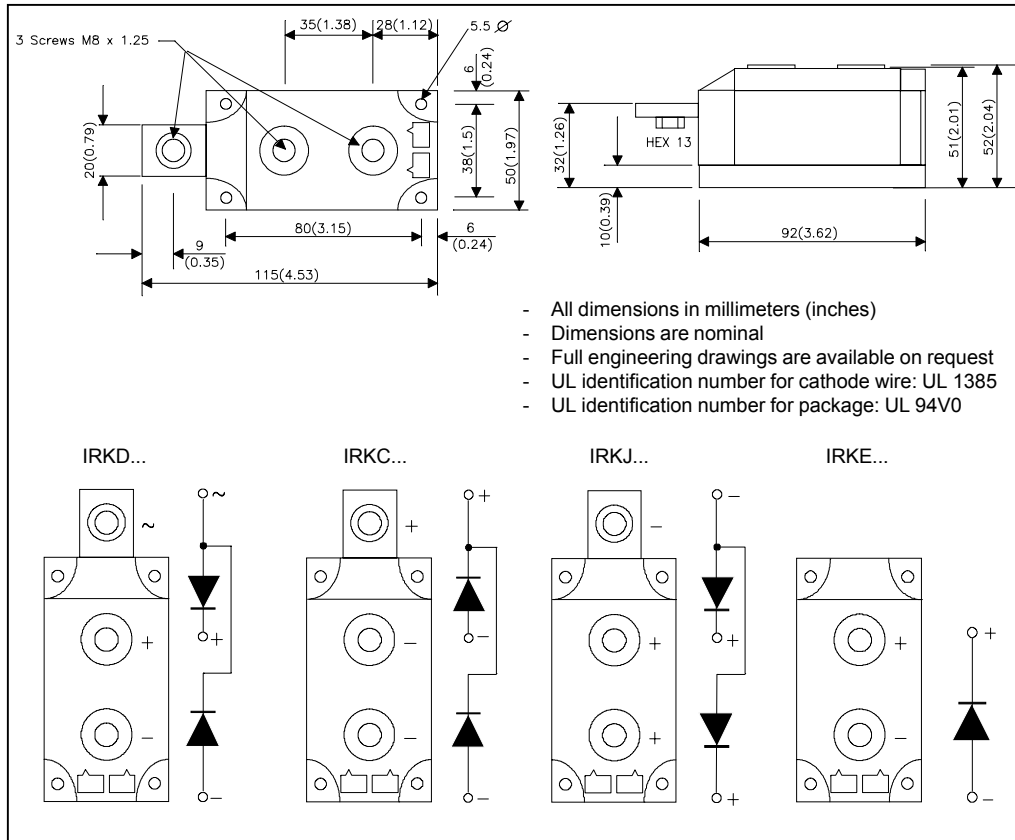

Fig. 1 - Current Ratings Characteristics

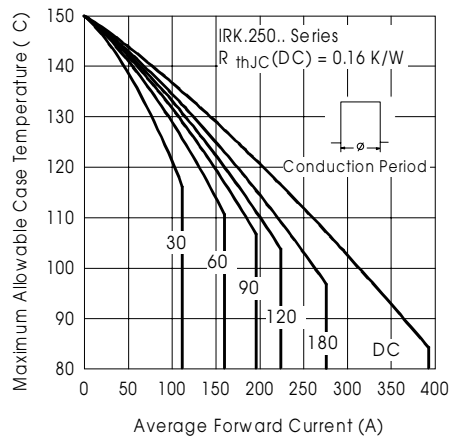

Fig. 2 - Current Ratings Characteristics

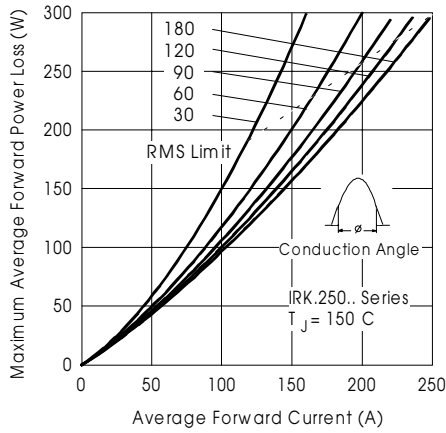

Fig. 3 - Forward Power Loss Characteristics

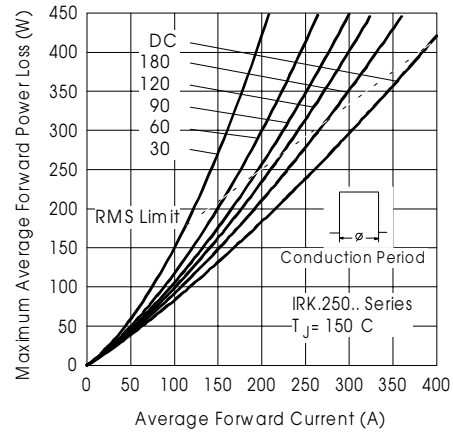

Fig. 4 - Forward Power Loss Characteristics

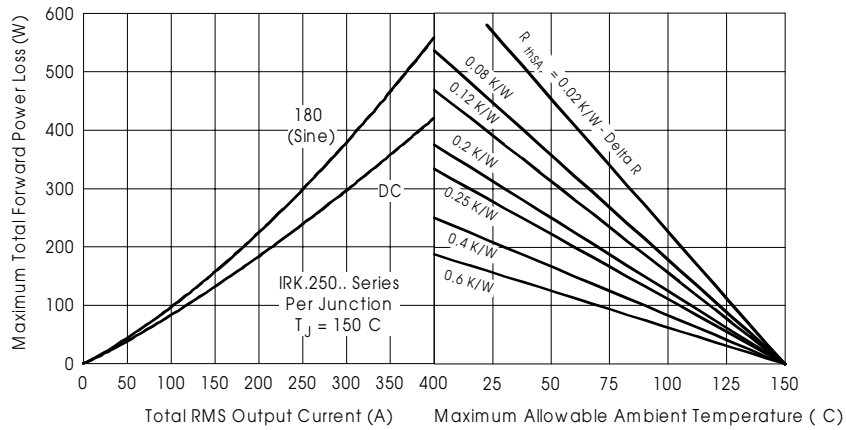

Fig. 5 - Forward Power Loss Characteristics

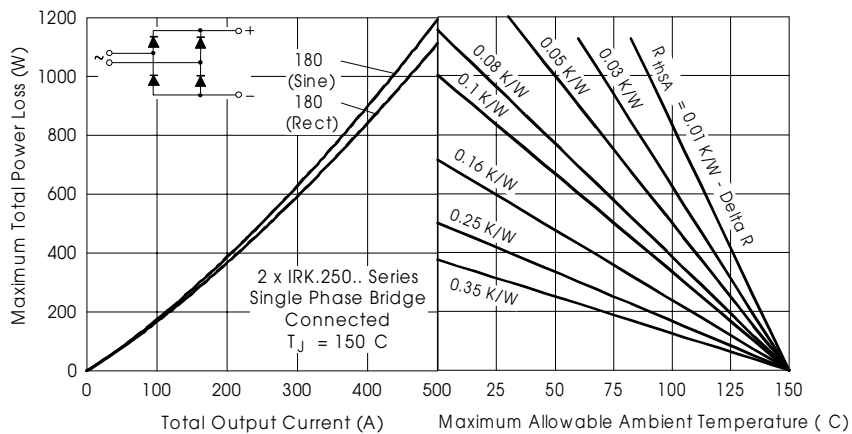

Fig. 6 - Forward Power Loss Characteristics

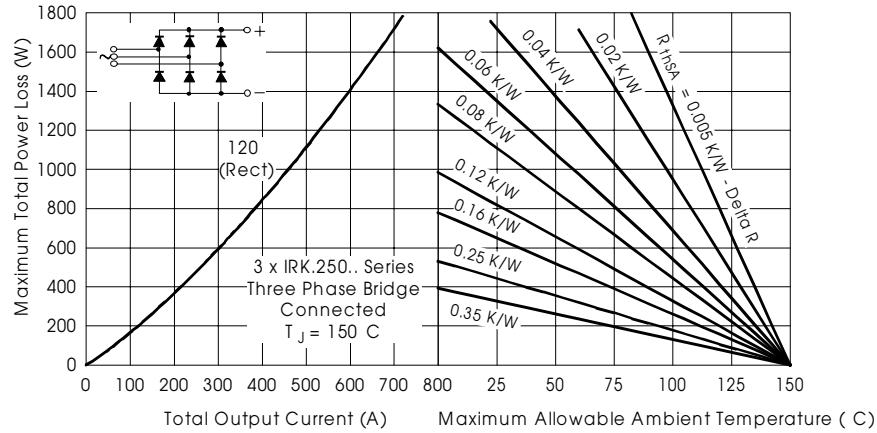

Fig. 7 - Forward Power Loss Characteristics

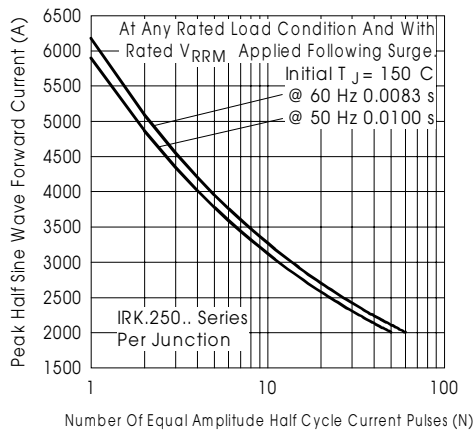

Fig. 8 - Maximum Non-Repetitive Surge Current

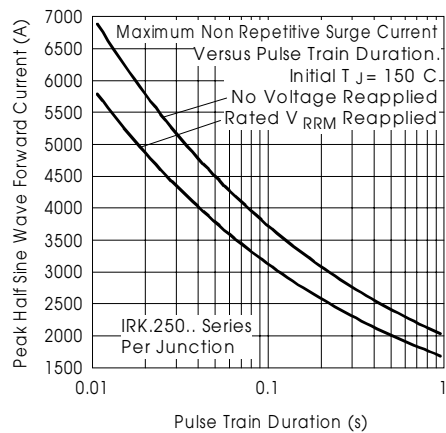

Fig. 9 - Maximum Non-Repetitive Surge Current

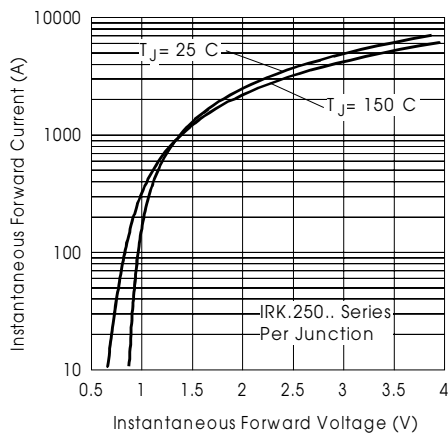

Fig. 10 - Forward Voltage Drop Characteristics

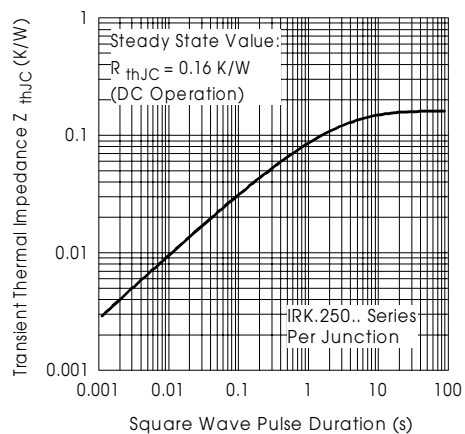

Fig. 11 - Thermal Impedance $Z_{\theta JC}$ Characteristics

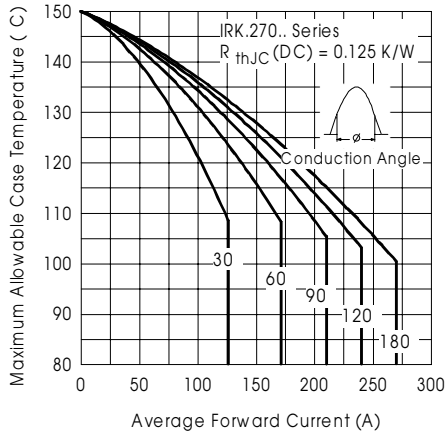

Fig. 12 - Current Ratings Characteristics

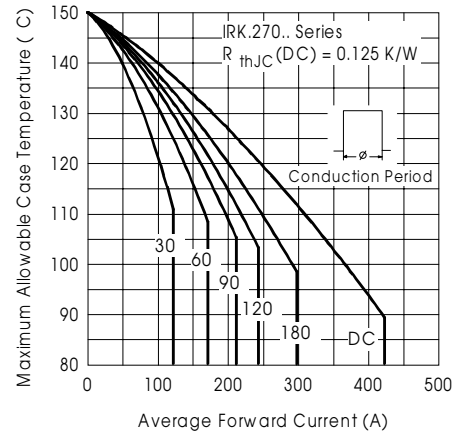

Fig. 13 - Current Ratings Characteristics

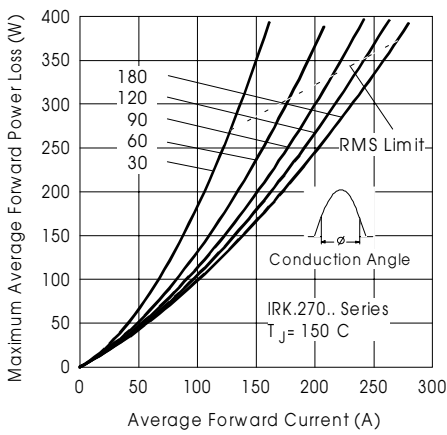

Fig. 14 - Forward Power Loss Characteristics

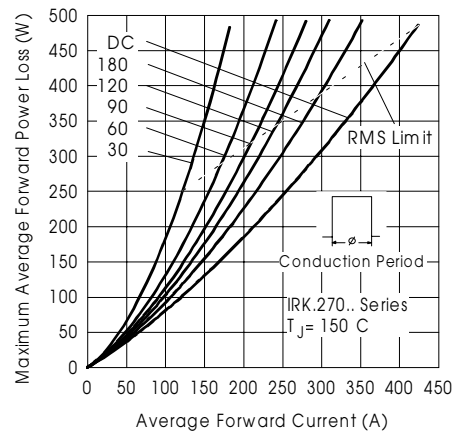

Fig. 15 - Forward Power Loss Characteristics

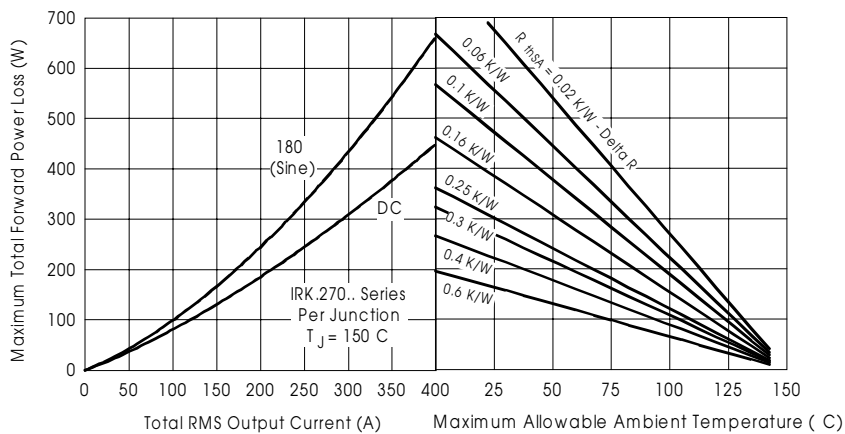

Fig. 16 - Forward Power Loss Characteristics

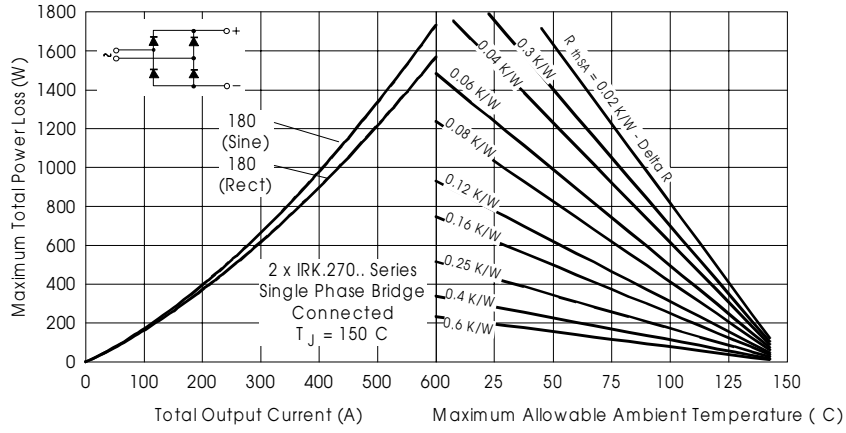

Fig. 17 - Forward Power Loss Characteristics

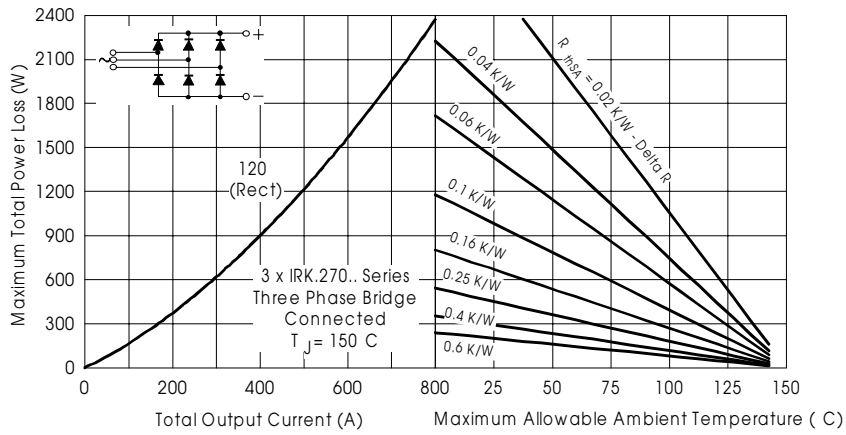

Fig. 18 - Forward Power Loss Characteristics

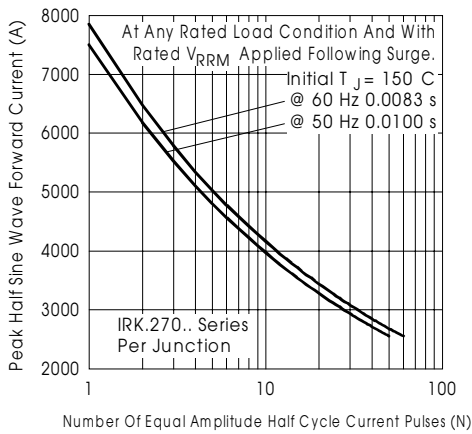

Fig. 19 - Maximum Non-Repetitive Surge Current

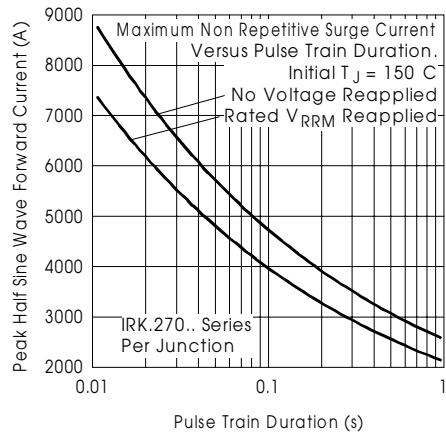

Fig. 20 - Maximum Non-Repetitive Surge Current

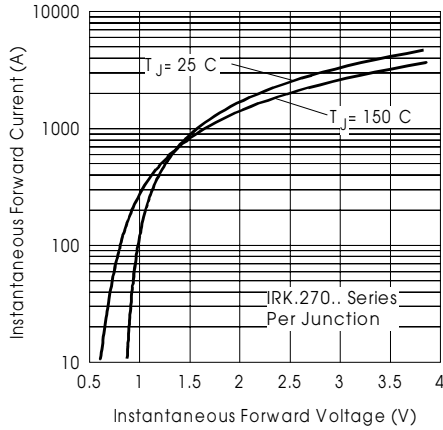

Fig. 21 - Forward Voltage Drop Characteristics

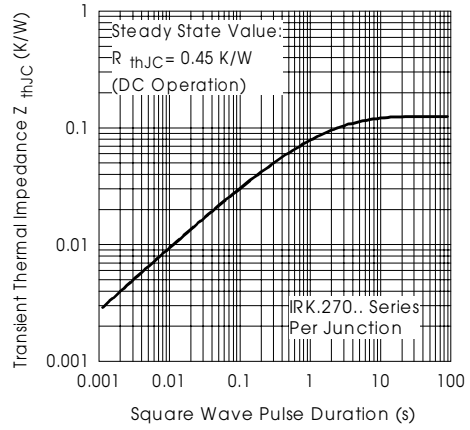

Fig. 22 - Thermal Impedance Z_{thJC} Characteristics

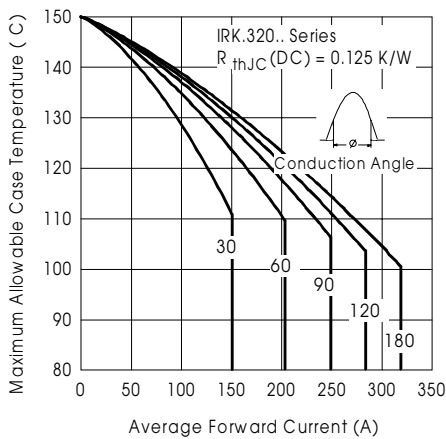

Fig. 23 - Current Ratings Characteristics

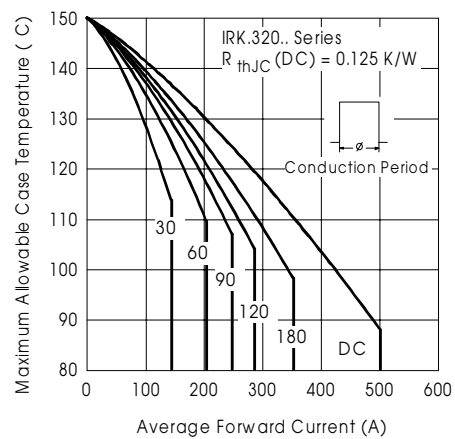

Fig. 24 - Current Ratings Characteristics

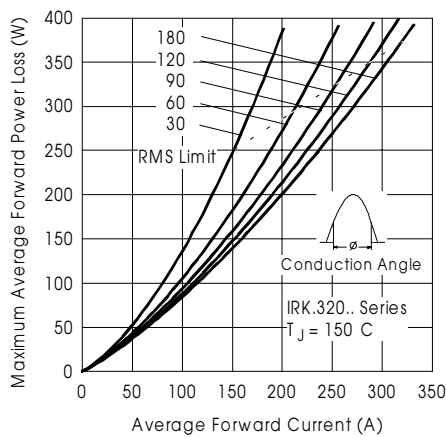

Fig. 25 - Forward Power Loss Characteristics

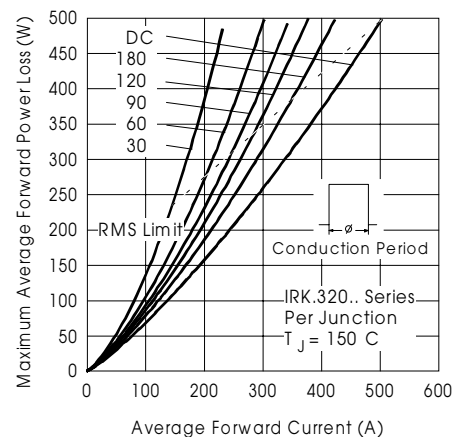

Fig. 26 - Forward Power Loss Characteristics

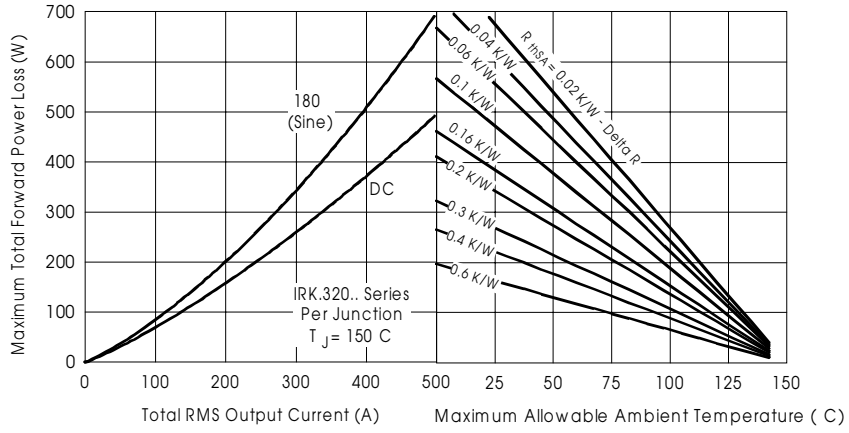

Fig. 27 - Forward Power Loss Characteristics

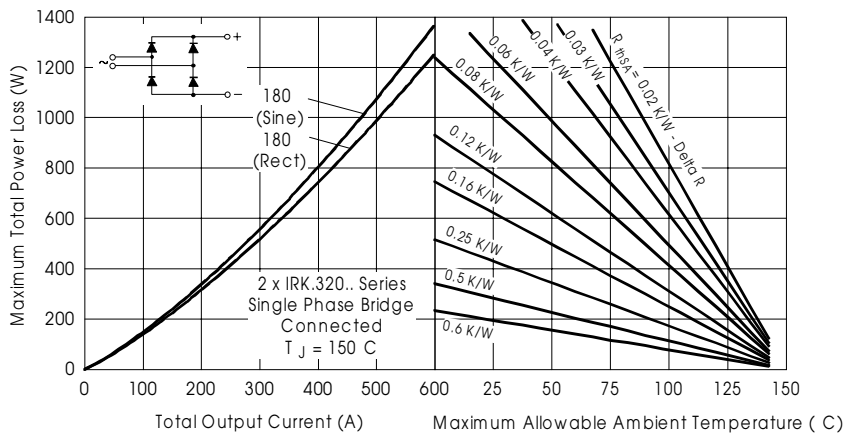

Fig. 28 - Forward Power Loss Characteristics

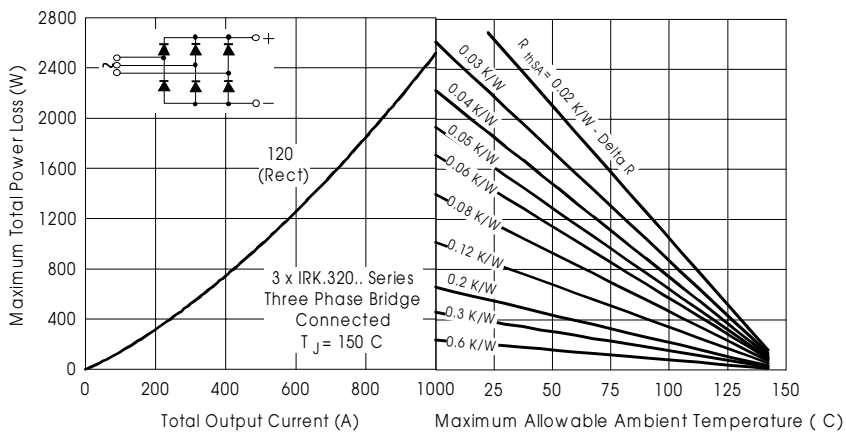

Fig. 29 - Forward Power Loss Characteristics

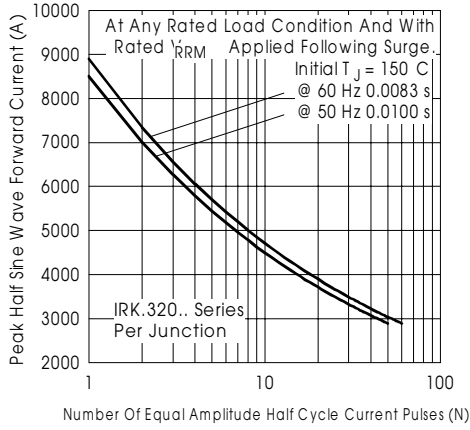

Fig. 30 - Maximum Non-Repetitive Surge Current

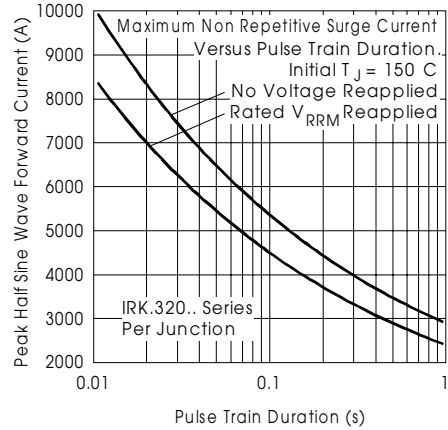

Fig. 31 - Maximum Non-Repetitive Surge Current

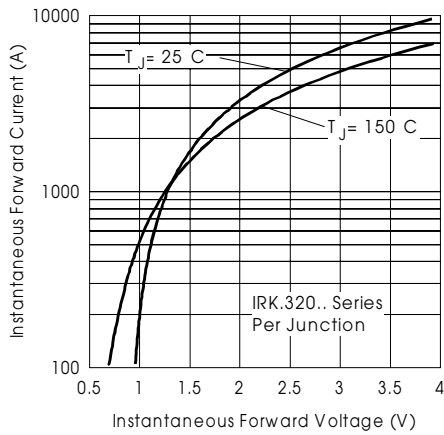

Fig. 32 - Forward Voltage Drop Characteristics

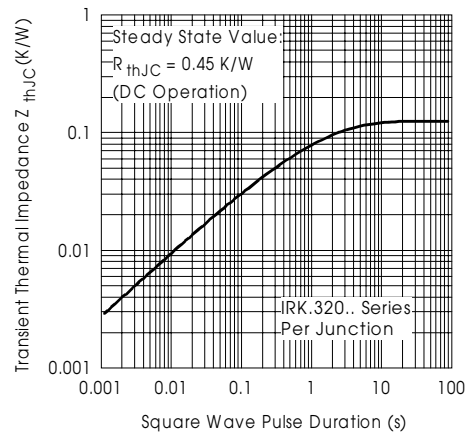

Fig. 33 - Thermal Impedance Z_{thJC} Characteristics

Data and specifications subject to change without notice.
 This product has been designed and qualified for Industrial Level.
 Qualification Standards can be found on IR's Web site.