

DIODE MODULE 50A/800V

PT50S8

FEATURES

- * Isolated Base
- * 3 Phase Bridge Circuit
- * Designed Power Circuit Board
- * High Surge Capability
- * UL Recognized, File No. E187184

TYPICAL APPLICATIONS

- * Rectified For General Use

OUTLINE DRAWING

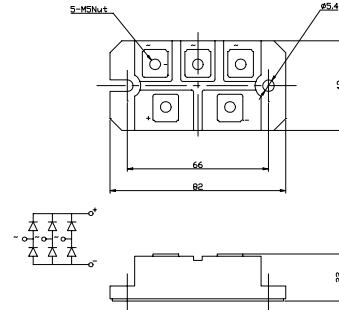

Maximum Ratings

Approx Net Weight:180g

Parameter	Symbol	Type / Grade	Unit
		PT50S8	
Repetitive Peak Reverse Voltage *1	V_{RRM}	800	V
Non Repetitive Peak Reverse Voltage *1	V_{RSM}	1000	

Parameter		Conditions	Max Rated Value	Unit
Average Rectified Output Current	$I_{O(AV)}$	3-Phase Full Wave Rectified $T_c = T_t(\text{Terminal}) = 111^\circ\text{C}$	50	A
Surge Forward Current *1	I_{FSM}	50 Hz Half Sine Wave, 1Pulse Non-repetitive	450	A
I Squared t *1	I^2t	2msec to 10msec	1000	A ² s
Operating Junction Temperature Range	T_{jw}		-40 to +150	°C
Storage Temperature Range	T_{stg}		-40 to +125	°C
Isolation Voltage	Viso	Base Plate to Terminals, AC1min	2000	V
Mounting torque	Case mounting	Greased	M5 Screw	N.m
	Terminals	M5		
	F_{tor}		2.4 to 2.8	

Electrical • Thermal Characteristics

Characteristics	Symbol	Test Conditions	Max.	Unit
Peak Reverse Current *1	I_{RM}	$V_{RM} = V_{RRM}$, $T_j = 150^\circ\text{C}$	10	mA
Peak Forward Voltage *1	V_{FM}	$I_{FM} = 50\text{A}$, $T_j = 25^\circ\text{C}$	1.2	V
Thermal Resistance	$R_{th(j-c)}$	Junction to Case (Total)	0.35	°C/W
	$R_{th(c-f)}$	Base Plate to Heat Sink with Thermal Compound (Total)	0.06	

*1: Value Per 1Arm

PT50S8 OUTLINE DRAWING (Dimensions in mm)

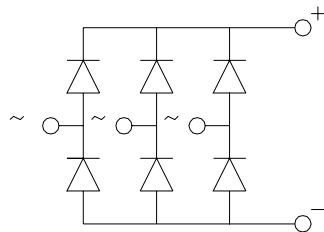
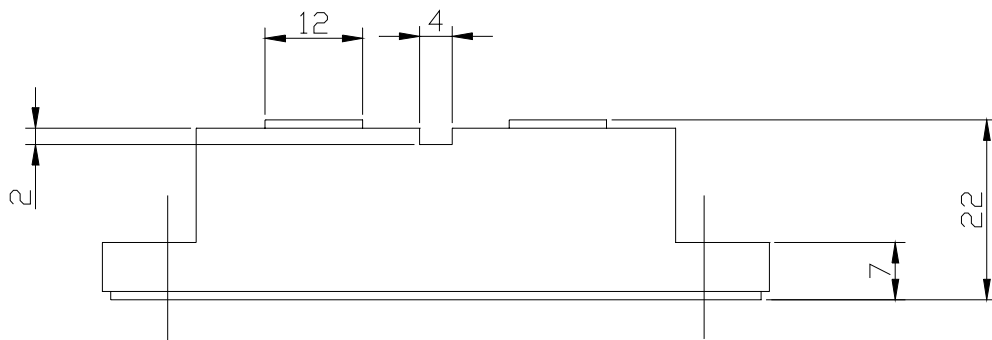
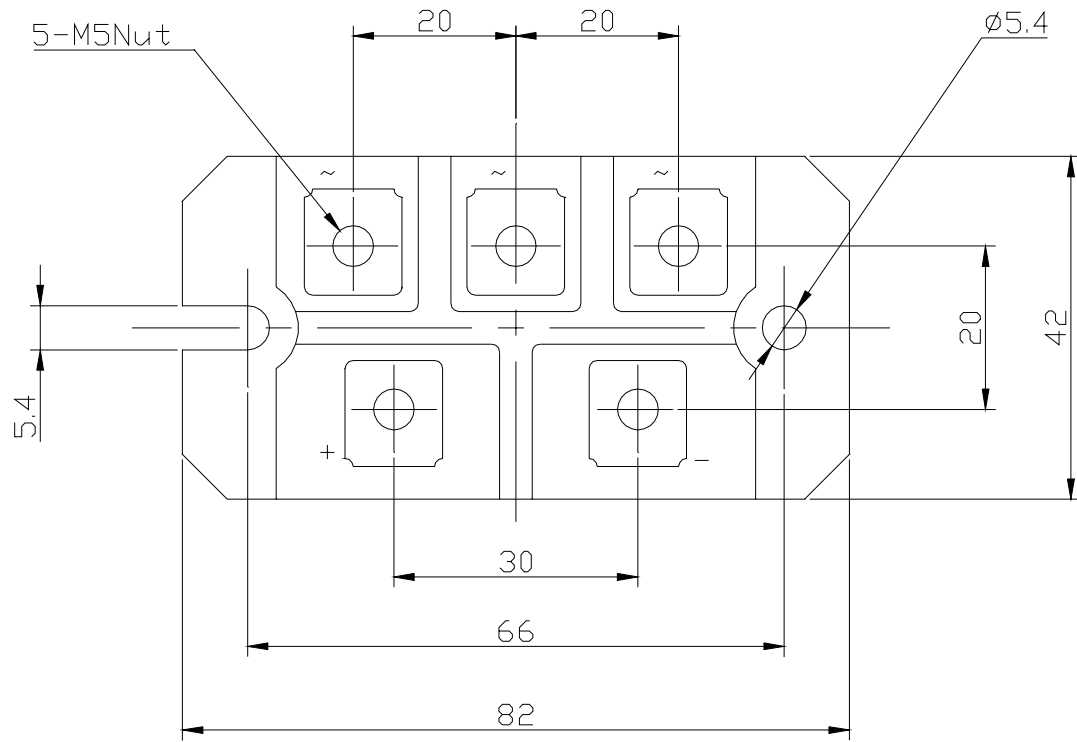

FORWARD CURRENT VS. VOLTAGE

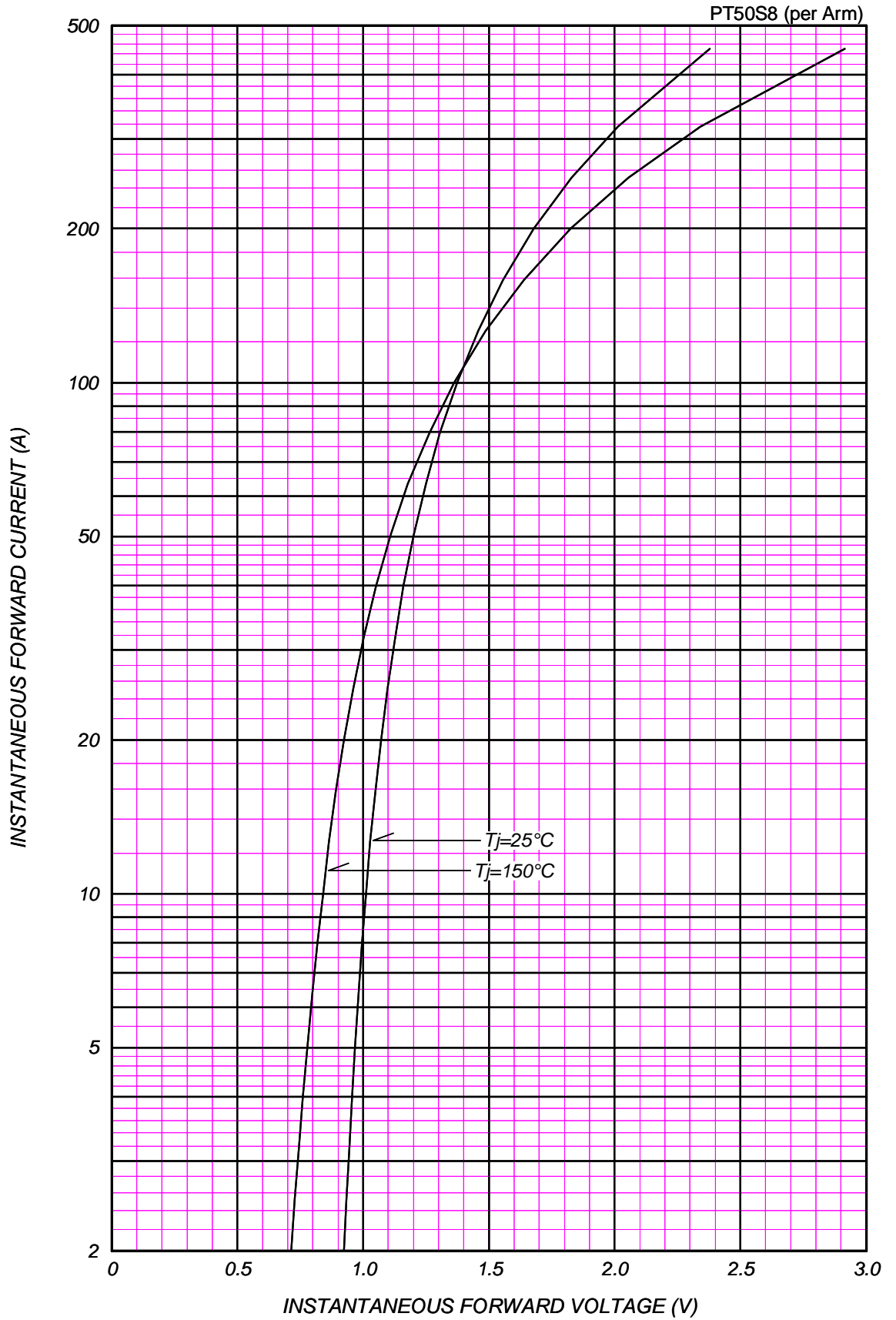

AVERAGE FORWARD POWER DISSIPATION

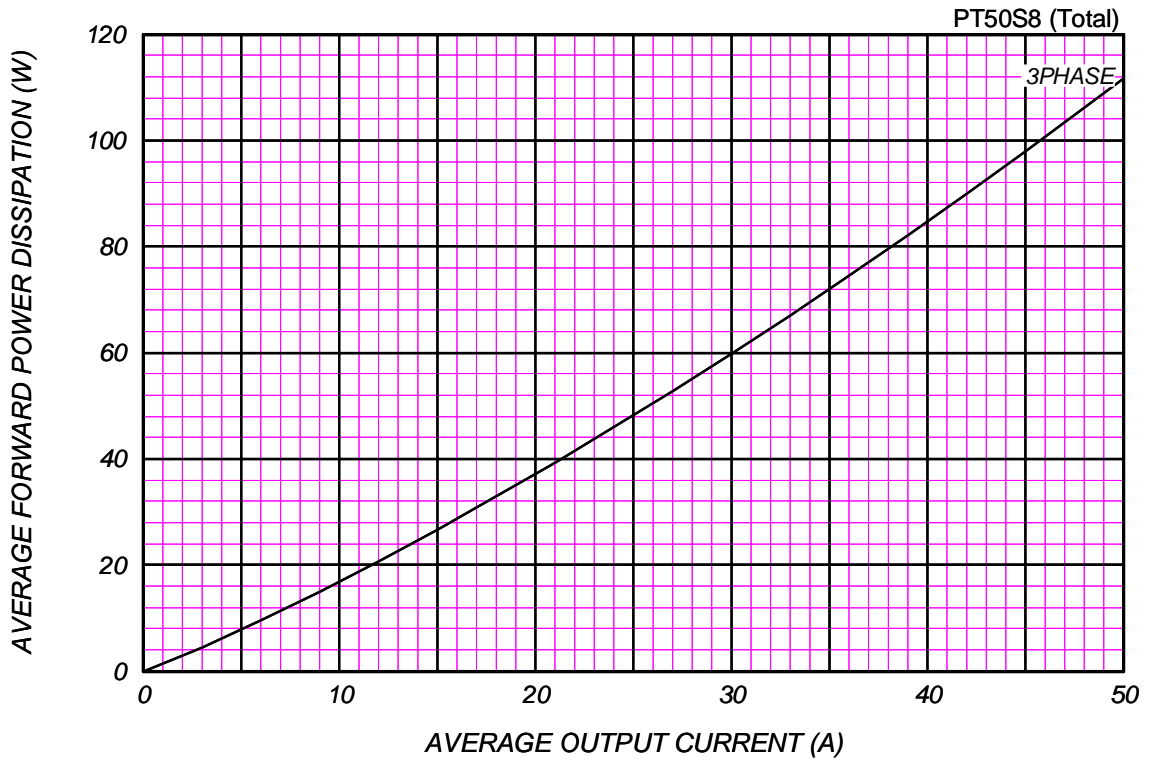

AVERAGE OUTPUT CURRENT VS. CASE TEMPERATURE

3-Phase Full Wave, Resistive or Inductive Load

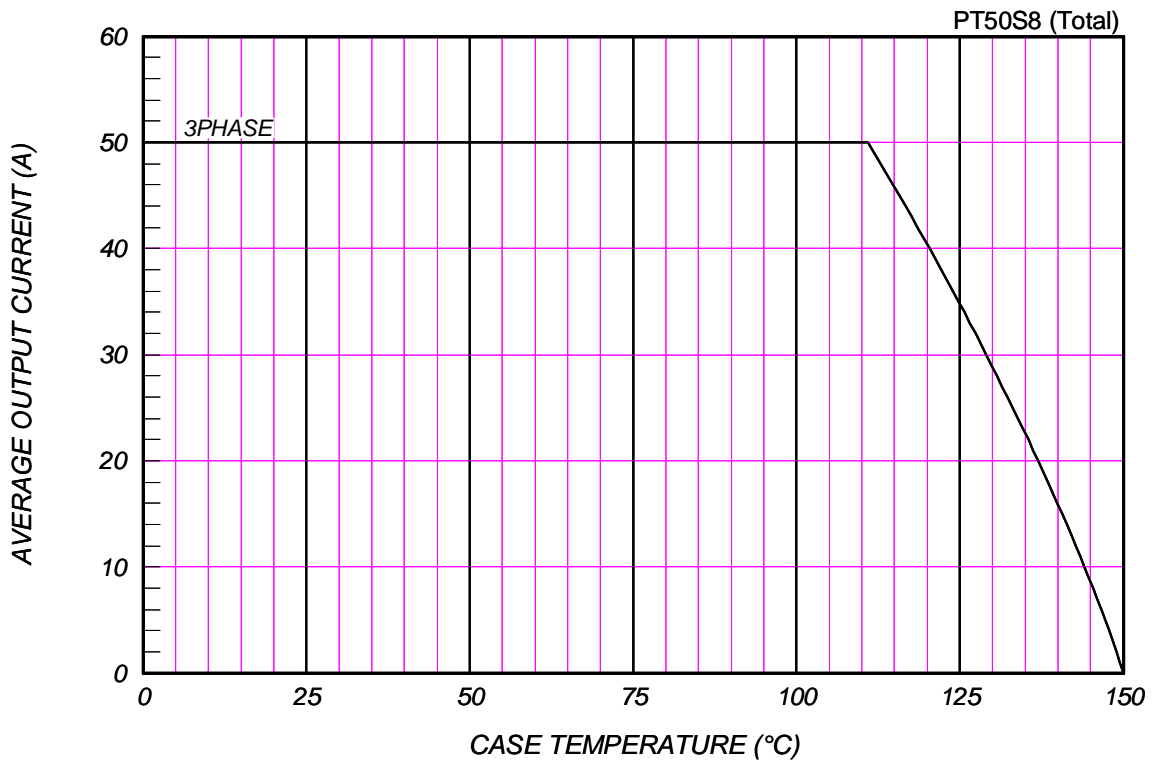

SURGE CURRENT RATINGS

f=50Hz,Half Sine Wave,Non-Repetitive,T_j=150°C

PT50S8

