

Powerex, Inc., Hillis Street, Youngwood, Pennsylvania 15697 (724) 925-7272

POW-R-BLOK™ Dual DIODE Module 120 Amperes / Up to 2400 Volts

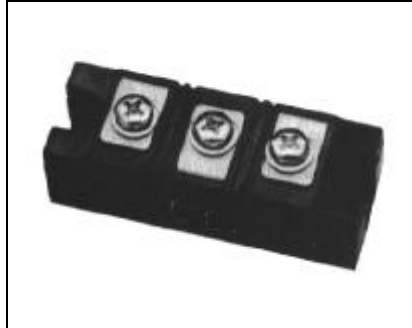
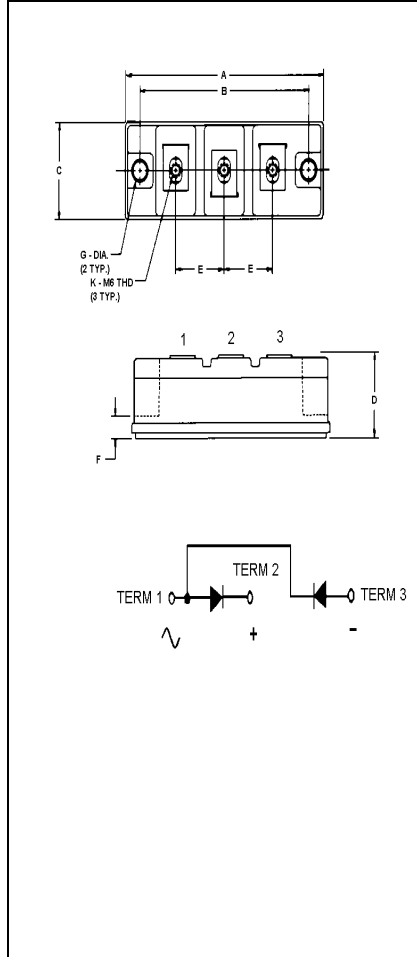

Description:

Powerex Dual Diode Modules are designed for use in applications requiring rectification and isolated packaging. The modules are isolated for easy mounting with other components on a common heatsink.

Features:

- Electrically Isolated Heatsinking
- Metal Baseplate
- Low Thermal Impedance for Improved Current Capability
- UL Recognition Pending

Applications:

- Battery Supplies
- Bridge Circuits
- AC & DC Motor Control
- Rectifiers

Dimensions

Dimension	Inches		Metric	
	Min.	Max.	Min.	Max.
A	3.681	3.721	93.50	94.51
B	3.145	3.155	79.88	80.14
C	1.329	1.349	33.76	34.26
D	1.160	1.200	29.51	30.53
E	.901	.911	22.88	23.14
F	.305	.325	7.75	8.26
K			M6 x 0.8	
GØ	.251	.261	6.38	6.63

Note: Dimensions are for reference only.

Powerex, Inc., Hillis Street, Youngwood, Pennsylvania 15697 (724) 925-7272

QRD2412001
Diode POW-R-BLOK™ Modules
120 Amperes / Up to 2400 Volts

Absolute Maximum Ratings

Characteristics	Conditions	Symbol		Units
Repetitive Peak Reverse Blocking Voltage		V_{RRM}	up to 2400	V
Non-Repetitive Peak Reverse Blocking Voltage		V_{RSM}	$V_{RRM} + 100$	V
RMS Forward Current		$I_{F(RMS)}$	195	A
Average Forward Current	180° Conduction, $T_C=106^\circ\text{C}$	$I_{F(AV)}$	120	A
Peak Half Cycle Non-Repetitive Surge Current	$t = 8.3\text{mS}$, 100% V_{RRM} reapplied	I_{FSM}	3500	A
Peak Half Cycle Non-Repetitive Surge Current	$t = 10\text{mS}$, 100% V_{RRM} reapplied	I_{FSM}	3350	A
I^2t for Fusing for One Cycle	$t = 8.3\text{mS}$, 100% V_{RRM} reapplied	I^2t	52,000	$\text{A}^2\text{-sec}$
I^2t for Fusing for One Cycle	$t = 10\text{mS}$, 100% V_{RRM} reapplied	I^2t	56,000	$\text{A}^2\text{-sec}$
Operating Junction Temperature		T_J	-40 to +150	$^\circ\text{C}$
Storage Temperature		T_{stg}	-40 to +150	$^\circ\text{C}$
Maximum Mounting Torque, M6 Mounting Screw	--	--	4 to 6	Nm
Maximum Terminal Torque, M6 Terminal Screw	--	--	4 to 6	Nm
Module Weight, Typical	--	--	500 17.8	g oz
V Isolation		V_{RMS}	6000	Vrms

Powerex, Inc., Hillis Street, Youngwood, Pennsylvania 15697 (724) 925-7272

QRD2412001
Diode POW-R-BLOK™ Modules
120 Amperes / Up to 2400 Volts

Electrical and Thermal Characteristics, T_J=25°C unless otherwise specified

Characteristics	Symbol	Test Conditions	Min.	Typ.	Max	Units
Peak Reverse Leakage Current	I _{RRM}	T _J =150, Rated V _{RRM}			50	mA
Peak On-State Voltage	V _{FM}	I _{FM} =500A			1.55	V
Threshold Voltage, Low-level	V _{(TO)1}	T _J = 150°C, I = 15%I _{F(AV)} to πI _{F(AV)}				V
Slope Resistance, Low-level	r _{T1}					mΩ
Threshold Voltage, High-level	V _{(TO)2}	T _J = 150°C, I = πI _{F(AV)} to I _{FSM}				V
Slope Resistance, High-level	r _{T2}					mΩ
V _{FM} Coefficients, Full Range		T _J = 150°C, I = 15%I _{F(AV)} to I _{FSM}		A = 0.9591 B = -3.377 C = 9.9197 D = 5.3171		
		V _{FM} =A + B Ln I _{FM} + C I _{FM} + D Sqrt I _{FM}				

Thermal Characteristics

Characteristics	Symbol	Min.	Typ.	Max.	Units
Thermal Resistance, Junction to Case	R _{θJC}	-----	-----	0.10	°C/W
				0.20	°C/W
Thermal Resistance, Case to Sink Lubricated	R _{θCS}	-----	-----	0.035	°C/W

Powerex, Inc., Hillis Street, Youngwood, Pennsylvania 15697 (724) 925-7272

POW-R-BLOK Dual Diode Module 120 Amperes/ Up to 2400 Volts

Maximum On-State Forward Voltage Drop
($T_j = 150^\circ\text{C}$)

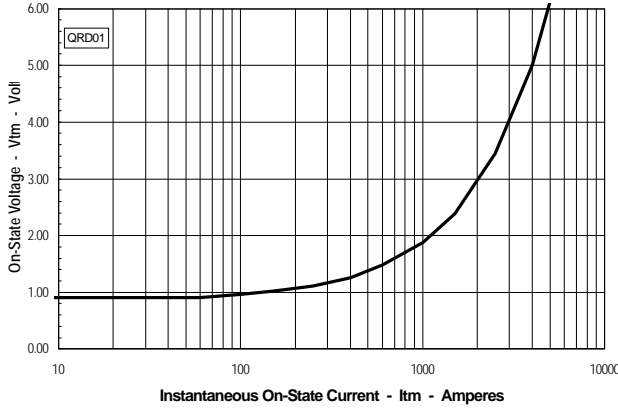

Maximum Transient Thermal Impedance
(Junction to Case)

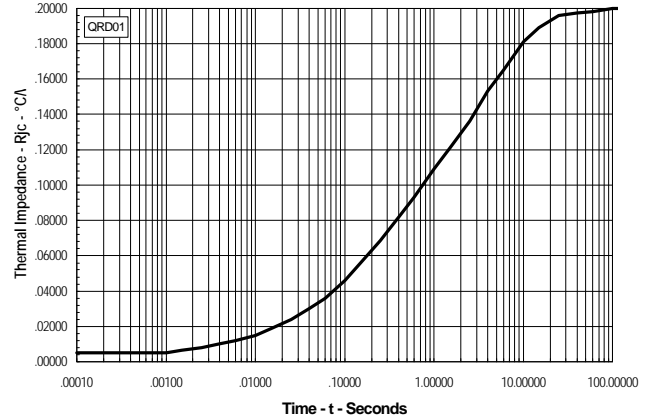

Maximum On-State Power Dissipation
(Sinusoidal Waveform)

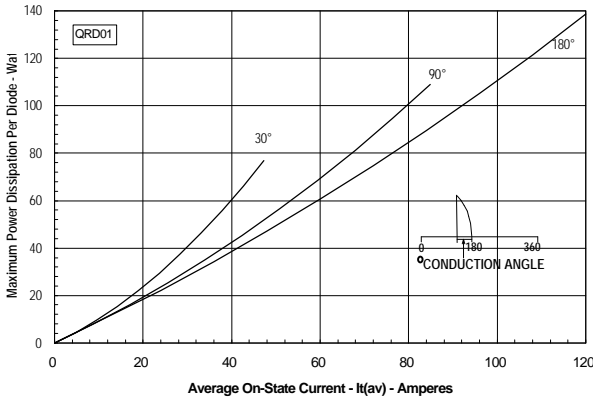

Maximum Allowable Case Temperature
(Sinusoidal Waveform)

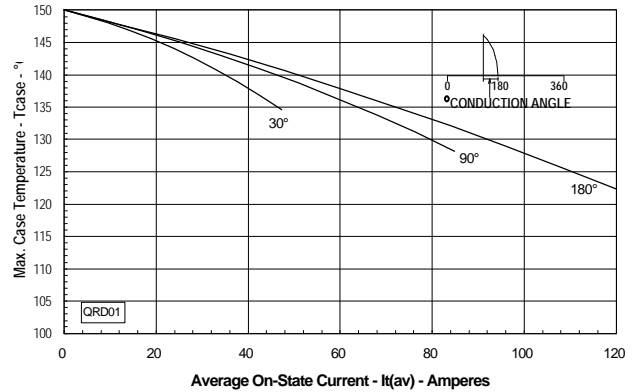

Maximum On-State Power Dissipation
(Rectangular Waveform)

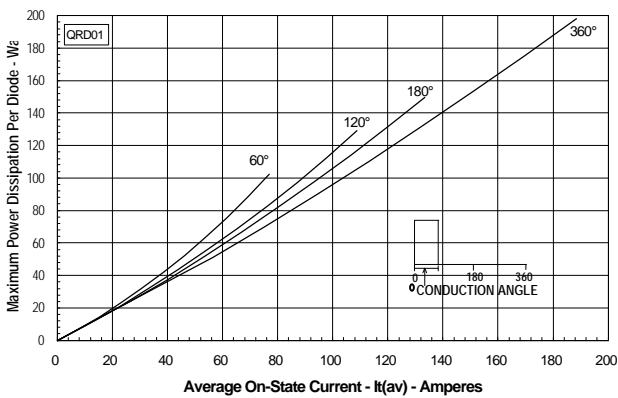

Maximum Allowable Case Temperature
(Rectangular Waveform)

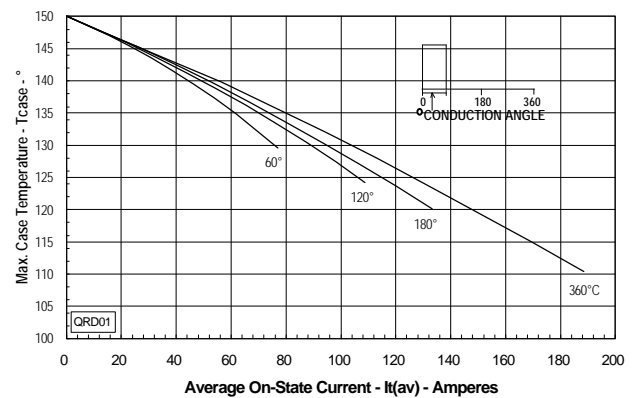

000000