

**Features**

- Wide current range
- High voltage ratings up to 2400V
- High surge current capabilities
- Stud cathode and stud anode version
- Standard JEDEC types

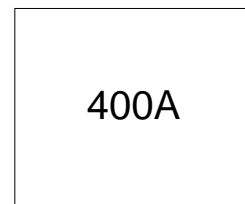

**Typical Applications**

- Converters
- Power supplies
- Machine tool controls
- High power drives
- Medium traction applications

**Major Ratings and Characteristics**

Parameters	SD400N/R	Units
$I_{F(AV)}$	400	A
@ $T_C$	120	°C
$I_{F(RMS)}$	630	A
$I_{FSM}$ @ 50Hz	8250	A
@ 60Hz	8640	A
$I^2t$ @ 50Hz	340	KA <sup>2</sup> s
@ 60Hz	311	KA <sup>2</sup> s
$V_{RRM}$ range	1600 to 2400	V
$T_J$	- 40 to 190	°C

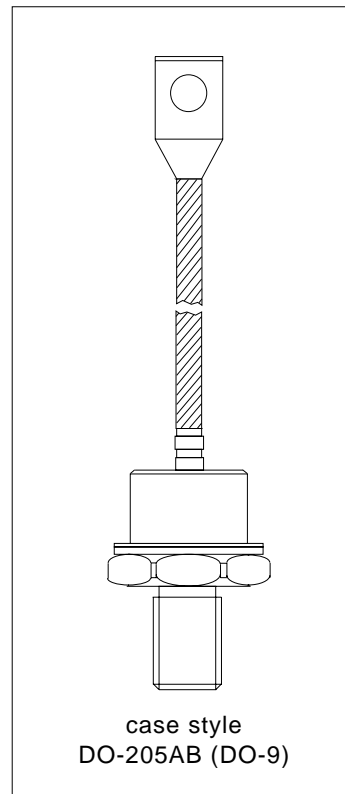

**ELECTRICAL SPECIFICATIONS**

## Voltage Ratings

Type number	Voltage Code	$V_{RRM}$ , maximum repetitive peak reverse voltage V	$V_{RSM}$ , maximum non-repetitive peak rev. voltage V	$I_{RRM}$ max. @ $T_J = T_J$ max. mA
SD400N/R	16	1600	1700	15
	20	2000	2100	
	24	2400	2500	

## Forward Conduction

Parameter	SD400N/R	Units	Conditions
$I_{F(AV)}$ Max. average forward current @ Case temperature	400	A	180° conduction, half sine wave
	120	°C	
$I_{F(AV)}$ Max. average forward current @ Case temperature	480	A	180° conduction, half sine wave
	100	°C	
$I_{F(RMS)}$ Max. RMS forward current	630	A	DC @ 110°C case temperature
$I_{FSM}$ Max. peak, one-cycle forward, non-repetitive surge current	8250	A	t = 10ms No voltage
	8640		t = 8.3ms reapplied
	6940		t = 10ms 100% $V_{RRM}$
	7270		t = 8.3ms reapplied
$I^2t$ Maximum $I^2t$ for fusing	340	KA <sup>2</sup> s	t = 10ms No voltage
	311		t = 8.3ms reapplied
	241		t = 10ms 100% $V_{RRM}$
	220		t = 8.3ms reapplied
$I^2\sqrt{t}$ Maximum $I^2\sqrt{t}$ for fusing	3400	KA <sup>2</sup> /s	t = 0.1 to 10ms, no voltage reapplied
$V_{F(TO)1}$ Low level value of threshold voltage	0.80	V	$(16.7\% \times \pi \times I_{F(AV)} < I < \pi \times I_{F(AV)})$ , $T_J = T_J$ max.
$V_{F(TO)2}$ High level value of threshold voltage	0.85		$(I > \pi \times I_{F(AV)})$ , $T_J = T_J$ max.
$r_{f1}$ Low level value of forward slope resistance	0.55	mΩ	$(16.7\% \times \pi \times I_{F(AV)} < I < \pi \times I_{F(AV)})$ , $T_J = T_J$ max.
$r_{f2}$ High level value of forward slope resistance	0.51		$(I > \pi \times I_{F(AV)})$ , $T_J = T_J$ max.
$V_{FM}$ Max. forward voltage drop	1.62	V	$I_{pk} = 1500A$ , $T_J = T_J$ max, $t_p = 10ms$ sinusoidal wave

**Thermal and Mechanical Specifications**

Parameter	SD400N/R	Units	Conditions
T <sub>J</sub> Max. junction operating temperature range	-40 to 190	°C	
T <sub>stg</sub> Max. storage temperature range	-55 to 200		
R <sub>thJC</sub> Max. thermal resistance, junction to case	0.11	K/W	DC operation
R <sub>thCS</sub> Max. thermal resistance, case to heatsink	0.04		Mounting surface, smooth, flat and greased
T Max. allowed mounting torque ±10%	27	Nm	Not lubricated threads
wt Approximate weight	250	g	
Case style	DO-205AB (DO-9)		See Outline Table

**ΔR<sub>thJC</sub> Conduction**

(The following table shows the increment of thermal resistance R<sub>thJC</sub> when devices operate at different conduction angles than DC)

Conduction angle	Sinusoidal conduction	Rectangular conduction	Units	Conditions
180°	0.020	0.013	K/W	T <sub>J</sub> = T <sub>J</sub> max.
120°	0.023	0.023		
90°	0.029	0.031		
60°	0.042	0.044		
30°	0.073	0.074		

**Ordering Information Table**

**Device Code**

SD	40	0	N	24	P	C
1	2	3	4	5	6	7

- 1** - Diode
- 2** - Essential part number
- 3** - 0 = Standard recovery
- 4** - N = Stud Normal Polarity (Cathode to Stud)  
R = Stud Reverse Polarity (Anode to Stud)
- 5** - Voltage code: Code x 100 = V<sub>RRM</sub> (See Voltage Ratings table)
- 6** - P = Stud base DO-205AB (DO-9) 3/4" 16UNF-2A
- 7** - C = Ceramic Housing

NOTE: For Metric Device M16 x 1.5 Contact Factory

**SD400N/R Series**

Bulletin I2082 rev. D 03/03

Outline Table

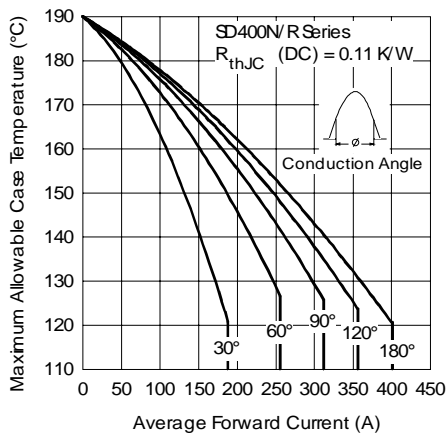
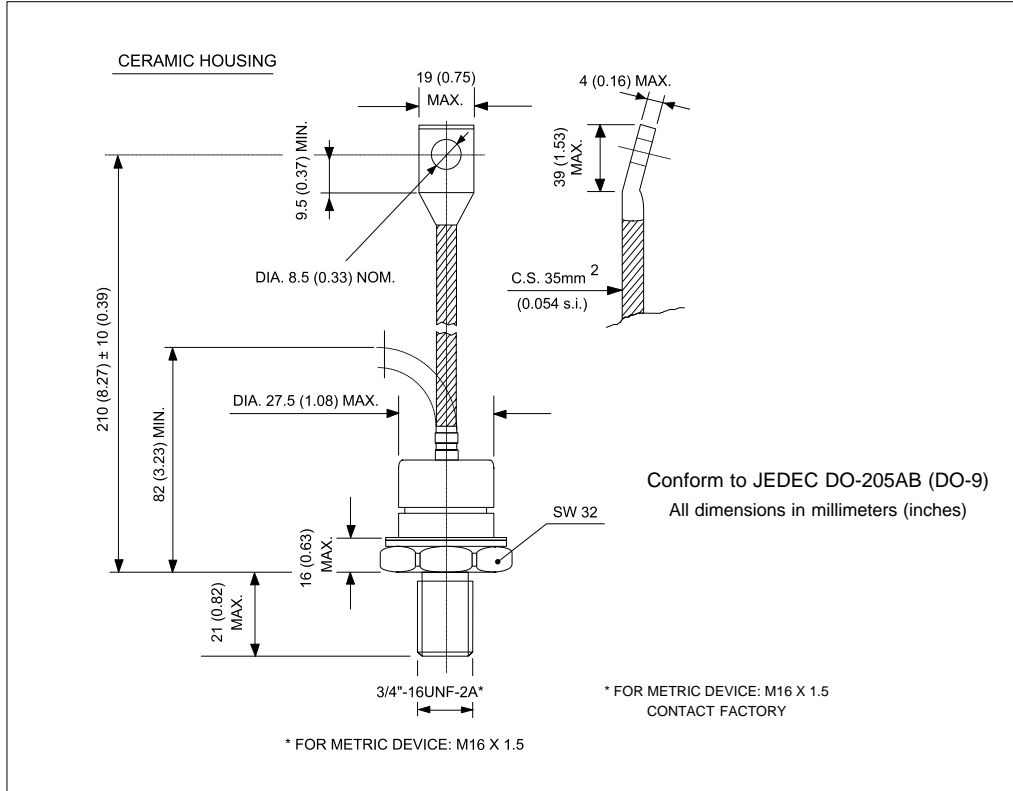

Fig. 1 - Current Ratings Characteristics

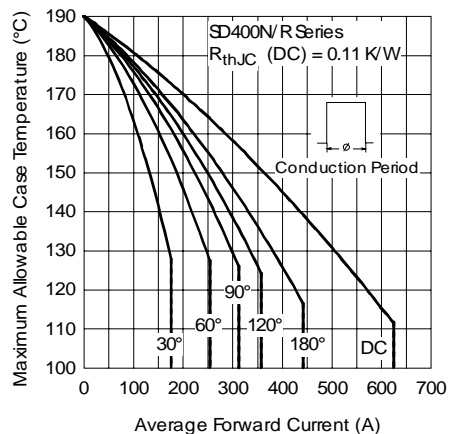

Fig. 2 - Current Ratings Characteristics

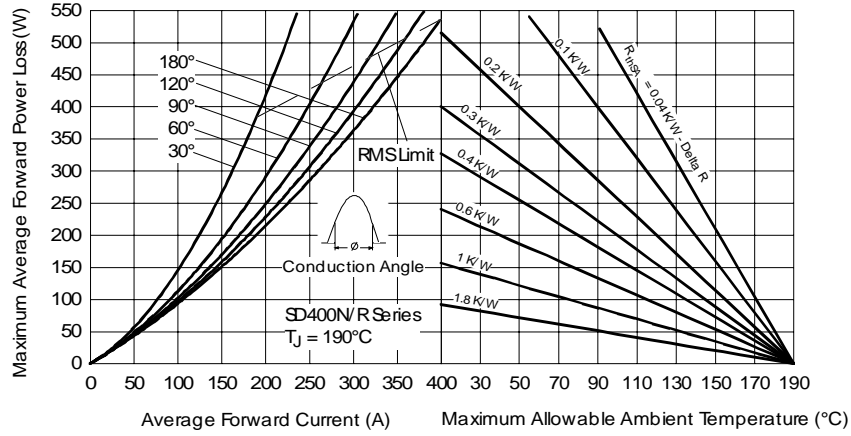

Fig. 3 - Forward Power Loss Characteristics

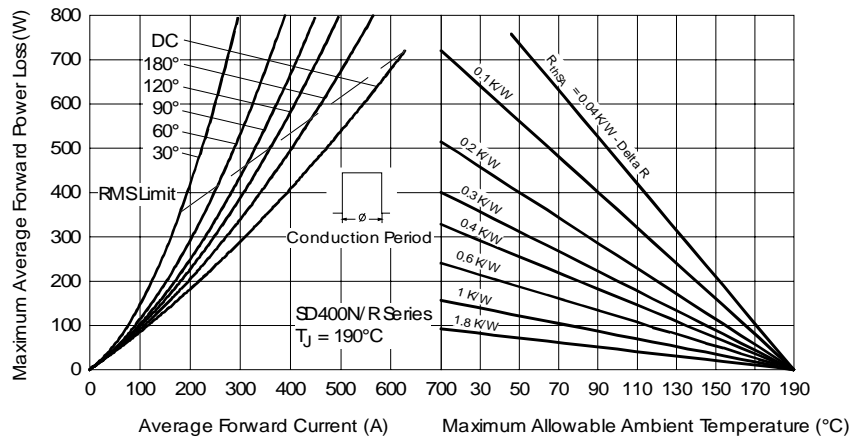

Fig. 4 - Forward Power Loss Characteristics

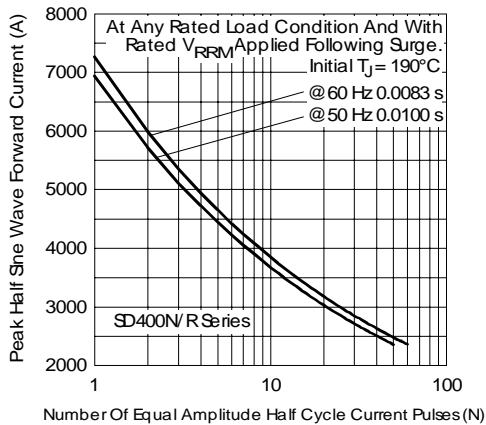

Fig. 5 - Maximum Non-Repetitive Surge Current

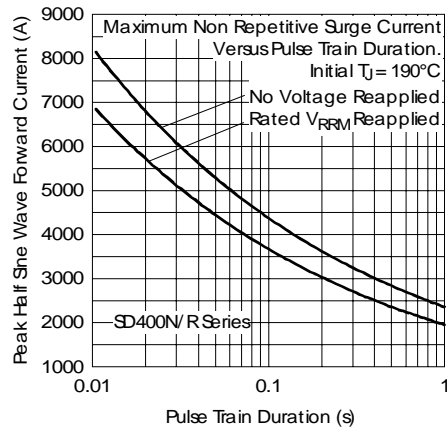

Fig. 6 - Maximum Non-Repetitive Surge Current

**SD400N/R Series**

Bulletin I2082 rev. D 03/03

International  
**IR** Rectifier

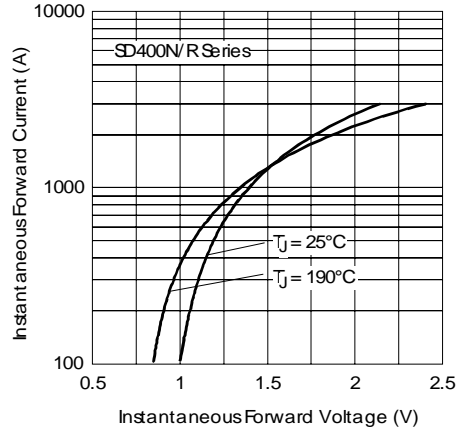

Fig. 7 - Forward Voltage Drop Characteristics

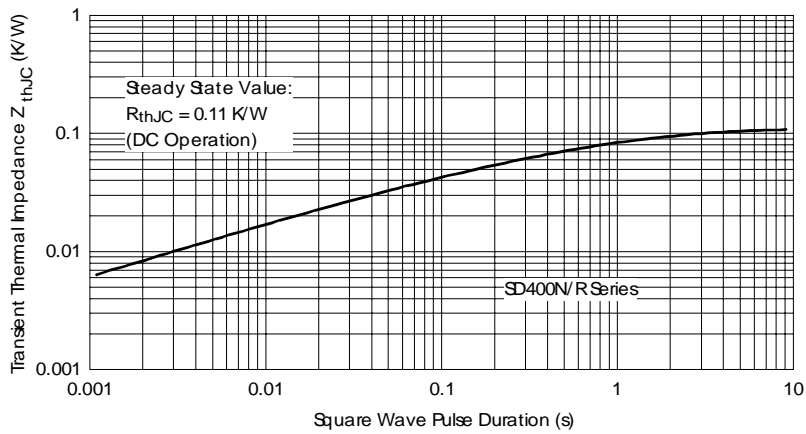

Fig. 8 - Thermal Impedance  $Z_{thJC}$  Characteristic

Data and specifications subject to change without notice.  
This product has been designed and qualified for Industrial Level.  
Qualification Standards can be found on IR's Web site.

International  
**IR** Rectifier

**IR WORLD HEADQUARTERS:** 233 Kansas St., El Segundo, California 90245, USA Tel: (310) 252-7105  
TAC Fax: (310) 252-7309  
Visit us at [www.irf.com](http://www.irf.com) for sales contact information. 03/03