

Features

- Wide current range
- High voltage ratings up to 2400V
- High surge current capabilities
- Stud cathode and stud anode version
- Standard JEDEC types

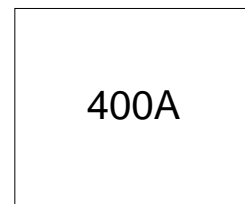

Typical Applications

- Converters
- Power supplies
- Machine tool controls
- High power drives
- Medium traction applications

Major Ratings and Characteristics

Parameters	SD400N/R	Units
$I_{F(AV)}$	400	A
@ T_C	120	°C
$I_{F(RMS)}$	630	A
I_{FSM} @ 50Hz	8250	A
@ 60Hz	8640	A
I^2t @ 50Hz	340	KA ² s
@ 60Hz	311	KA ² s
V_{RRM} range	1600 to 2400	V
T_J	- 40 to 190	°C

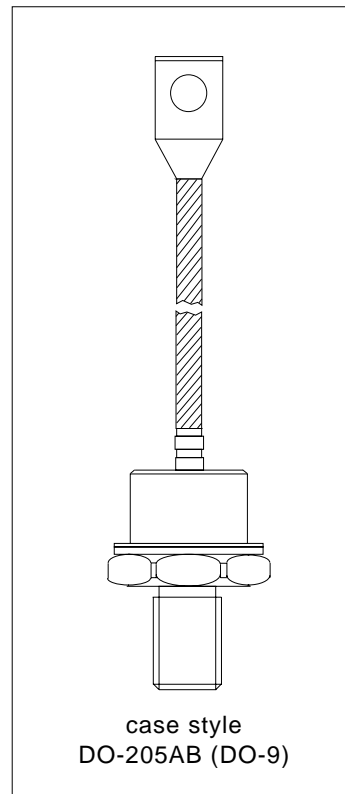

ELECTRICAL SPECIFICATIONS

Voltage Ratings

Type number	Voltage Code	V_{RRM} , maximum repetitive peak reverse voltage V	V_{RSM} , maximum non-repetitive peak rev. voltage V	I_{RRM} max. @ $T_J = T_J$ max. mA
SD400N/R	16	1600	1700	15
	20	2000	2100	
	24	2400	2500	

Forward Conduction

Parameter	SD400N/R	Units	Conditions
$I_{F(AV)}$ Max. average forward current @ Case temperature	400	A	180° conduction, half sine wave
	120	°C	
$I_{F(AV)}$ Max. average forward current @ Case temperature	480	A	180° conduction, half sine wave
	100	°C	
$I_{F(RMS)}$ Max. RMS forward current	630	A	DC @ 110°C case temperature
I_{FSM} Max. peak, one-cycle forward, non-repetitive surge current	8250	A	t = 10ms No voltage
	8640		t = 8.3ms reapplied
	6940		t = 10ms 100% V_{RRM}
	7270		t = 8.3ms reapplied
I^2t Maximum I^2t for fusing	340	KA ² s	t = 10ms No voltage
	311		t = 8.3ms reapplied
	241		t = 10ms 100% V_{RRM}
	220		t = 8.3ms reapplied
$I^2\sqrt{t}$ Maximum $I^2\sqrt{t}$ for fusing	3400	KA ² /s	t = 0.1 to 10ms, no voltage reapplied
$V_{F(TO)1}$ Low level value of threshold voltage	0.80	V	$(16.7\% \times \pi \times I_{F(AV)} < I < \pi \times I_{F(AV)})$, $T_J = T_J$ max.
$V_{F(TO)2}$ High level value of threshold voltage	0.85		$(I > \pi \times I_{F(AV)})$, $T_J = T_J$ max.
r_{f1} Low level value of forward slope resistance	0.55	mΩ	$(16.7\% \times \pi \times I_{F(AV)} < I < \pi \times I_{F(AV)})$, $T_J = T_J$ max.
r_{f2} High level value of forward slope resistance	0.51		$(I > \pi \times I_{F(AV)})$, $T_J = T_J$ max.
V_{FM} Max. forward voltage drop	1.62	V	$I_{pk} = 1500A$, $T_J = T_J$ max, $t_p = 10ms$ sinusoidal wave

Thermal and Mechanical Specifications

Parameter	SD400N/R	Units	Conditions
T _J Max. junction operating temperature range	-40 to 190	°C	
T _{stg} Max. storage temperature range	-55 to 200		
R _{thJC} Max. thermal resistance, junction to case	0.11	K/W	DC operation
R _{thCS} Max. thermal resistance, case to heatsink	0.04		Mounting surface, smooth, flat and greased
T Max. allowed mounting torque ±10%	27	Nm	Not lubricated threads
wt Approximate weight	250	g	
Case style	DO-205AB (DO-9)		See Outline Table

ΔR_{thJC} Conduction

(The following table shows the increment of thermal resistance R_{thJC} when devices operate at different conduction angles than DC)

Conduction angle	Sinusoidal conduction	Rectangular conduction	Units	Conditions
180°	0.020	0.013	K/W	T _J = T _J max.
120°	0.023	0.023		
90°	0.029	0.031		
60°	0.042	0.044		
30°	0.073	0.074		

Ordering Information Table

Device Code

SD	40	0	N	24	P	C
1	2	3	4	5	6	7

- 1** - Diode
- 2** - Essential part number
- 3** - 0 = Standard recovery
- 4** - N = Stud Normal Polarity (Cathode to Stud)
R = Stud Reverse Polarity (Anode to Stud)
- 5** - Voltage code: Code x 100 = V_{RRM} (See Voltage Ratings table)
- 6** - P = Stud base DO-205AB (DO-9) 3/4" 16UNF-2A
- 7** - C = Ceramic Housing

NOTE: For Metric Device M16 x 1.5 Contact Factory

SD400N/R Series

Bulletin I2082 rev. D 03/03

Outline Table

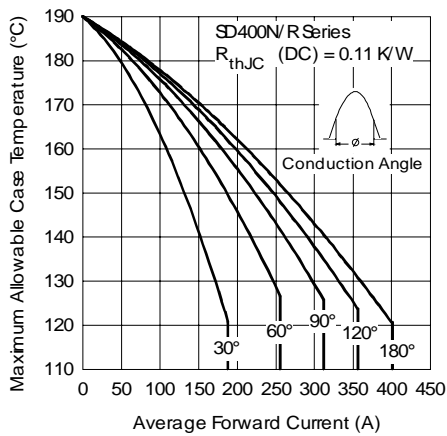
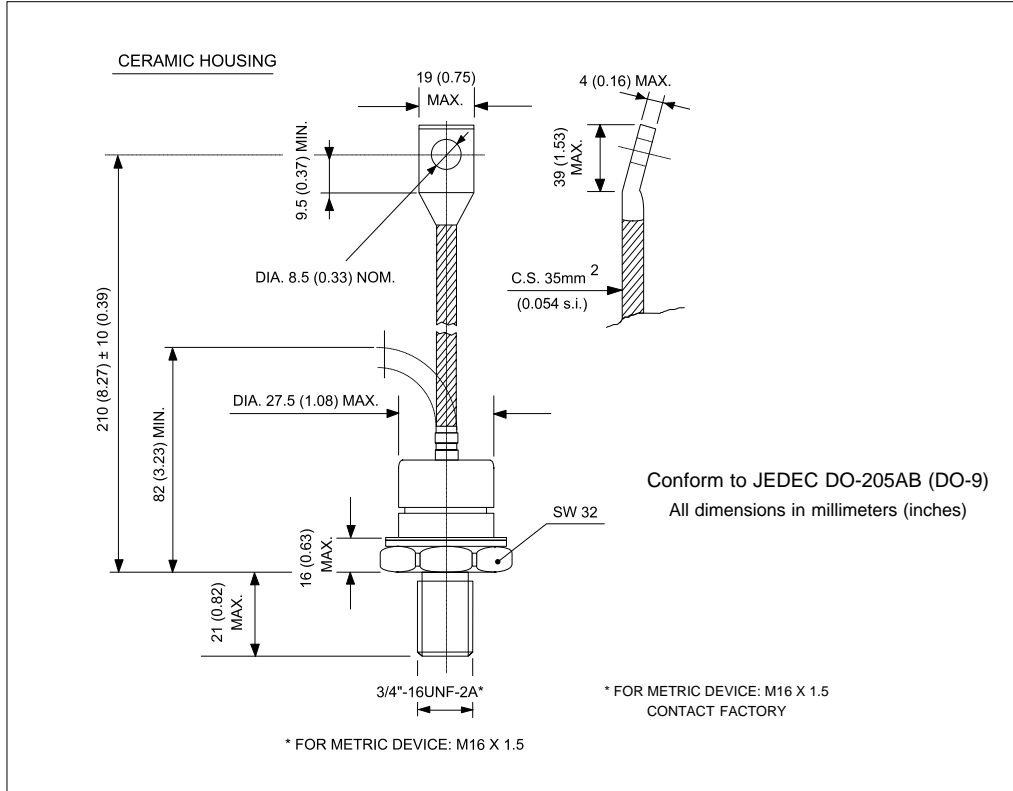

Fig. 1 - Current Ratings Characteristics

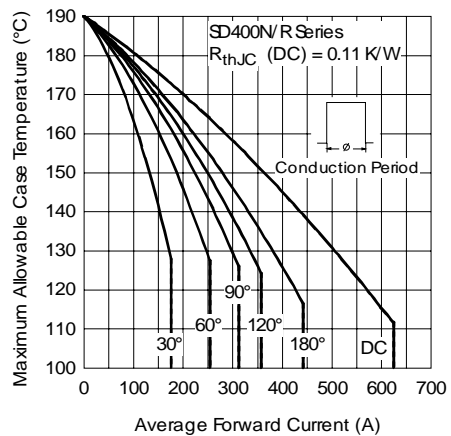

Fig. 2 - Current Ratings Characteristics

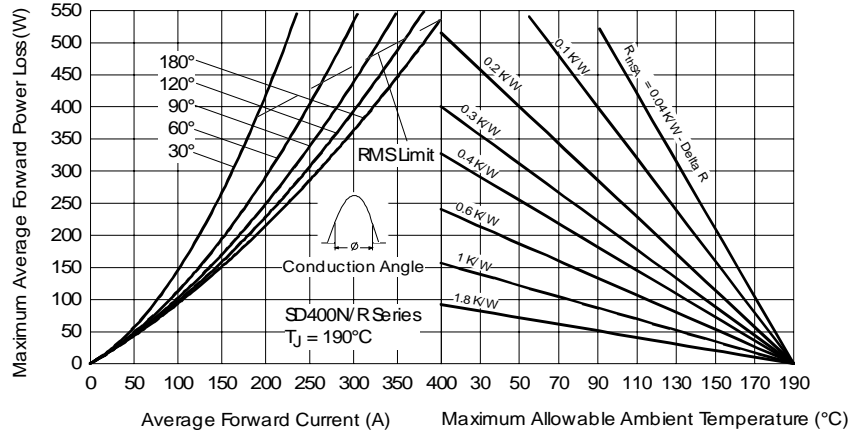

Fig. 3 - Forward Power Loss Characteristics

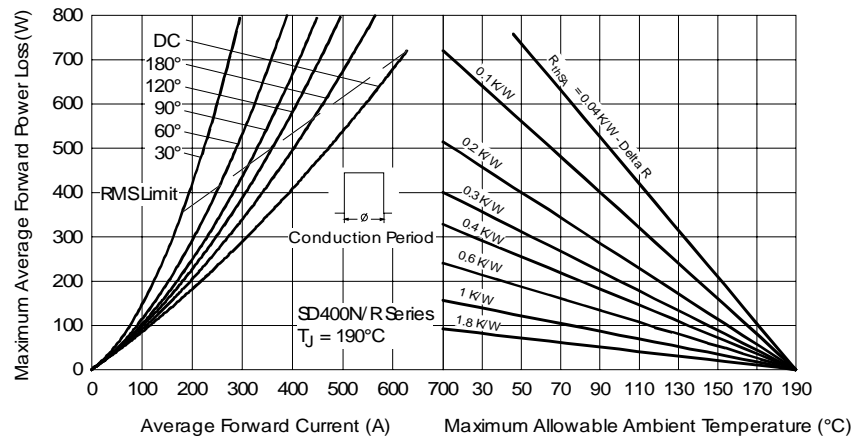

Fig. 4 - Forward Power Loss Characteristics

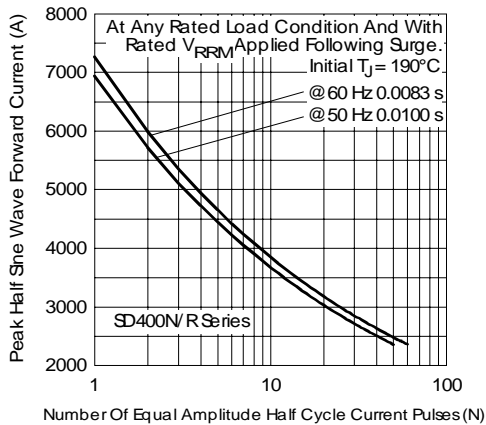

Fig. 5 - Maximum Non-Repetitive Surge Current

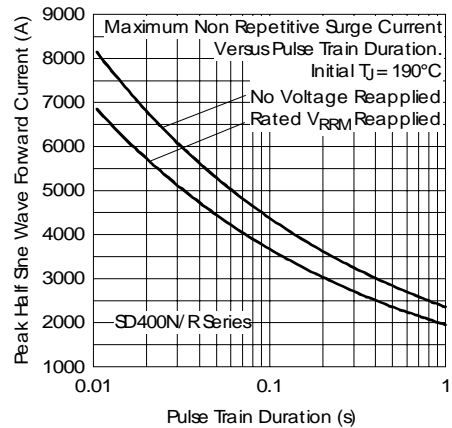

Fig. 6 - Maximum Non-Repetitive Surge Current

SD400N/R Series

Bulletin I2082 rev. D 03/03

International
IR Rectifier

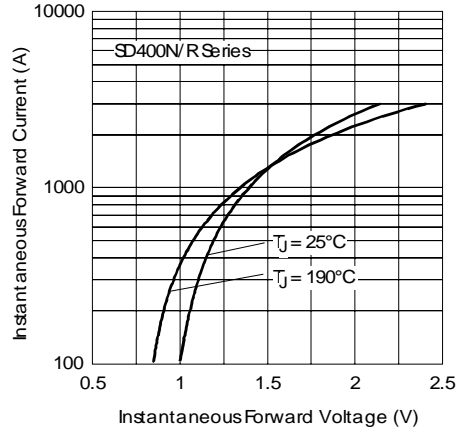

Fig. 7 - Forward Voltage Drop Characteristics

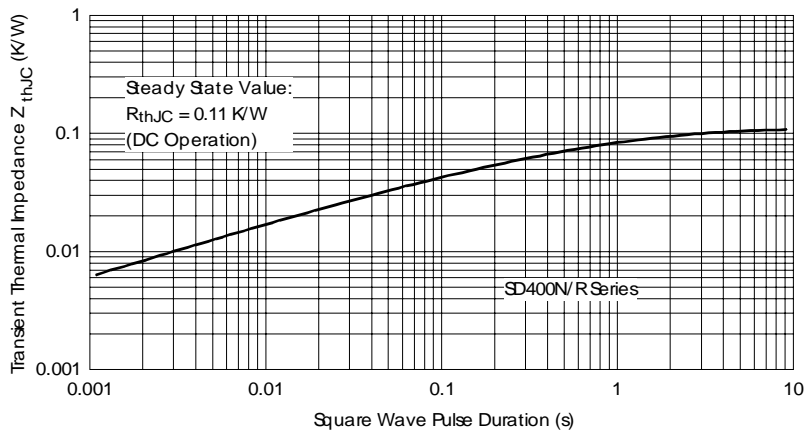

Fig. 8 - Thermal Impedance Z_{thJC} Characteristic

Data and specifications subject to change without notice.
This product has been designed and qualified for Industrial Level.
Qualification Standards can be found on IR's Web site.

International
IR Rectifier

IR WORLD HEADQUARTERS: 233 Kansas St., El Segundo, California 90245, USA Tel: (310) 252-7105
TAC Fax: (310) 252-7309
Visit us at www.irf.com for sales contact information. 03/03