

FAST RECOVERY DIODES

Hockey Puk Version

Features

- High power FAST recovery diode series
- 1.0 to 2.0 μ s recovery time
- High voltage ratings up to 2200V
- High current capability
- Optimized turn on and turn off characteristics
- Low forward recovery
- Fast and soft reverse recovery
- Press-puk encapsulation
- Case style conform to JEDEC B-43
- Maximum junction temperature 125°C

Typical Applications

- Snubber diode for GTO
- High voltage free-wheeling diode
- Fast recovery rectifier applications

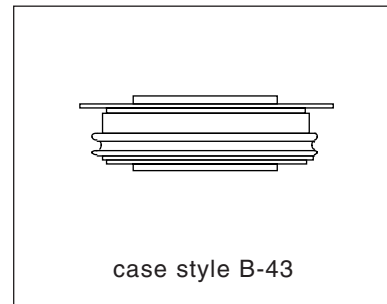
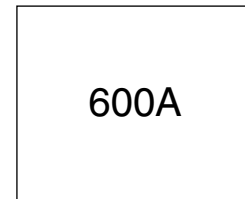

Major Ratings and Characteristics

Parameters	SD603C..C	Units	
$I_{F(AV)}$	600	A	
@ T_{hs}	55	°C	
$I_{F(RMS)}$	942	A	
@ T_{hs}	25	°C	
I_{FSM}	@ 50Hz	8320	A
	@ 60Hz	8715	A
I^2t	@ 50Hz	346	KA ² s
	@ 60Hz	316	KA ² s
V_{RRM} range	400 to 2200	V	
t_{tr} range	1.0 to 2.0	μ s	
@ T_J	25	°C	
T_J	- 40 to 125	°C	

SD603C..C Series

Bulletin I2068 rev.C 04/00

International
IOR Rectifier

ELECTRICAL SPECIFICATIONS

Voltage Ratings

Type number	Voltage Code	V_{RRM} max. repetitive peak and off-state voltage V	V_{RSM} , maximum non-repetitive peak voltage V	I_{RRM} max. $T_J = 125^\circ\text{C}$ mA
SD603C..S10C	04	400	500	45
	08	800	900	
	10	1000	1100	
SD603C..S15C	12	1200	1300	
	14	1400	1500	
	16	1600	1700	
SD603C..S20C	20	2000	2100	
	22	2200	2300	

Forward Conduction

Parameter	SD603C..C	Units	Conditions
$I_{F(AV)}$ Max. average forward current @ Heatsink temperature	600(300)	A	180° conduction, half sine wave.
	55(75)	°C	Double side (single side) cooled
$I_{F(RMS)}$ Max. RMS current	942	A	@ 25°C heatsink temperature double side cooled
I_{FSM} Max. peak, one-cycle non-repetitive forward current	8320	A	t = 10ms No voltage
	8715		t = 8.3ms reapplied
	7000		t = 10ms 100% V_{RRM}
	7330		t = 8.3ms reapplied
I^2t Maximum I^2t for fusing	346	KA ² s	t = 10ms No voltage
	316		t = 8.3ms reapplied
	245		t = 10ms 100% V_{RRM}
	224		t = 8.3ms reapplied
$I^2\sqrt{t}$ Maximum $I^2\sqrt{t}$ for fusing	3460	KA ² √s	t = 0.1 to 10ms, no voltage reapplied
$V_{F(TO)1}$ Low level of threshold voltage	1.36	V	$(16.7\% \times \pi \times I_{F(AV)} < I < \pi \times I_{F(AV)})$, $T_J = T_J$ max.
$V_{F(TO)2}$ High level of threshold voltage	1.81		$(I > \pi \times I_{F(AV)})$, $T_J = T_J$ max.
r_{f1} Low level of forward slope resistance	0.87	mΩ	$(16.7\% \times \pi \times I_{F(AV)} < I < \pi \times I_{F(AV)})$, $T_J = T_J$ max.
r_{f2} High level of forward slope resistance	0.67		$(I > \pi \times I_{F(AV)})$, $T_J = T_J$ max.
V_{FM} Max. forward voltage	2.97	V	$I_{pk} = 1885\text{A}$, $T_J = 25^\circ\text{C}$, $t_p = 10\text{ms}$ sinusoidal wave

Recovery Characteristics

Code	$T_J = 25^\circ\text{C}$ typical t_{rr} @ 25% I_{RRM} (μs)	Test conditions			Max. values @ $T_J = 125^\circ\text{C}$		
		I_{pk} Square Pulse (A)	di/dt (A/μs)	V_r (V)	t_{rr} @ 25% I_{RRM} (μs)	Q_{rr} (μC)	I_{rr} (A)
S10	1.0	1000	25	-30	2.0	45	34
S15	1.5				3.2	87	51
S20	2.0				3.5	97	55

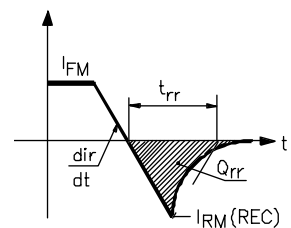

Thermal and Mechanical Specifications

Parameter	SD603C..C	Units	Conditions
T _J Max. operating temperature range	-40 to 125	°C	
T _{stg} Max. storage temperature range	-40 to 150		
R _{thJ-hs} Max. thermal resistance, junction to heatsink	0.076 0.038	K/W	DC operationsingle side cooled DC operationdouble side cooled
F Mounting force, ± 10%	9800 (1000)		N (Kg)
wt Approximate weight	83	g	
Case style	B-43		See Outline Table

ΔR_{thJ-hs} Conduction

(The following table shows the increment of thermal resistance R_{thJ-hs} when devices operate at different conduction angles than DC)

Conduction angle	Sinusoidal conduction		Rectangular conduction		Units	Conditions
	Single Side	Double Side	Single Side	Double Side		
180°	0.006	0.007	0.005	0.005	K/W	T _J = T _J max.
120°	0.008	0.008	0.008	0.008		
90°	0.010	0.010	0.011	0.011		
60°	0.015	0.015	0.016	0.015		
30°	0.026	0.025	0.026	0.025		

Ordering Information Table

Device Code

SD	60	3	C	22	S20	C
①	②	③	④	⑤	⑥	⑦

- 1** - Diode
- 2** - Essential part number
- 3** - 3 = Fast recovery
- 4** - C = Ceramic Puk
- 5** - Voltage code: Code x 100 = V_{RRM} (see Voltage Ratings table)
- 6** - t_{rr} code (see Recovery Characteristics table)
- 7** - C = Puk Case B-43

SD603C..C Series

Bulletin I2068 rev. C 04/00

Outline Table

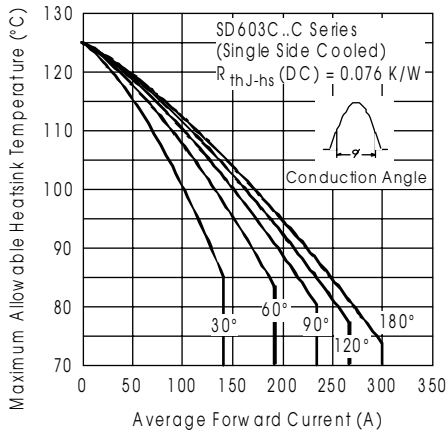
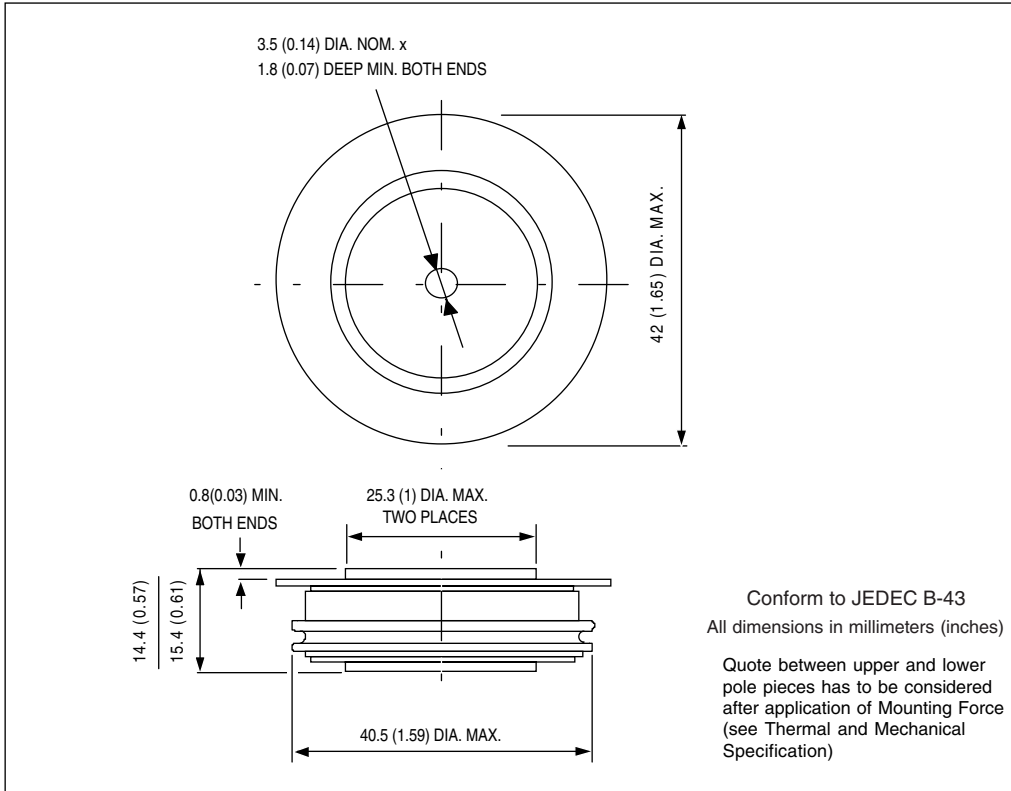

Fig. 1 - Current Ratings Characteristics

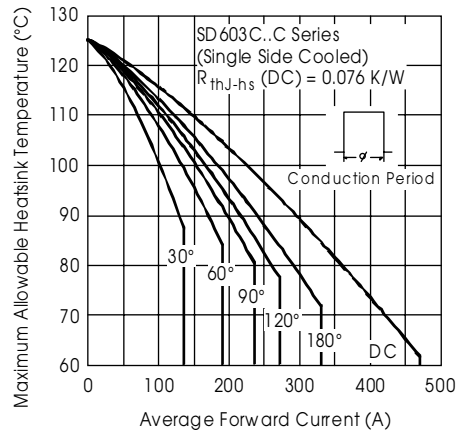

Fig. 2 - Current Ratings Characteristics

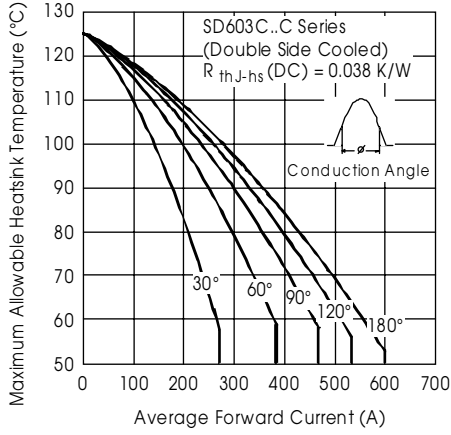

Fig. 3 - Current Ratings Characteristics

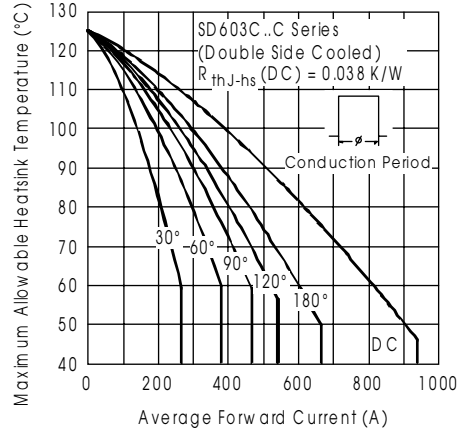

Fig. 4 - Current Ratings Characteristics

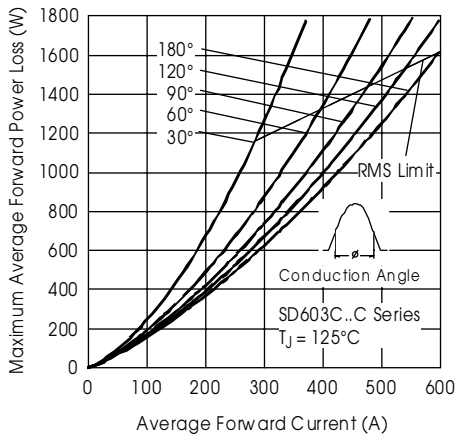

Fig. 5 - Forward Power Loss Characteristics

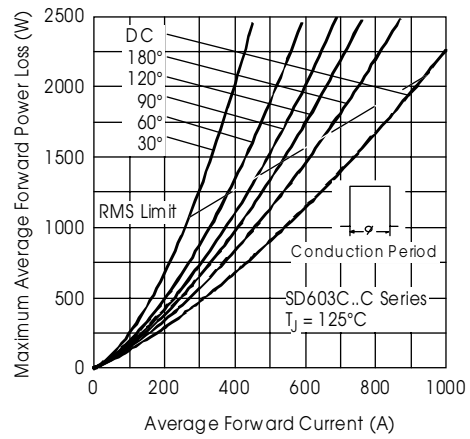

Fig. 6 - Forward Power Loss Characteristics

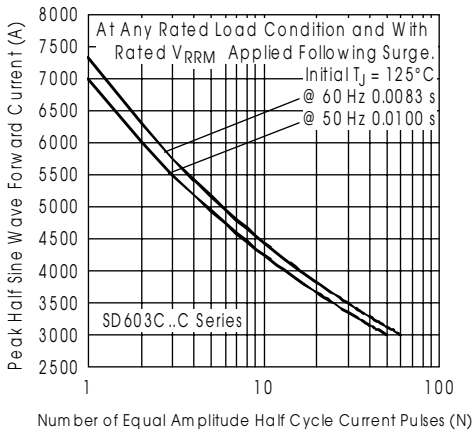

Fig. 7 - Maximum Non-repetitive Surge Current Single and Double Side Cooled

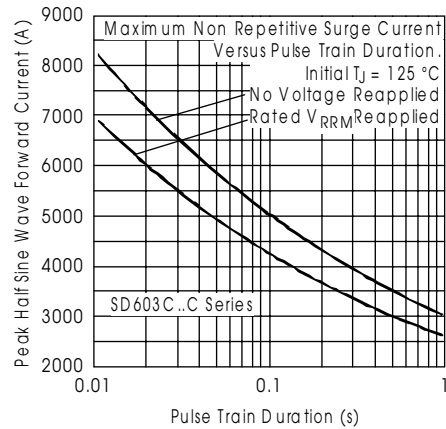

Fig. 8 - Maximum Non-repetitive Surge Current Single and Double Side Cooled

SD603C..C Series

Bulletin I2068 rev. C 04/00

International
IR Rectifier

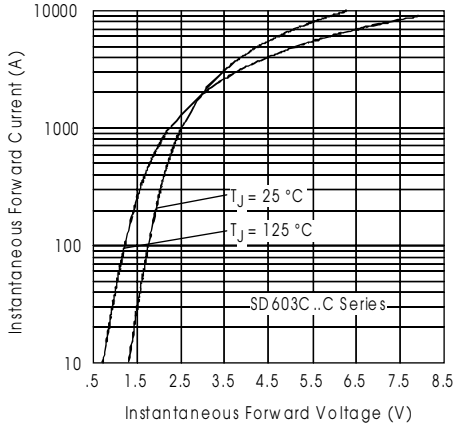

Fig. 9 - Forward Voltage Drop Characteristics

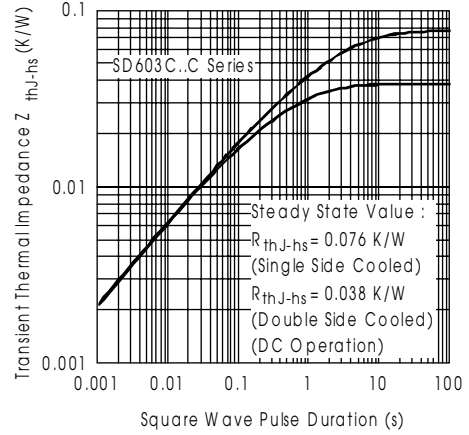

Fig. 10 - Thermal Impedance Z_{thJ-hs} Characteristic

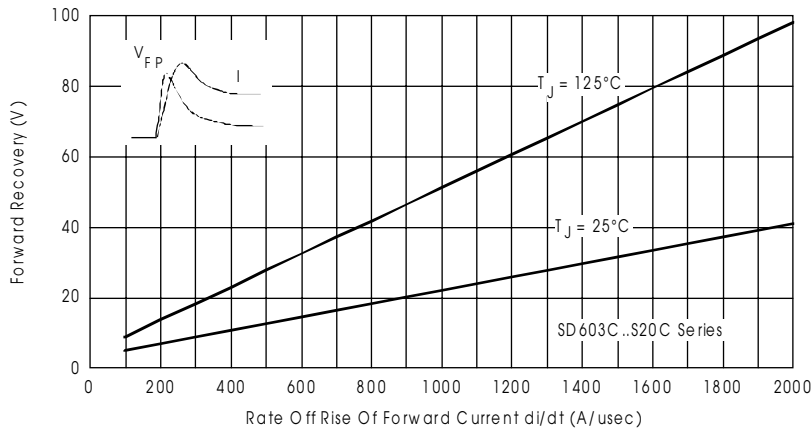

Fig. 11 - Typical Forward Recovery Characteristics

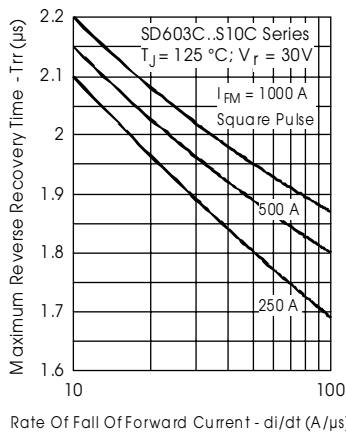

Fig. 12 - Recovery Time Characteristics

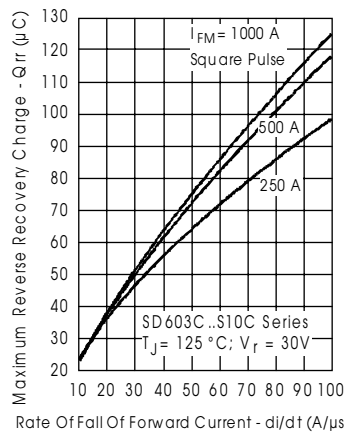

Fig. 13 - Recovery Charge Characteristics

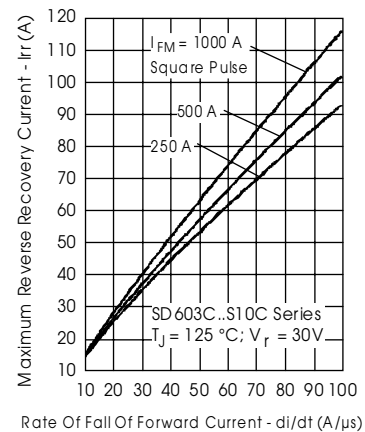

Fig. 14 - Recovery Current Characteristics

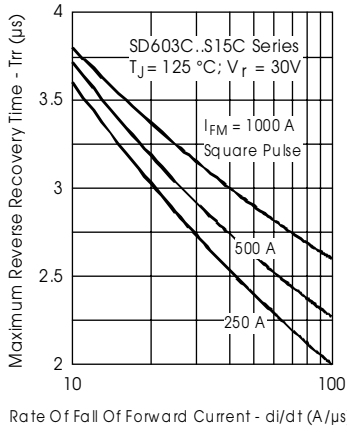

Fig. 15 - Recovery Time Characteristics

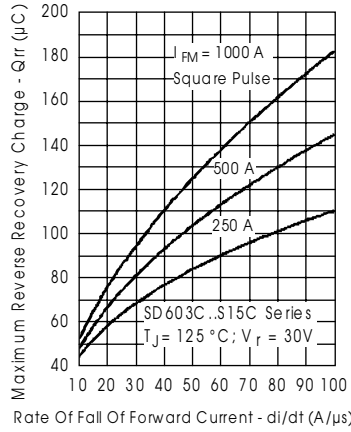

Fig. 16 - Recovery Charge Characteristics

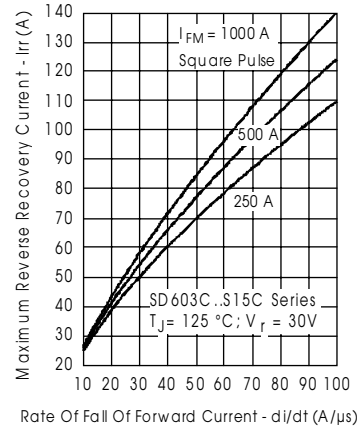

Fig. 17 - Recovery Current Characteristics

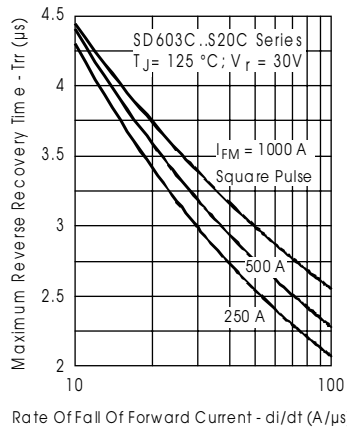

Fig. 18 - Recovery Time Characteristics

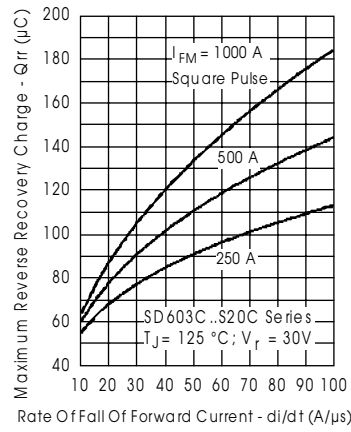

Fig. 19 - Recovery Charge Characteristics

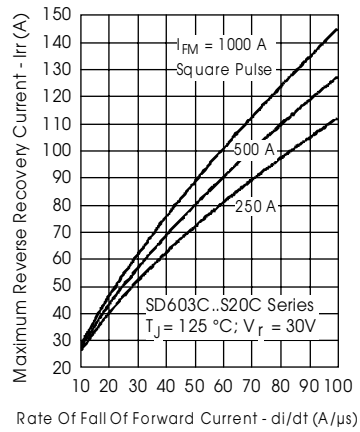

Fig. 20 - Recovery Current Characteristics

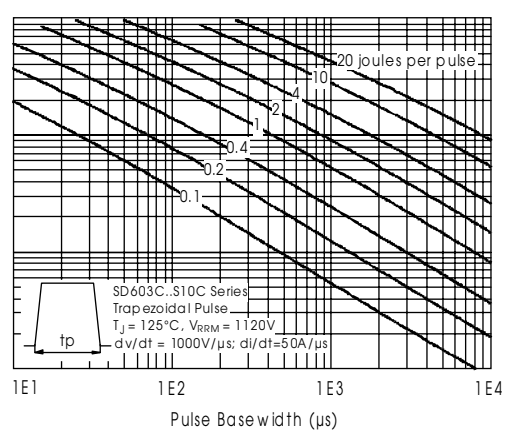
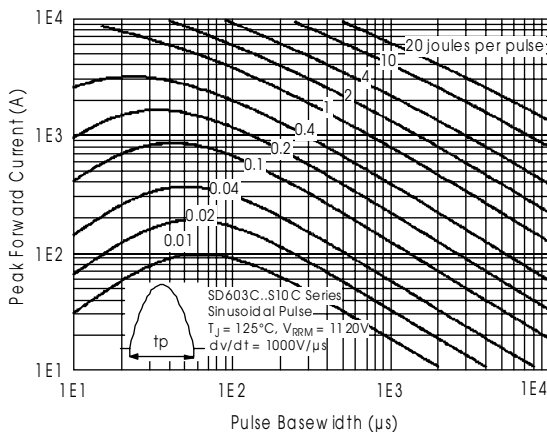

Fig. 21 - Maximum Total Energy Loss Per Pulse Characteristics

SD603C..C Series

Bulletin I2068 rev. C 04/00

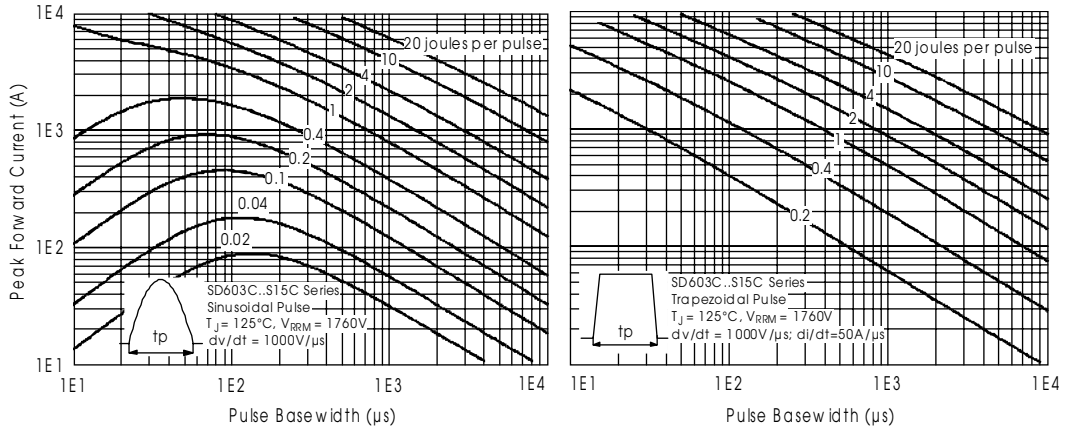

Fig. 22 - Maximum Total Energy Loss Per Pulse Characteristics

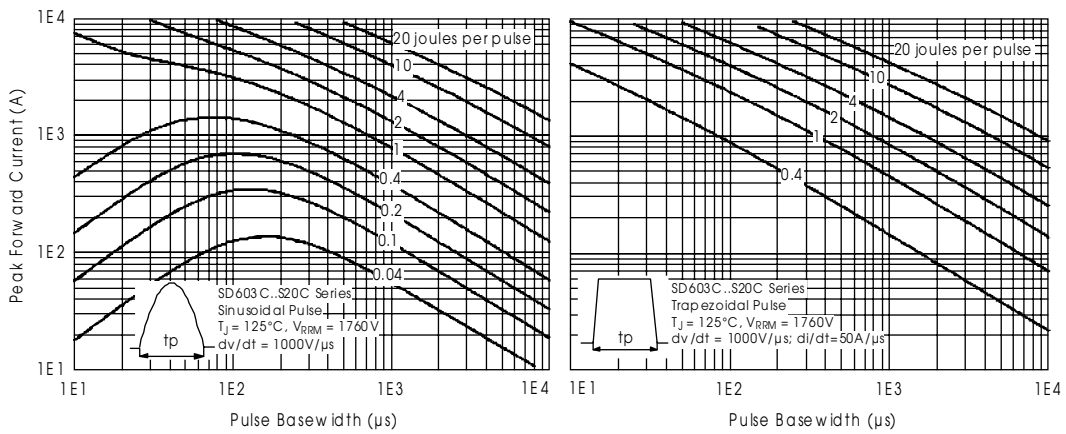

Fig. 23 - Maximum Total Energy Loss Per Pulse Characteristics