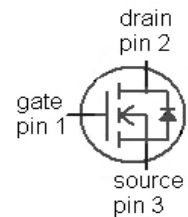
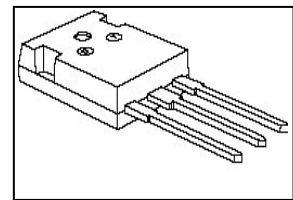

**CoolMOS™ Power Transistor**
**Features**

- New revolutionary high voltage technology
- Ultra low gate charge
- Periodic avalanche rated
- Extreme  $dv/dt$  rated
- Ultra low effective capacitances
- Improved transconductance

**Product Summary**

$V_{DS} @ T_{j,max}$	650	V
$R_{DS(on),max}$	0.1	$\Omega$
$I_D$	34.6	A

**P-TO247**

Type	Package	Ordering Code	Marking
SPW35N60C3	P-TO247	Q67040-S4673	35N60C3

**Maximum ratings, at  $T_j=25\text{ }^\circ\text{C}$ , unless otherwise specified**

Parameter	Symbol	Conditions	Value	Unit
Continuous drain current	$I_D$	$T_C=25\text{ }^\circ\text{C}$	34.6	A
		$T_C=100\text{ }^\circ\text{C}$	21.9	
Pulsed drain current <sup>1)</sup>	$I_{D,pulse}$	$T_C=25\text{ }^\circ\text{C}$	103.8	
Avalanche energy, single pulse	$E_{AS}$	$I_D=17.3\text{ A}$ , $V_{DD}=50\text{ V}$	1500	mJ
Avalanche energy, repetitive $t_{AR}$ <sup>1),2)</sup>	$E_{AR}$	$I_D=34.6\text{ A}$ , $V_{DD}=50\text{ V}$	1.5	
Avalanche current, repetitive $t_{AR}$ <sup>1)</sup>	$I_{AR}$		34.6	A
Drain source voltage slope	$dv/dt$	$I_D=34.6\text{ A}$ , $V_{DS}=480\text{ V}$ , $T_j=125\text{ }^\circ\text{C}$	50	V/ns
Gate source voltage	$V_{GS}$	static	$\pm 20$	V
	$V_{GS}$	AC ( $f > 1\text{ Hz}$ )	$\pm 30$	
Power dissipation	$P_{tot}$	$T_C=25\text{ }^\circ\text{C}$	313	W
Operating and storage temperature	$T_j$ , $T_{stg}$		-55 ... 150	$^\circ\text{C}$

Parameter	Symbol	Conditions	Values			Unit
			min.	typ.	max.	
<b>Thermal characteristics</b>						
Thermal resistance, junction - case	$R_{thJC}$		-	-	0.4	K/W
Thermal resistance, junction - ambient	$R_{thJA}$	leaded	-	-	62	
Soldering temperature	$T_{sold}$	1.6 mm (0.063 in.) from case for 10 s	-	-	260	°C

**Electrical characteristics, at  $T_j=25\text{ °C}$ , unless otherwise specified**

**Static characteristics**

Drain-source breakdown voltage	$V_{(BR)DSS}$	$V_{GS}=0\text{ V}, I_D=250\text{ }\mu\text{A}$	600	-	-	V
Avalanche breakdown voltage	$V_{(BR)DS}$	$V_{GS}=0\text{ V}, I_D=34.6\text{ A}$	-	700	-	
Gate threshold voltage	$V_{GS(th)}$	$V_{DS}=V_{GS}, I_D=1.9\text{ mA}$	2.1	3	3.9	
Zero gate voltage drain current	$I_{DSS}$	$V_{DS}=600\text{ V}, V_{GS}=0\text{ V}, T_j=25\text{ °C}$	-	0.1	1	$\mu\text{A}$
		$V_{DS}=600\text{ V}, V_{GS}=0\text{ V}, T_j=150\text{ °C}$	-	-	100	
Gate-source leakage current	$I_{GSS}$	$V_{GS}=20\text{ V}, V_{DS}=0\text{ V}$	-	-	100	nA
Drain-source on-state resistance	$R_{DS(on)}$	$V_{GS}=10\text{ V}, I_D=21.9\text{ A}, T_j=25\text{ °C}$	-	0.081	0.1	$\Omega$
		$V_{GS}=10\text{ V}, I_D=21.9\text{ A}, T_j=150\text{ °C}$	-	0.2	-	
Gate resistance	$R_G$	$f=1\text{ MHz}$ , open drain	-	0.6	-	
Transconductance	$g_{fs}$	$ V_{DS} >2 I_D R_{DS(on)max}, I_D=21.9\text{ A}$	-	36	-	S

Parameter	Symbol	Conditions	Values			Unit
			min.	typ.	max.	

**Dynamic characteristics**

Input capacitance	$C_{iss}$	$V_{GS}=0\text{ V}, V_{DS}=25\text{ V}, f=1\text{ MHz}$	-	4500	-	pF
Output capacitance	$C_{oss}$		-	1500	-	
Reverse transfer capacitance	$C_{rss}$		-	100	-	
Effective output capacitance, energy related <sup>3)</sup>	$C_{o(er)}$	$V_{GS}=0\text{ V}, V_{DS}=0\text{ V}$ to 480 V	-	180	-	ns
Effective output capacitance, time related <sup>4)</sup>	$C_{o(tr)}$		-	324	-	
Turn-on delay time	$t_{d(on)}$	$V_{DD}=480\text{ V}, V_{GS}=10\text{ V}, I_D=34.6\text{ A}, R_G=3.3\ \Omega$	-	10	-	
Rise time	$t_r$		-	5	-	
Turn-off delay time	$t_{d(off)}$		-	70	-	
Fall time	$t_f$		-	10	-	

**Gate Charge Characteristics**

Gate to source charge	$Q_{gs}$	$V_{DD}=480\text{ V}, I_D=34.6\text{ A}, V_{GS}=0\text{ to }10\text{ V}$	-	18	-	nC
Gate to drain charge	$Q_{gd}$		-	70	-	
Gate charge total	$Q_g$		-	150	200	
Gate plateau voltage	$V_{plateau}$		-	5.3	-	V

<sup>1)</sup> Pulse width limited by maximum temperature  $T_{j,max}$  only

<sup>2)</sup> Repetitive avalanche causes additional power losses that can be calculated as  $P_{AV}=E_{AR} \cdot f$ .

<sup>3)</sup>  $C_{o(er)}$  is a fixed capacitance that gives the same stored energy as  $C_{oss}$  while  $V_{DS}$  is rising from 0 to 80%  $V_{DSS}$ .

<sup>4)</sup>  $C_{o(tr)}$  is a fixed capacitance that gives the same charging time as  $C_{oss}$  while  $V_{DS}$  is rising from 0 to 80%  $V_{DSS}$ .

Parameter	Symbol	Conditions	Values			Unit
			min.	typ.	max.	

**Reverse Diode**

Diode continuous forward current	$I_S$	$T_C=25\text{ }^\circ\text{C}$	-	-	34.6	A
Diode pulse current	$I_{S,pulse}$		-	-	103.8	
Diode forward voltage	$V_{SD}$	$V_{GS}=0\text{ V}, I_F=34.6\text{ A}, T_j=25\text{ }^\circ\text{C}$	-	0.95	1.2	V
Reverse recovery time	$t_{rr}$	$V_R=480\text{ V}, I_F=I_S, di_F/dt=100\text{ A}/\mu\text{s}$	-	600	-	ns
Reverse recovery charge	$Q_{rr}$		-	21	-	$\mu\text{C}$
Peak reverse recovery current	$I_{rrm}$		-	90	-	A

**Typical Transient Thermal Characteristics**

Symbol	Value	Unit	Symbol	Value	Unit
	typ.			typ.	
$R_{th1}$	0.00441	K/W	$C_{th1}$	0.00037	Ws/K
$R_{th2}$	0.00608		$C_{th2}$	0.00223	
$R_{th3}$	0.0341		$C_{th3}$	0.00315	
$R_{th4}$	0.0602		$C_{th4}$	0.0179	
$R_{th5}$	0.0884		$C_{th5}$	0.098	
			$C_{th6}$	4.4 <sup>5)</sup>	

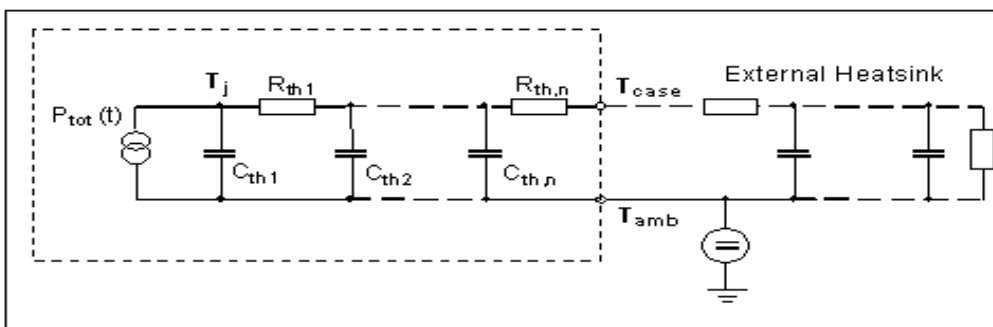

<sup>5)</sup>  $C_{th6}$  models the additional heat capacitance of the package in case of non-ideal cooling. It is not needed if  $R_{thCA}=0\text{ K/W}$ .

**1 Power dissipation**

$P_{tot}=f(T_C)$

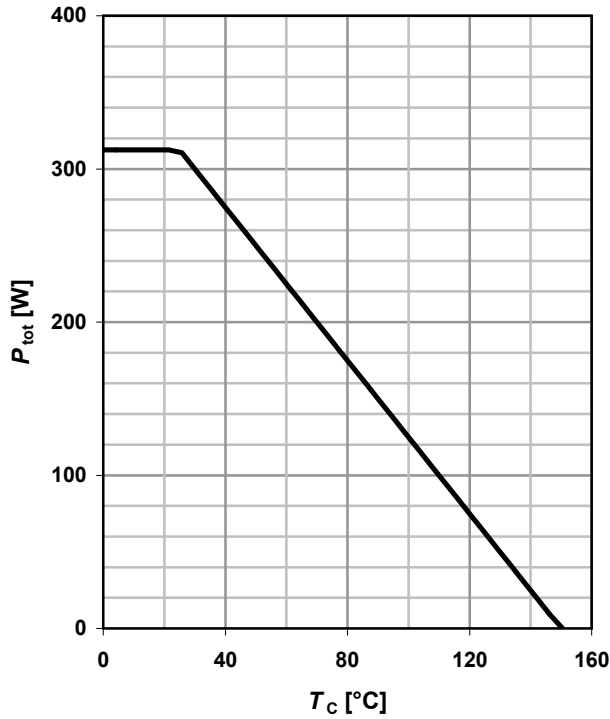

**2 Safe operating area**

$I_D=f(V_{DS}); T_C=25\text{ }^\circ\text{C}; D=0$

parameter:  $t_p$

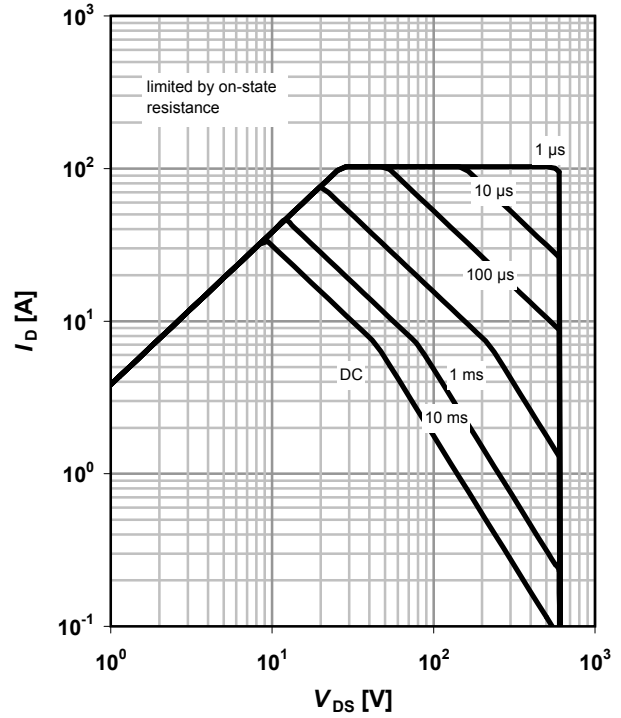

**3 Max. transient thermal impedance**

$I_D=f(V_{DS}); T_j=25\text{ }^\circ\text{C}$

parameter:  $D=t_p/T$

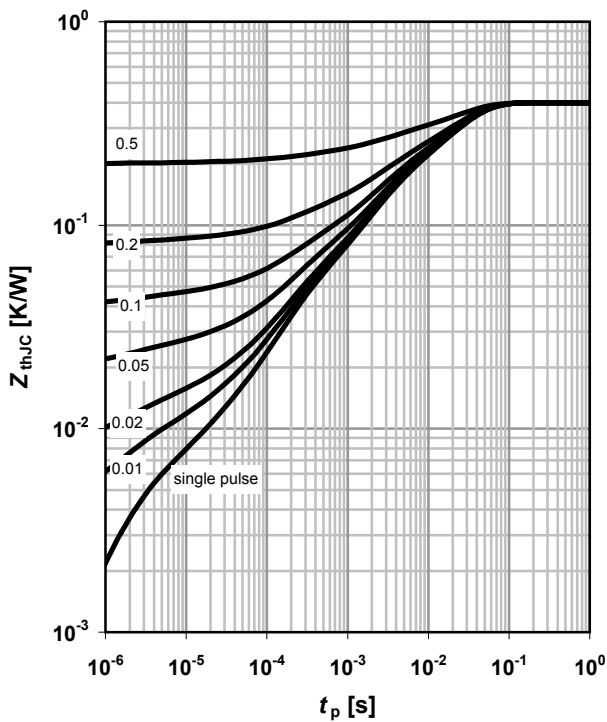

**4 Typ. output characteristics**

$I_D=f(V_{DS}); T_j=25\text{ }^\circ\text{C}$

parameter:  $V_{GS}$

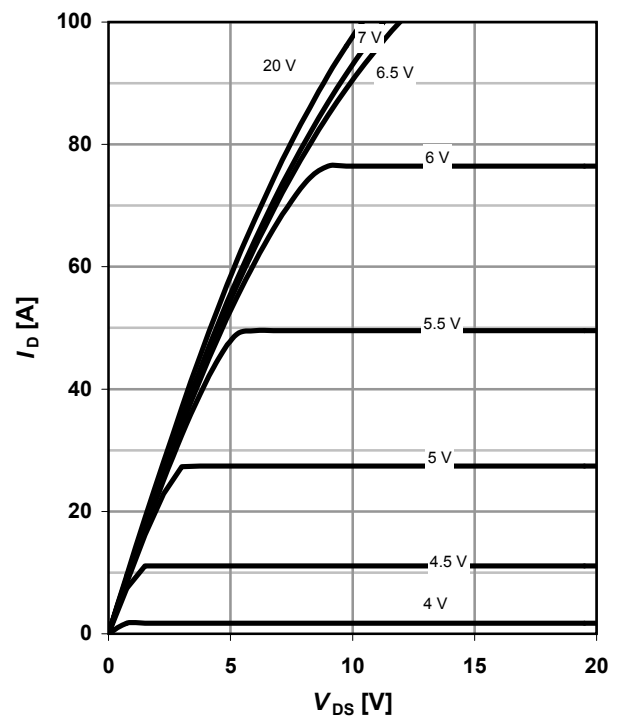

**5 Typ. output characteristics**

$I_D = f(V_{DS}); T_j = 150\text{ }^\circ\text{C}$

parameter:  $V_{GS}$

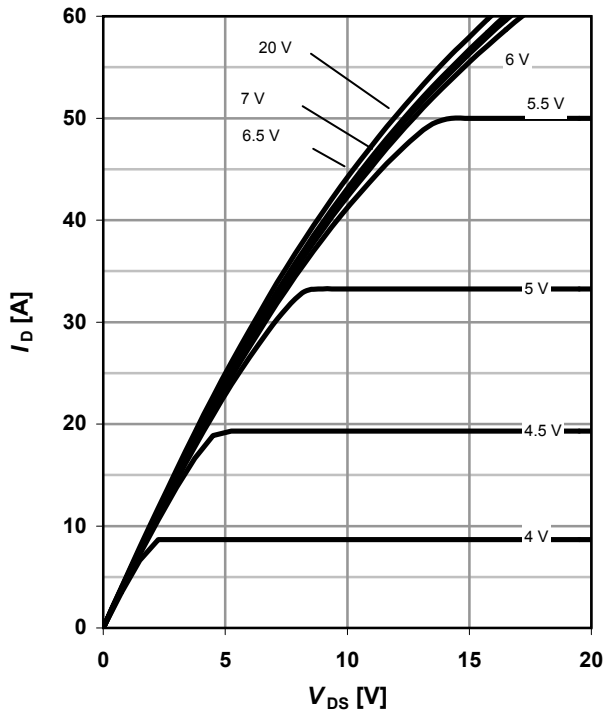

**6 Typ. drain-source on-state resistance**

$R_{DS(on)} = f(I_D); T_j = 150\text{ }^\circ\text{C}$

parameter:  $V_{GS}$

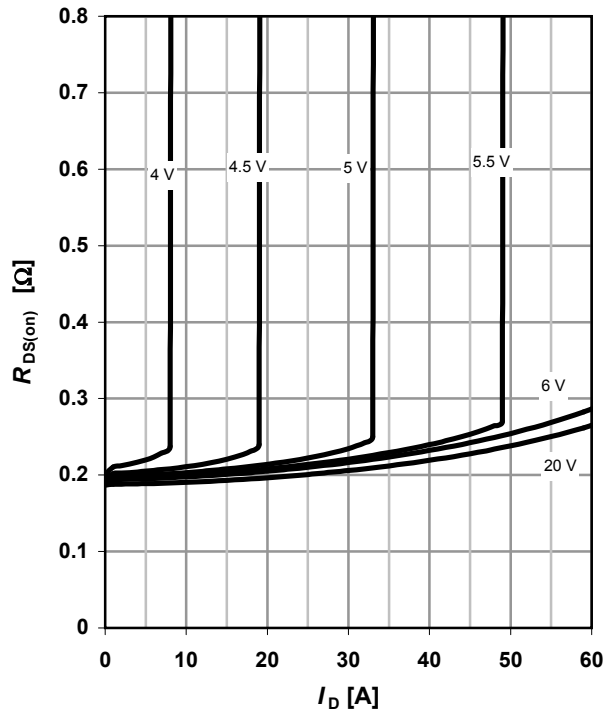

**7 Drain-source on-state resistance**

$R_{DS(on)} = f(T_j); I_D = 21.9\text{ A}; V_{GS} = 10\text{ V}$

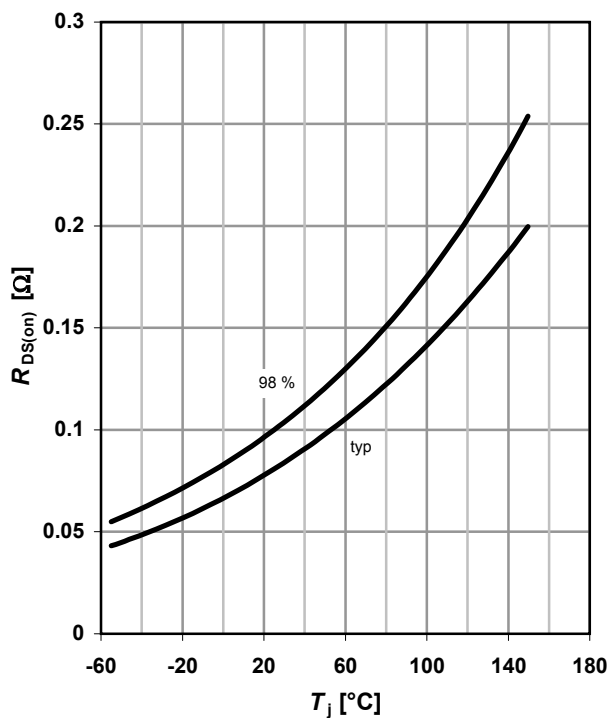

**8 Typ. transfer characteristics**

$I_D = f(V_{GS}); |V_{DS}| > 2|I_D|R_{DS(on)max}$

parameter:  $T_j$

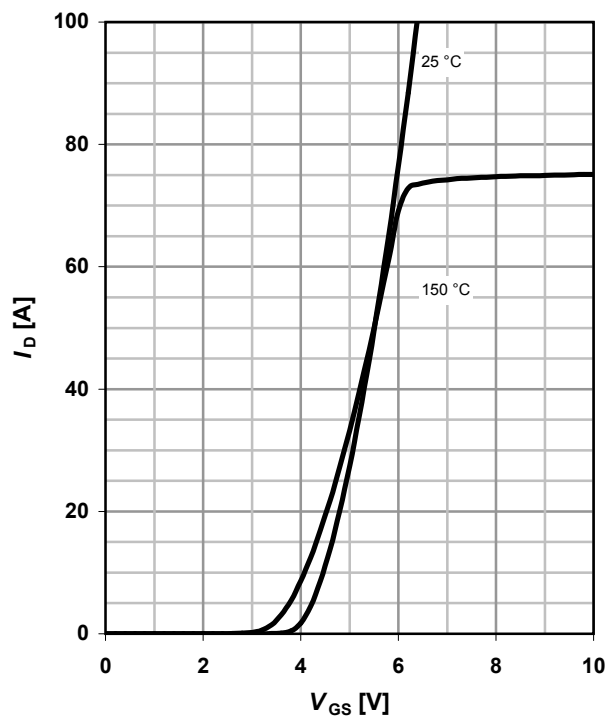

**9 Typ. gate charge**

$V_{GS}=f(Q_{gate}); I_D=34.6 \text{ A pulsed}$

parameter:  $V_{DD}$

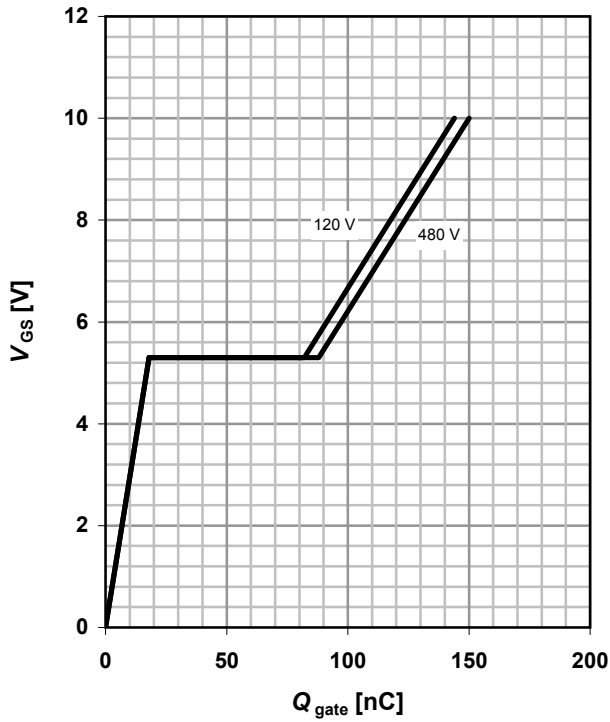

**10 Forward characteristics of reverse diode**

$I_F=f(V_{SD})$

parameter:  $T_j$

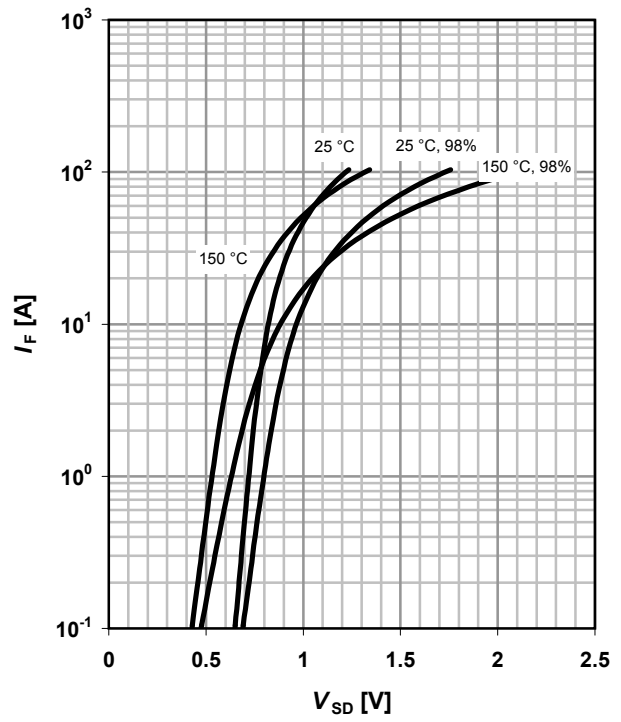

**11 Avalanche SOA**

$I_{AR}=f(t_{AR})$

parameter:  $T_{j(start)}$

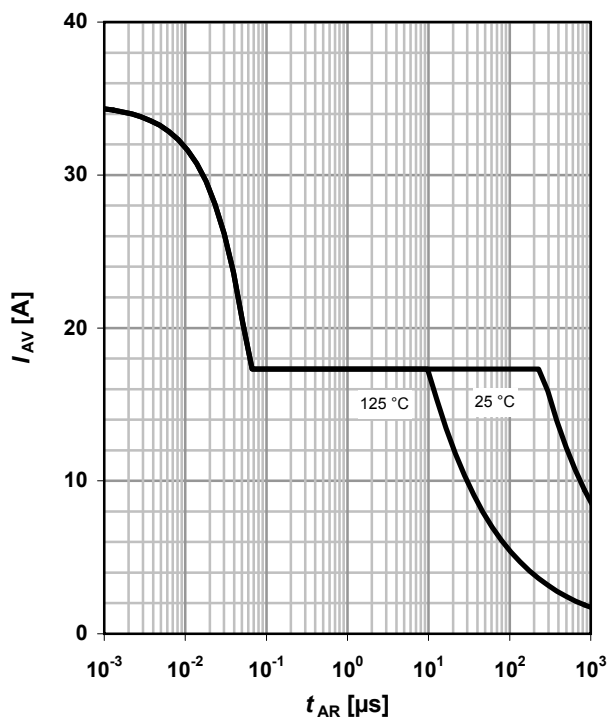

**12 Avalanche energy**

$E_{AS}=f(T_j); I_D=17.3 \text{ A}; V_{DD}=50 \text{ V}$

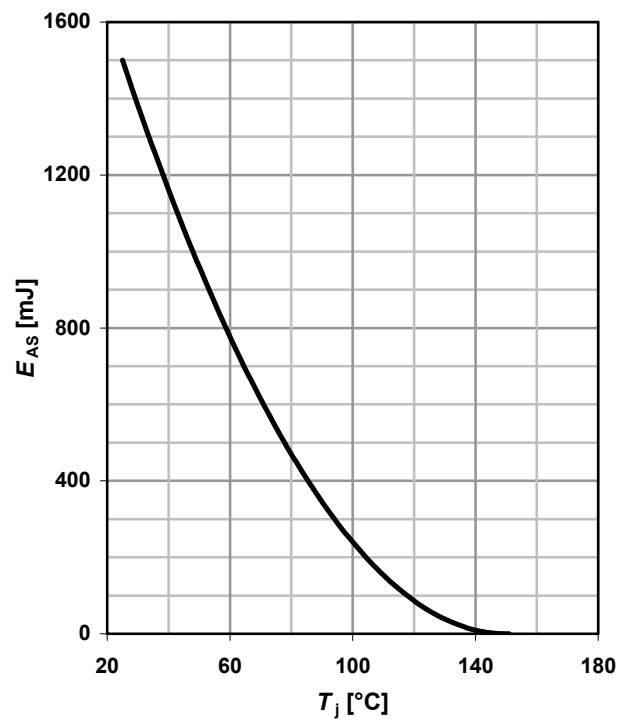

**13 Drain-source breakdown voltage**

$$V_{BR(DSS)} = f(T_j); I_D = 0.25 \text{ mA}$$

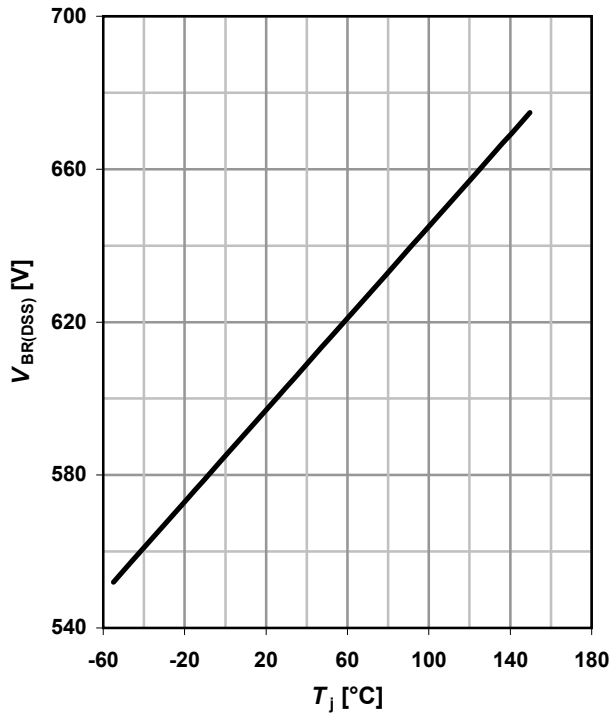

**14 Typ. capacitances**

$$C = f(V_{DS}); V_{GS} = 0 \text{ V}; f = 1 \text{ MHz}$$

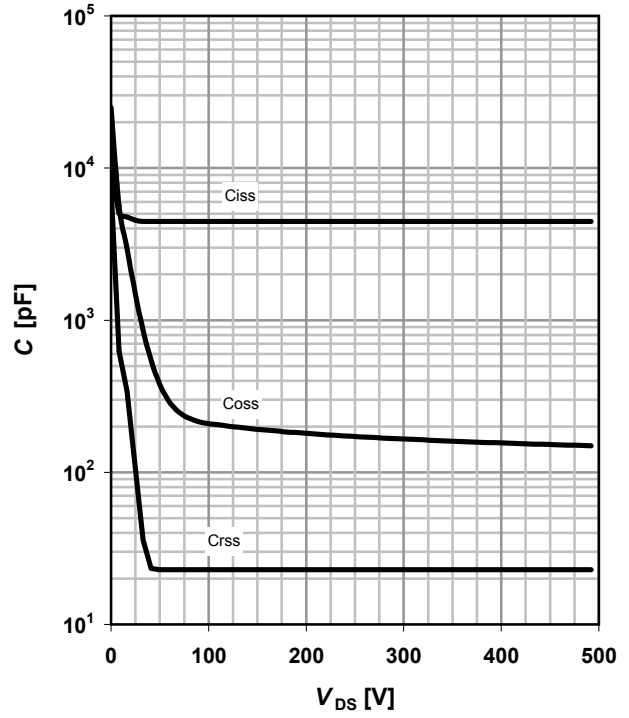

**15 Typ.  $C_{oss}$  stored energy**

$$E_{oss} = f(V_{DS})$$

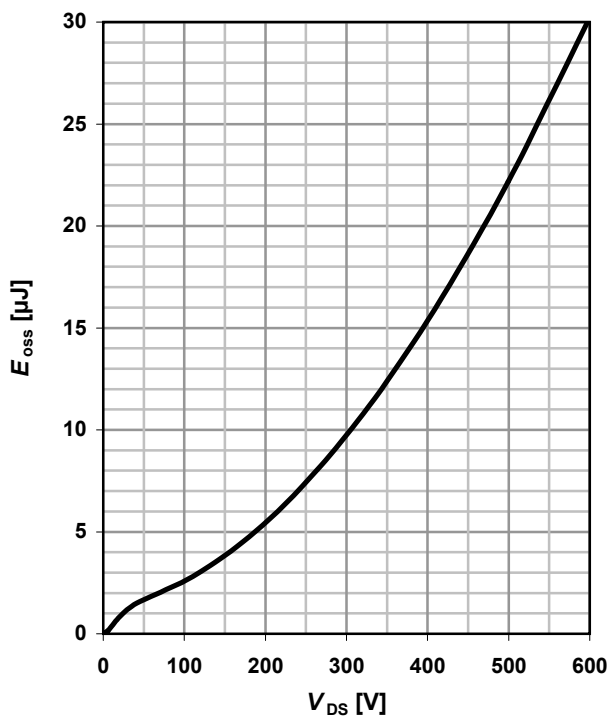



Definition of diode switching characteristics

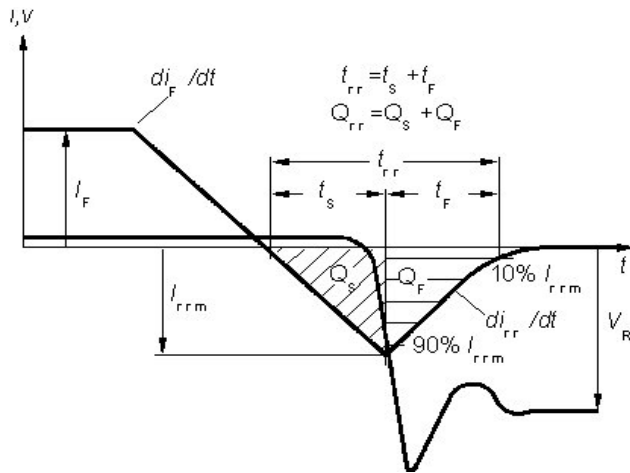

P-TO247: Outline

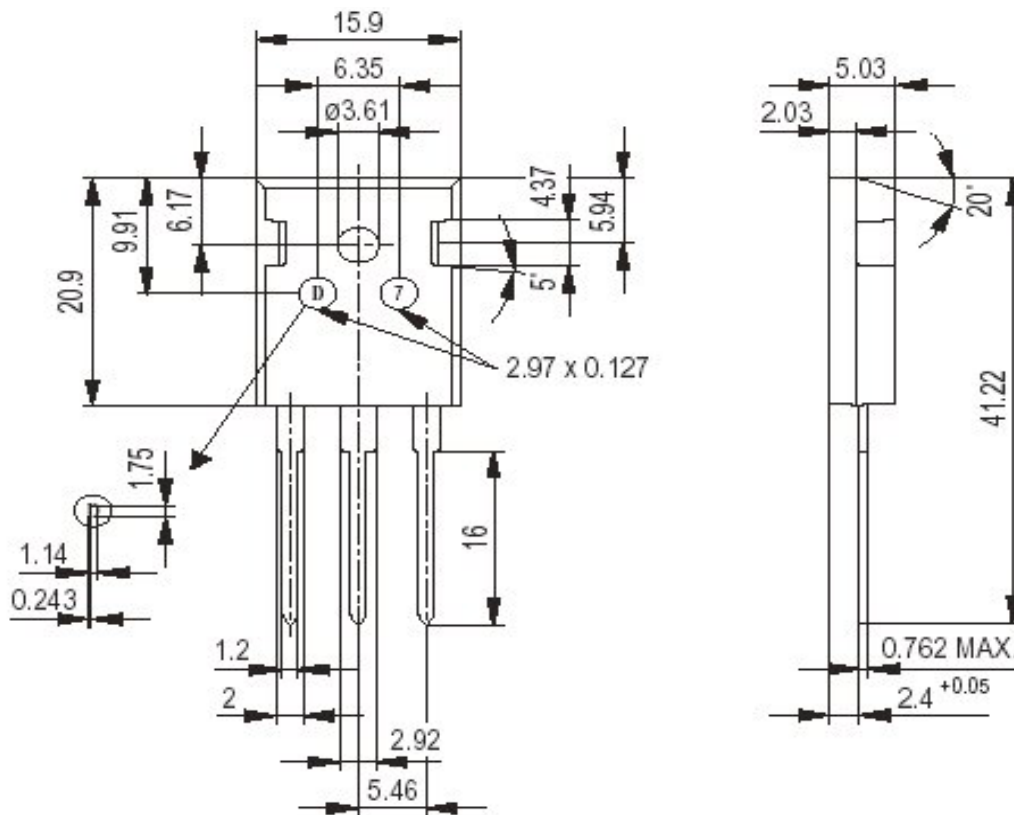

General tolerance unless otherwise specified: Leadframe parts:  $\pm 0.05$   
 Package parts:  $\pm 0.12$

Dimensions in mm

**Published by**  
**Infineon Technologies AG**  
**Bereich Kommunikation**  
**St.-Martin-Straße 53**  
**D-81541 München**  
**© Infineon Technologies AG 1999**  
**All Rights Reserved.**

**Attention please!**

The information herein is given to describe certain components and shall not be considered as warranted characteristics.

Terms of delivery and rights to technical change reserved.

We hereby disclaim any and all warranties, including but not limited to warranties of non-infringement, regarding circuits, descriptions and charts stated herein.

Infineon Technologies is an approved CECC manufacturer.

**Information**

For further information on technology, delivery terms and conditions and prices, please contact your nearest Infineon Technologies office in Germany or our Infineon Technologies representatives worldwide (see address list).

**Warnings**

Due to technical requirements, components may contain dangerous substances.  
For information on the types in question, please contact your nearest Infineon Technologies office.

Infineon Technologies' components may only be used in life-support devices or systems with the expressed written approval of Infineon Technologies if a failure of such components can reasonably be expected to cause the failure of that life-support device or system, or to affect the safety or effectiveness of that device or system. Life support devices or systems are intended to be implanted in the human body, or to support and/or maintain and sustain and/or protect human life. If they fail, it is reasonable to assume that the health of the user or other persons may be endangered.