

PHASE CONTROL THYRISTORS

Hockey Puk Version

Features

- Center amplifying gate
- Metal case with ceramic insulator
- International standard case TO-200AB (A-PUK)

Typical Applications

- DC motor controls
- Controlled DC power supplies
- AC controllers

Major Ratings and Characteristics

Parameters	ST180C..C	Units	
$I_{T(AV)}$	350	A	
@ T_{hs}	55	°C	
$I_{T(RMS)}$	660	A	
@ T_{hs}	25	°C	
I_{TSM}	@ 50Hz	5000	A
	@ 60Hz	5230	A
I^2t	@ 50Hz	125	KA ² s
	@ 60Hz	114	KA ² s
V_{DRM}/V_{RRM}	400 to 2000	V	
t_q typical	100	μs	
T_J	- 40 to 125	°C	

350A

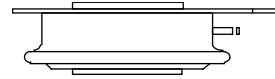

case style TO-200AB (A-PUK)

ST180C..C Series

Bulletin I25164 rev. C 02/00

International
IRF Rectifier

ELECTRICAL SPECIFICATIONS

Voltage Ratings

Type number	Voltage Code	V_{DRM}/V_{RRM} , max. repetitive peak and off-state voltage V	V_{RSM} , maximum non-repetitive peak voltage V	I_{DRM}/I_{RRM} max. @ $T_J = T_J$ max mA
ST180C..C	04	400	500	30
	08	800	900	
	12	1200	1300	
	16	1600	1700	
	18	1800	1900	
	20	2000	2100	

On-state Conduction

Parameter	ST180C..C	Units	Conditions	
$I_{T(AV)}$ Max. average on-state current @ Heatsink temperature	350 (140)	A	180° conduction, half sine wave double side (single side) cooled	
	55 (85)	°C		
$I_{T(RMS)}$ Max. RMS on-state current	660	A	@ 25°C heatsink temperature double side cooled	
I_{TSM} Max. peak, one-cycle non-repetitive surge current	5000		t = 10ms	No voltage
	5230		t = 8.3ms	reapplied
	4200		t = 10ms	100% V_{RRM}
	4400	t = 8.3ms	reapplied	
I^2t Maximum I^2t for fusing	125	KA ² s	t = 10ms	Sinusoidal half wave, Initial $T_J = T_J$ max.
	114		t = 8.3ms	
	88		t = 10ms	
	81		t = 8.3ms	
$I^2\sqrt{t}$ Maximum $I^2\sqrt{t}$ for fusing	1250	KA ² /s	t = 0.1 to 10ms, no voltage reapplied	
$V_{T(TO)1}$ Low level value of threshold voltage	1.08	V	$(16.7\% \times \pi \times I_{T(AV)} < I < \pi \times I_{T(AV)})$, $T_J = T_J$ max.	
$V_{T(TO)2}$ High level value of threshold voltage	1.14		$(I > \pi \times I_{T(AV)})$, $T_J = T_J$ max.	
r_{t1} Low level value of on-state slope resistance	1.18	mΩ	$(16.7\% \times \pi \times I_{T(AV)} < I < \pi \times I_{T(AV)})$, $T_J = T_J$ max.	
r_{t2} High level value of on-state slope resistance	1.14		$(I > \pi \times I_{T(AV)})$, $T_J = T_J$ max.	
V_{TM} Max. on-state voltage	1.96	V	$I_{pk} = 750A$, $T_J = T_J$ max, $t_p = 10ms$ sine pulse	
I_H Maximum holding current	600	mA	$T_J = T_J$ max, anode supply 12V resistive load	
I_L Max. (typical) latching current	1000 (300)			

Switching

Parameter	ST180C..C	Units	Conditions
di/dt Max. non-repetitive rate of rise of turned-on current	1000	A/μs	Gate drive 20V, 20Ω, t _r ≤ 1 μs T _J = T _J max, anode voltage ≤ 80% V _{DRM}
t _d Typical delay time	1.0	μs	Gate current 1A, di _g /dt = 1A/μs V _d = 0.67% V _{DRM} , T _J = 25°C
t _q Typical turn-off time	100		I _{TM} = 300A, T _J = T _J max, di/dt = 20A/μs, V _R = 50V dv/dt = 20V/μs, Gate 0V 100Ω, t _p = 500μs

Blocking

Parameter	ST180C..C	Units	Conditions
dv/dt Maximum critical rate of rise of off-state voltage	500	V/μs	T _J = T _J max linear to 80% rated V _{DRM}
I _{DRM} I _{RRM} Max. peak reverse and off-state leakage current	30	mA	T _J = T _J max, rated V _{DRM} /V _{RRM} applied

Triggering

Parameter	ST180C..C		Units	Conditions
P _{GM} Maximum peak gate power	10		W	T _J = T _J max, t _p ≤ 5ms
P _{G(AV)} Maximum average gate power	2.0			T _J = T _J max, f = 50Hz, d% = 50
I _{GM} Max. peak positive gate current	3.0		A	T _J = T _J max, t _p ≤ 5ms
+V _{GM} Maximum peak positive gate voltage	20		V	T _J = T _J max, t _p ≤ 5ms
-V _{GM} Maximum peak negative gate voltage	5.0			
I _{GT} DC gate current required to trigger	TYP.	MAX.	mA	T _J = - 40°C T _J = 25°C T _J = 125°C Max. required gate trigger/ current/ voltage are the lowest value which will trigger all units 12V anode-to-cathode applied
	180	-		
	90	150		
V _{GT} DC gate voltage required to trigger	2.9	-	V	T _J = - 40°C T _J = 25°C T _J = 125°C
	1.8	3.0		
	1.2	-		
I _{GD} DC gate current not to trigger	10		mA	T _J = T _J max Max. gate current/voltage not to trigger is the max. value which will not trigger any unit with rated V _{DRM} anode-to-cathode applied
V _{GD} DC gate voltage not to trigger	0.25			

ST180C..C Series

Bulletin I25164 rev. C 02/00

International
IRF Rectifier

Thermal and Mechanical Specification

Parameter	ST180C..C	Units	Conditions
T _J Max. operating temperature range	-40 to 125	°C	
T _{stg} Max. storage temperature range	-40 to 150		
R _{thJ-hs} Max. thermal resistance, junction to heatsink	0.17 0.08	K/W	DC operation single side cooled DC operation double side cooled
R _{thC-hs} Max. thermal resistance, case to heatsink	0.033 0.017		K/W
F Mounting force, ± 10%	4900 (500)	N (Kg)	
wt Approximate weight	50	g	
Case style	TO - 200AB (A-PUK)		See Outline Table

ΔR_{thJ-hs} Conduction

(The following table shows the increment of thermal resistance R_{thJ-hs} when devices operate at different conduction angles than DC)

Conduction angle	Sinusoidal conduction		Rectangular conduction		Units	Conditions
	Single Side	Double Side	Single Side	Double Side		
180°	0.015	0.015	0.011	0.011	K/W	T _J = T _J max.
120°	0.018	0.019	0.019	0.019		
90°	0.024	0.024	0.026	0.026		
60°	0.035	0.035	0.036	0.037		
30°	0.060	0.060	0.060	0.061		

Ordering Information Table

Device Code							
ST	18	0	C	20	C	1	
①	②	③	④	⑤	⑥	⑦	⑧
1	- Thyristor	2	- Essential part number	3	- 0 = Converter grade	4	- C = Ceramic Puk
5	- Voltage code: Code x 100 = V _{RRM} (See Voltage Rating Table)	6	- C = Puk Case TO-200AB (A-PUK)	7	- 0 = Eyelet terminals (Gate and Auxiliary Cathode Unsoldered Leads) 1 = Fast-on terminals (Gate and Auxiliary Cathode Unsoldered Leads) 2 = Eyelet terminals (Gate and Auxiliary Cathode Soldered Leads) 3 = Fast-on terminals (Gate and Auxiliary Cathode Soldered Leads)	8	- Critical dv/dt: None = 500V/μsec (Standard value) L = 1000V/μsec (Special selection)

Outline Table

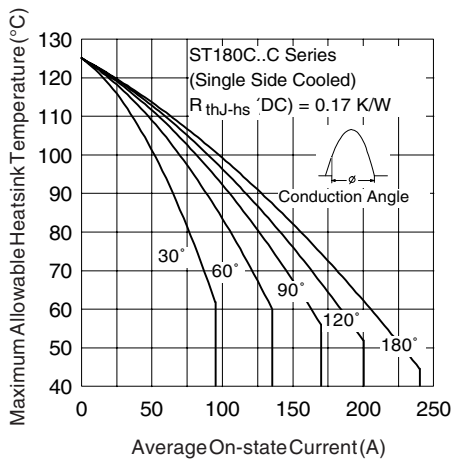
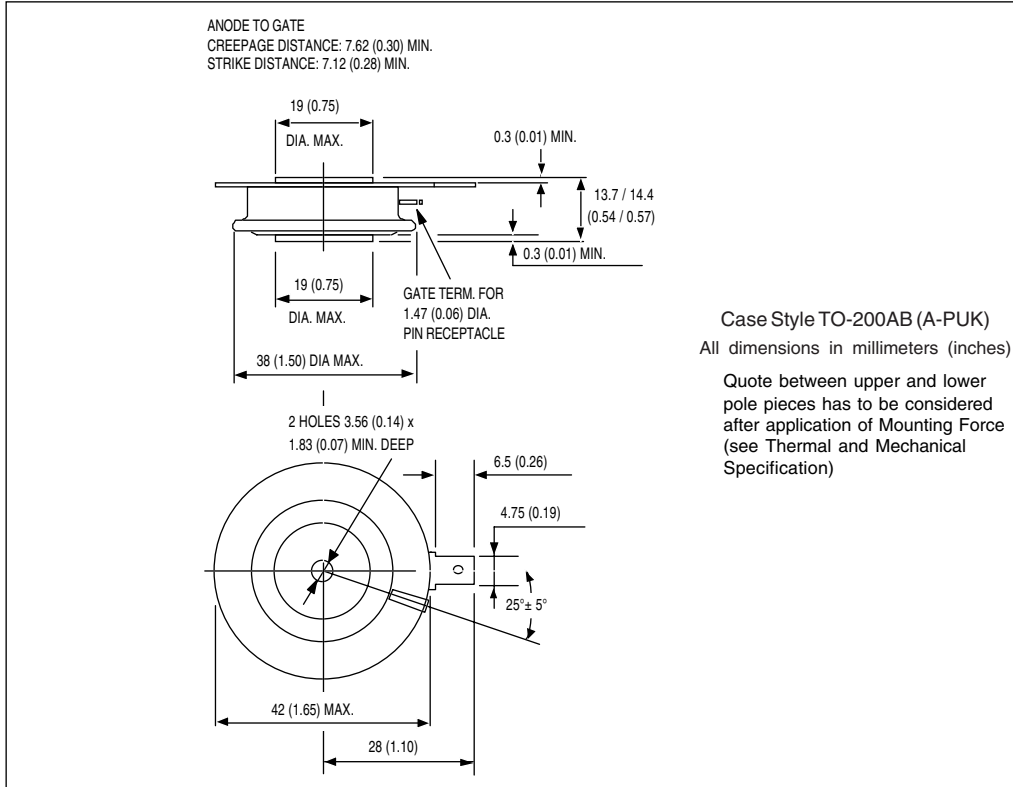

Fig. 1 - Current Ratings Characteristics

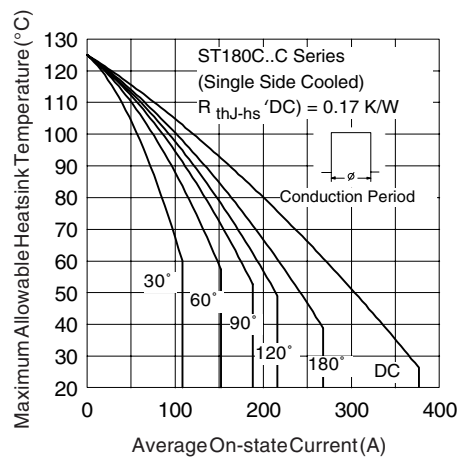

Fig. 2 - Current Ratings Characteristics

ST180C..C Series

Bulletin I25164 rev. C 02/00

International
IRF Rectifier

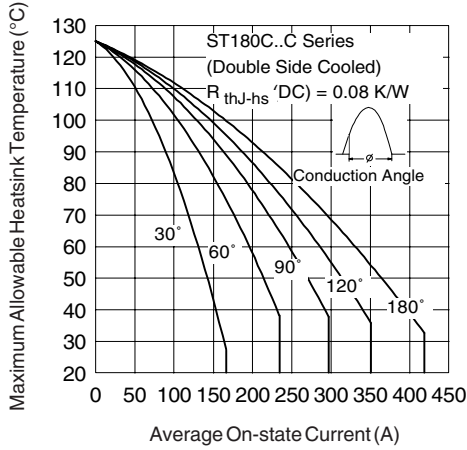

Fig. 3 - Current Ratings Characteristics

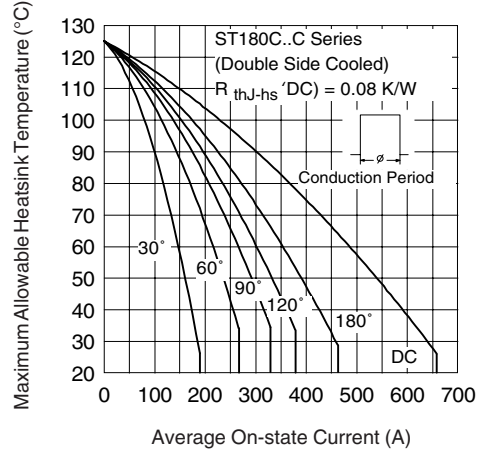

Fig. 4 - Current Ratings Characteristics

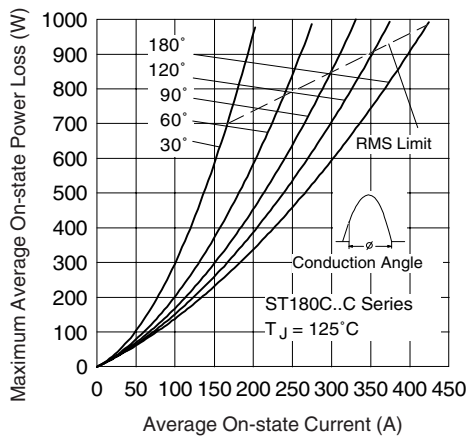

Fig. 5 - On-state Power Loss Characteristics

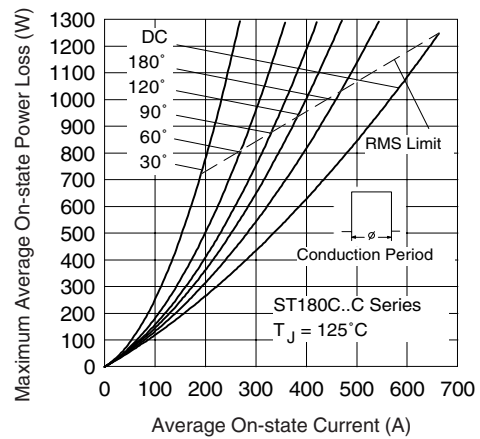

Fig. 6 - On-state Power Loss Characteristics

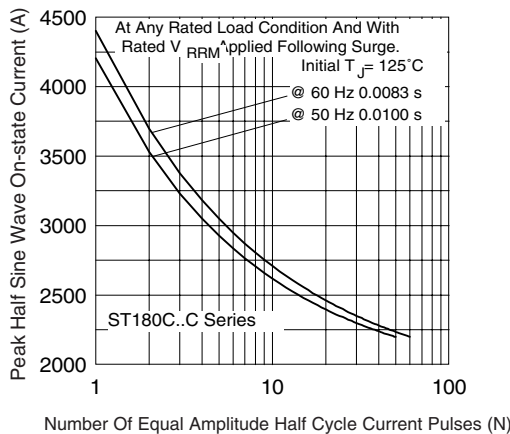

Fig. 7 - Maximum Non-Repetitive Surge Current Single and Double Side Cooled

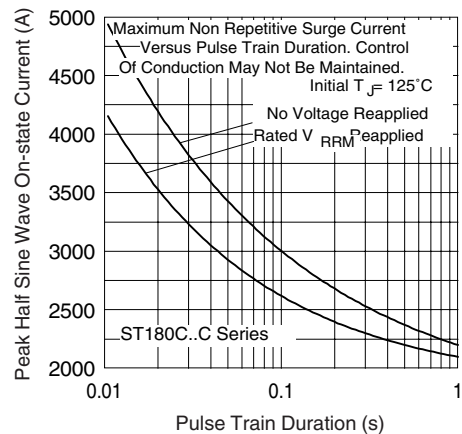

Fig. 8 - Maximum Non-Repetitive Surge Current Single and Double Side Cooled

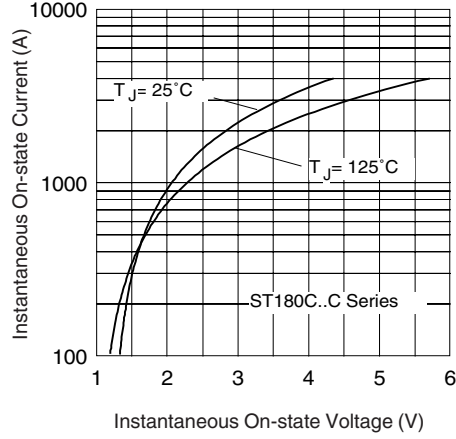

Fig. 9 - On-state Voltage Drop Characteristics

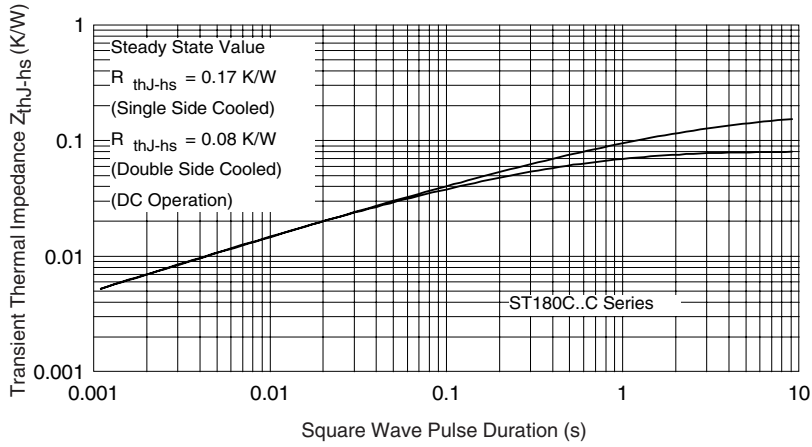

Fig. 10 - Thermal Impedance Z_{thJ-hs} Characteristics

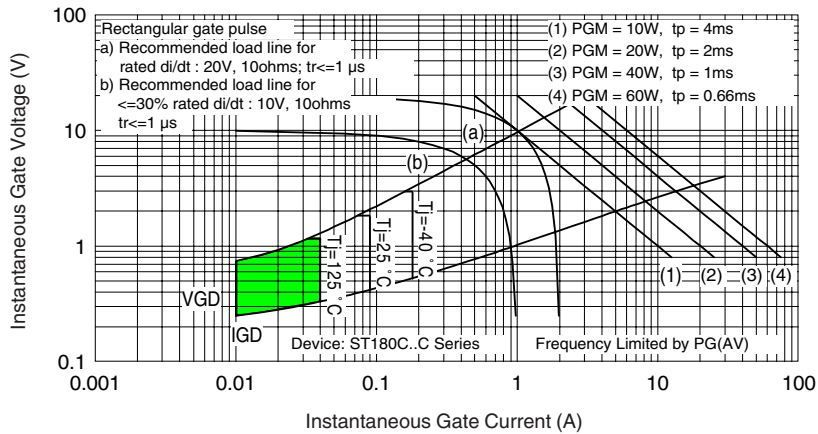

Fig. 11 - Gate Characteristics