

PHASE CONTROL THYRISTORS

Hockey Puk Version

410A

Features

- Center amplifying gate
- Metal case with ceramic insulator
- International standard case TO-200AB (A-PUK)

Typical Applications

- DC motor controls
- Controlled DC power supplies
- AC controllers



case style TO-200AB (A-PUK)

Major Ratings and Characteristics

Parameters	ST230C..C	Units
$I_{T(AV)}$	410	A
@ T_{hs}	55	°C
$I_{T(RMS)}$	780	A
@ T_{hs}	25	°C
I_{TSM}	@ 50Hz 5700	A
	@ 60Hz 5970	A
I^2t	@ 50Hz 163	KA ² s
	@ 60Hz 149	KA ² s
V_{DRM}/V_{RRM}	400 to 1600	V
t_q typical	100	μs
T_J	- 40 to 125	°C

ST230C..C Series

ELECTRICAL SPECIFICATIONS

Voltage Ratings

Type number	Voltage Code	V_{DRM}/V_{RRM} , max. repetitive peak and off-state voltage V	V_{RSM} , maximum non-repetitive peak voltage V	I_{DRM}/I_{RRM} max. @ $T_J = T_J \text{ max}$ mA
ST230C..C	04	400	500	30
	08	800	900	
	12	1200	1300	
	14	1400	1500	
	16	1600	1700	

On-state Conduction

Parameter	ST230C..C	Units	Conditions	
$I_{T(AV)}$ Max. average on-state current @ Heatsink temperature	410 (165) 55 (85)	A °C	180° conduction, half sine wave double side (single side) cooled	
$I_{T(RMS)}$ Max. RMS on-state current	780	A	DC @ 25°C heatsink temperature double side cooled	
I_{TSM} Max. peak, one-cycle non-repetitive surge current	5700		t = 10ms	No voltage
	5970		t = 8.3ms	reapplied
	4800		t = 10ms	100% V_{RRM}
	5000		t = 8.3ms	reapplied
I^2t Maximum I^2t for fusing	163	KA ² s	t = 10ms	No voltage
	148		t = 8.3ms	reapplied
	115		t = 10ms	100% V_{RRM}
	105		t = 8.3ms	reapplied
$I^2\sqrt{t}$ Maximum $I^2\sqrt{t}$ for fusing	1630	KA ² √s	t = 0.1 to 10ms, no voltage reapplied	
$V_{T(TO)1}$ Low level value of threshold voltage	0.92	V	$(16.7\% \times \pi \times I_{T(AV)} < I < \pi \times I_{T(AV)})$, $T_J = T_J \text{ max.}$	
$V_{T(TO)2}$ High level value of threshold voltage	0.98		$(I > \pi \times I_{T(AV)})$, $T_J = T_J \text{ max.}$	
r_{t1} Low level value of on-state slope resistance	0.88	mΩ	$(16.7\% \times \pi \times I_{T(AV)} < I < \pi \times I_{T(AV)})$, $T_J = T_J \text{ max.}$	
r_{t2} High level value of on-state slope resistance	0.81		$(I > \pi \times I_{T(AV)})$, $T_J = T_J \text{ max.}$	
V_{TM} Max. on-state voltage	1.69	V	$I_{pk} = 880A$, $T_J = T_J \text{ max.}$, $t_p = 10ms$ sine pulse	
I_H Maximum holding current	600	mA	$T_J = 25^\circ C$, anode supply 12V resistive load	
I_L Max. (typical) latching current	1000 (300)			

Switching

Parameter	ST230C..C	Units	Conditions
di/dt Max. non-repetitive rate of rise of turned-on current	1000	A/μs	Gate drive 20V, 20Ω, $t_r \leq 1\mu s$ $T_J = T_J \text{ max.}$, anode voltage $\leq 80\% V_{DRM}$
t_d Typical delay time	1.0	μs	Gate current 1A, $di_g/dt = 1A/\mu s$ $V_d = 0.67\% V_{DRM}$, $T_J = 25^\circ C$
t_q Typical turn-off time	100		$I_{TM} = 300A$, $T_J = T_J \text{ max.}$, $di/dt = 20A/\mu s$, $V_R = 50V$ $dv/dt = 20V/\mu s$, Gate 0V 100Ω, $t_p = 500\mu s$

Blocking

Parameter	ST230C..C	Units	Conditions
dv/dt Maximum critical rate of rise of	500 off-state voltage	V/ μ s	$T_J = T_J$ max. linear to 80% rated V_{DRM}
I_{DRM} I_{RRM} Max. peak reverse and off-state leakage current	30	mA	$T_J = T_J$ max, rated V_{DRM}/V_{RRM} applied

Triggering

Parameter	ST230C..C	Units	Conditions
P_{GM} Maximum peak gate power	10.0	W	$T_J = T_J$ max, $t_p \leq 5$ ms
$P_{G(AV)}$ Maximum average gate power	2.0		$T_J = T_J$ max, $f = 50$ Hz, $d\% = 50$
I_{GM} Max. peak positive gate current	3.0	A	$T_J = T_J$ max, $t_p \leq 5$ ms
$+V_{GM}$ Maximum peak positive gate voltage	20	V	$T_J = T_J$ max, $t_p \leq 5$ ms
$-V_{GM}$ Maximum peak negative gate voltage	5.0		
I_{GT} DC gate current required to trigger	TYP.	MAX.	$T_J = -40^\circ\text{C}$ $T_J = 25^\circ\text{C}$ $T_J = 125^\circ\text{C}$ Max. required gate trigger/ current/ voltage are the lowest value which will trigger all units 12V anode-to-cathode applied
	180	-	
	90	150	
V_{GT} DC gate voltage required to trigger	2.9	-	$T_J = -40^\circ\text{C}$ $T_J = 25^\circ\text{C}$ $T_J = 125^\circ\text{C}$
	1.8	3.0	
	1.2	-	
I_{GD} DC gate current not to trigger	10	mA	$T_J = T_J$ max Max. gate current/voltage not to trigger is the max. value which will not trigger any unit with rated V_{DRM} anode-to-cathode applied
V_{GD} DC gate voltage not to trigger	0.25	V	

Thermal and Mechanical Specification

Parameter	ST230C..C	Units	Conditions
T_J Max. operating temperature range	-40 to 125	$^\circ\text{C}$	
T_{stg} Max. storage temperature range	-40 to 150		
R_{thJ-hs} Max. thermal resistance, junction to heatsink	0.17	K/W	DC operation single side cooled
	0.08		DC operation double side cooled
R_{thC-hs} Max. thermal resistance, case to heatsink	0.033	K/W	DC operation single side cooled
	0.017		DC operation double side cooled
F Mounting force, $\pm 10\%$	4900	N	
	(500)	(Kg)	
wt Approximate weight	50	g	
Case style	TO-200AB (A-PUK)		See Outline Table

ST230C..C Series

ΔR_{thJ-hs} Conduction

(The following table shows the increment of thermal resistance R_{thJ-hs} when devices operate at different conduction angles than DC)

Conduction angle	Sinusoidal conduction		Rectangular conduction		Units	Conditions
	Single Side	Double Side	Single Side	Double Side		
180°	0.015	0.017	0.011	0.011	K/W	$T_J = T_{J \text{ max.}}$
120°	0.018	0.019	0.019	0.019		
90°	0.024	0.024	0.026	0.026		
60°	0.035	0.035	0.036	0.037		
30°	0.060	0.060	0.060	0.061		

Ordering Information Table

Device Code

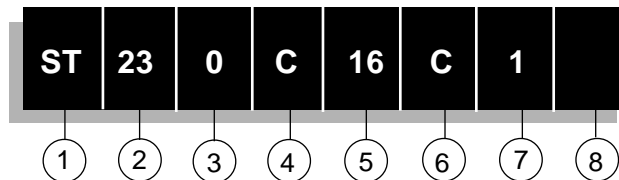

- 1** - Thyristor
- 2** - Essential part number
- 3** - 0 = Converter grade
- 4** - C = Ceramic Puk
- 5** - Voltage code: Code x 100 = V_{RRM} (See Voltage Rating Table)
- 6** - C = Puk Case TO-200AB (A-PUK)
- 7** - 0 = Eyelet terminals (Gate and Auxiliary Cathode Unsoldered Leads)
 1 = Fast-on terminals (Gate and Auxiliary Cathode Unsoldered Leads)
 2 = Eyelet terminals (Gate and Auxiliary Cathode Soldered Leads)
 3 = Fast-on terminals (Gate and Auxiliary Cathode Soldered Leads)
- 8** - Critical dv/dt: None = 500V/ μ sec (Standard selection)
 L = 1000V/ μ sec (Special selection)

Outline Table

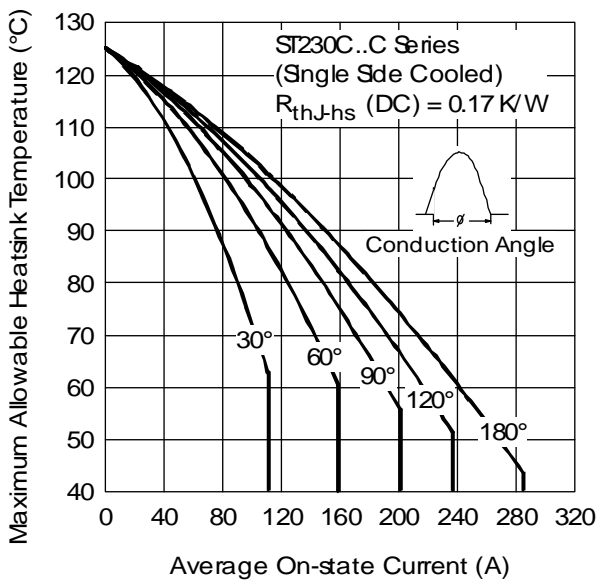
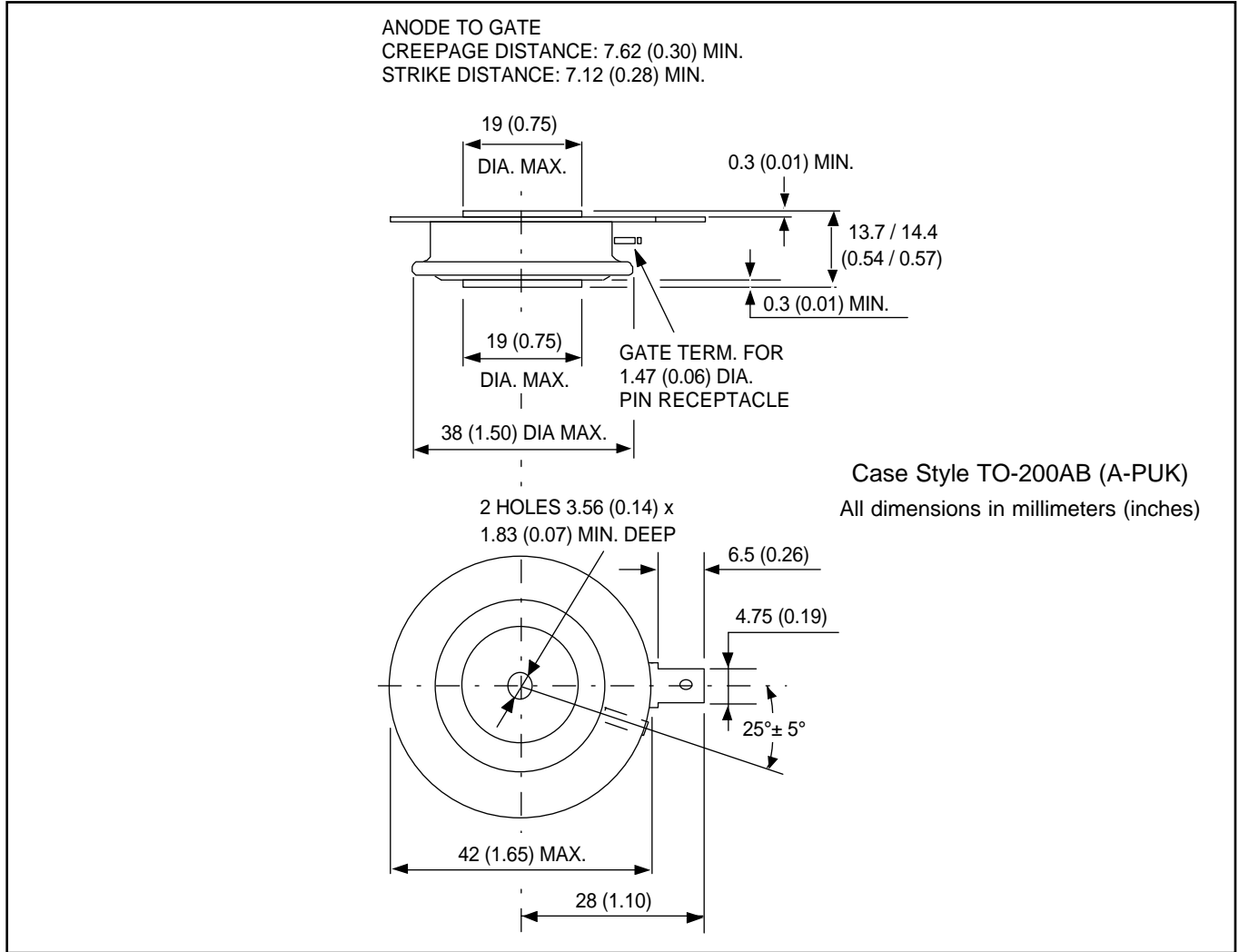

Fig. 1 - Current Ratings Characteristics

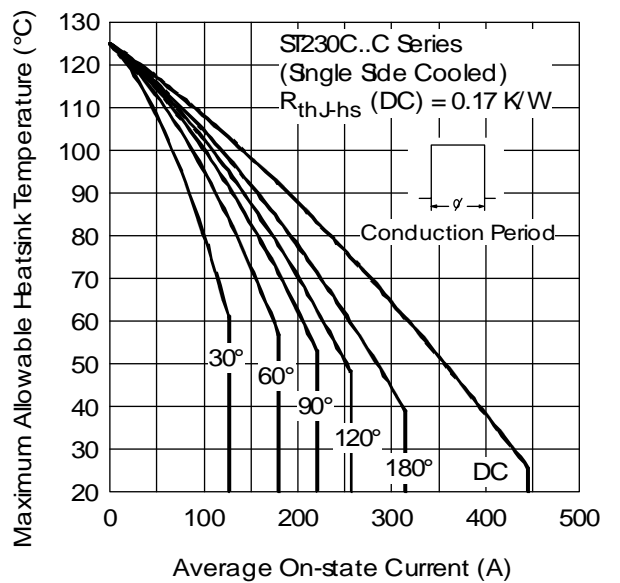

Fig. 2 - Current Ratings Characteristics

ST230C..C Series

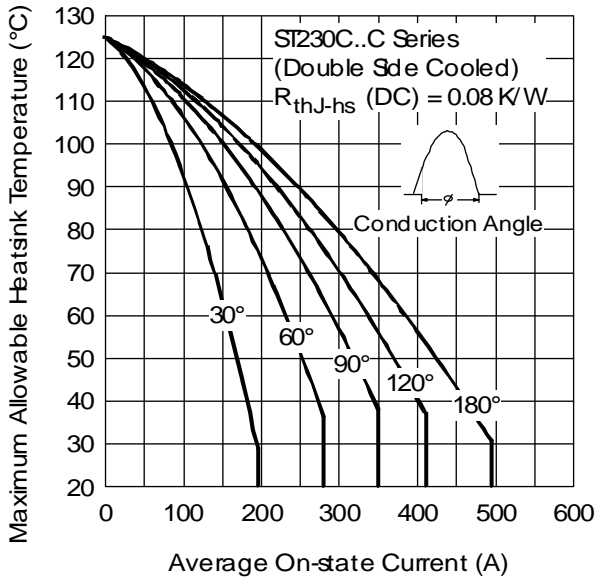

Fig. 3 - Current Ratings Characteristics

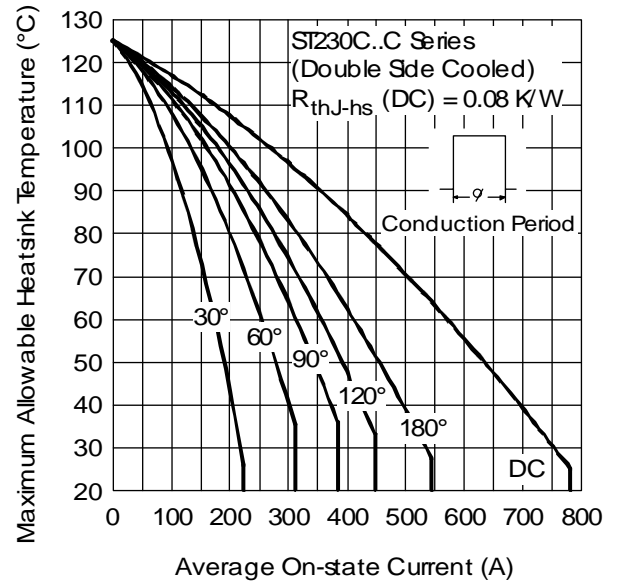

Fig. 4 - Current Ratings Characteristics

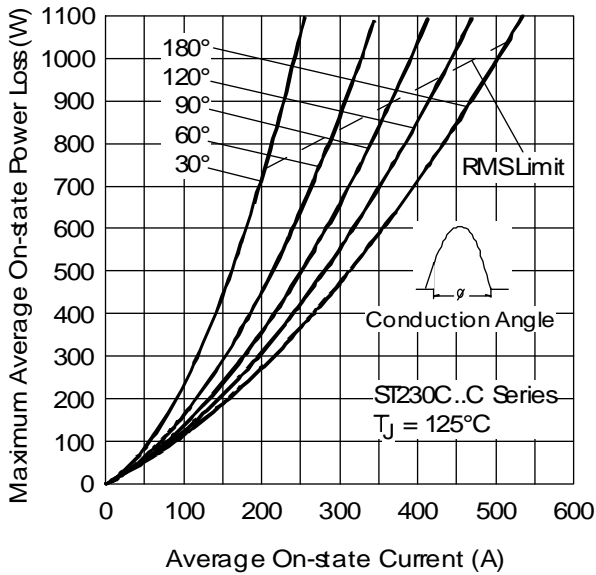

Fig. 5 - On-state Power Loss Characteristics

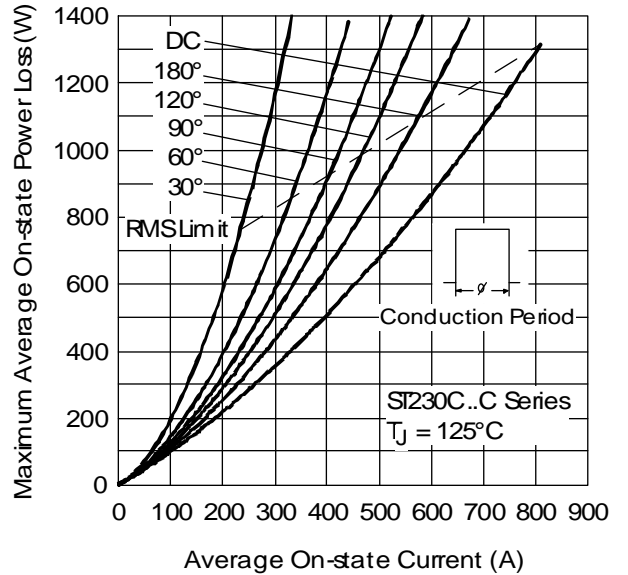

Fig. 6 - On-state Power Loss Characteristics

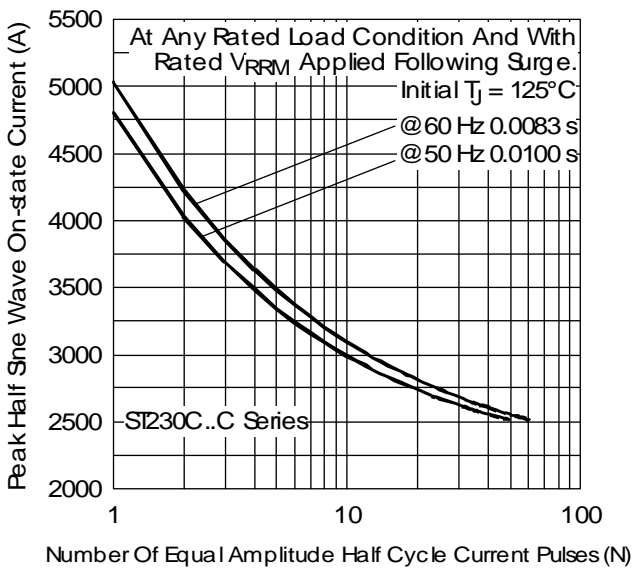

Fig. 7 - Maximum Non-Repetitive Surge Current Single and Double Side Cooled

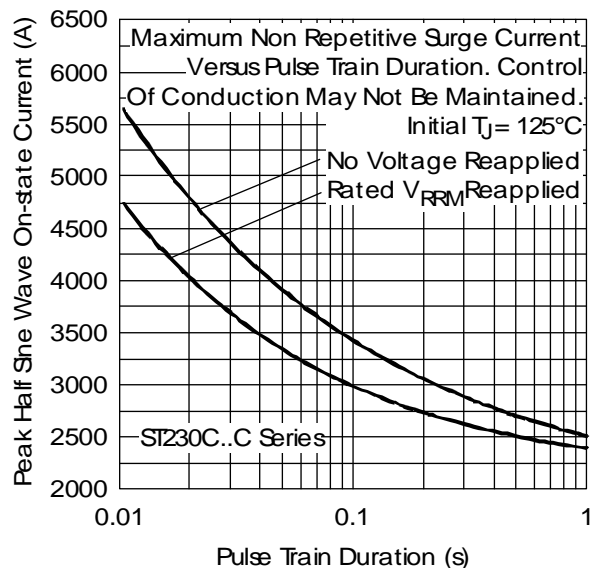

Fig. 8 - Maximum Non-Repetitive Surge Current Single and Double Side Cooled

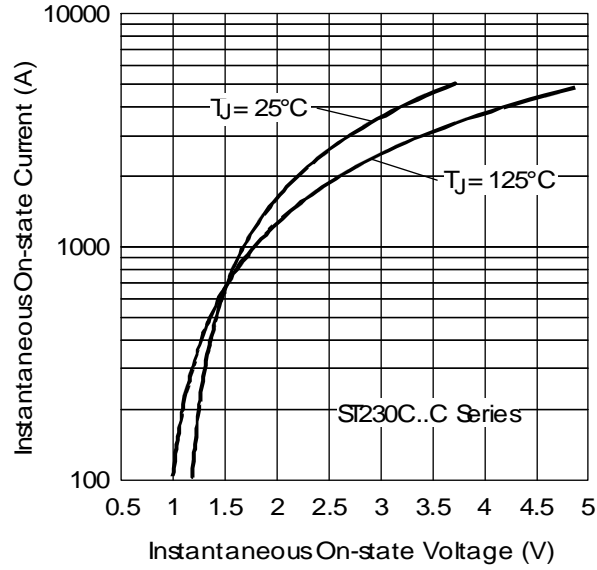

Fig. 9 - On-state Voltage Drop Characteristics

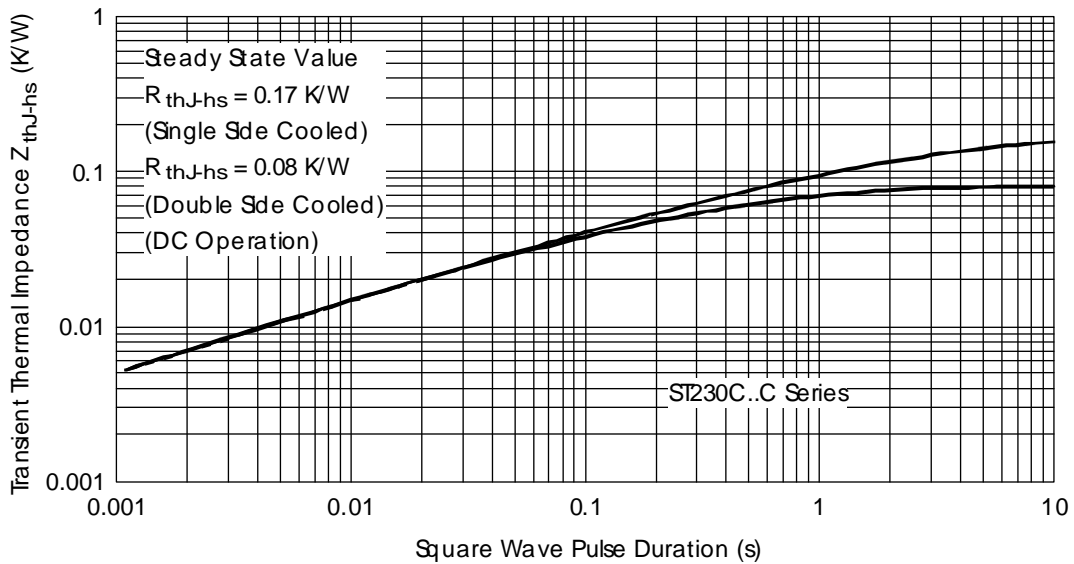

Fig. 10 - Thermal Impedance Z_{thJ-hs} Characteristics

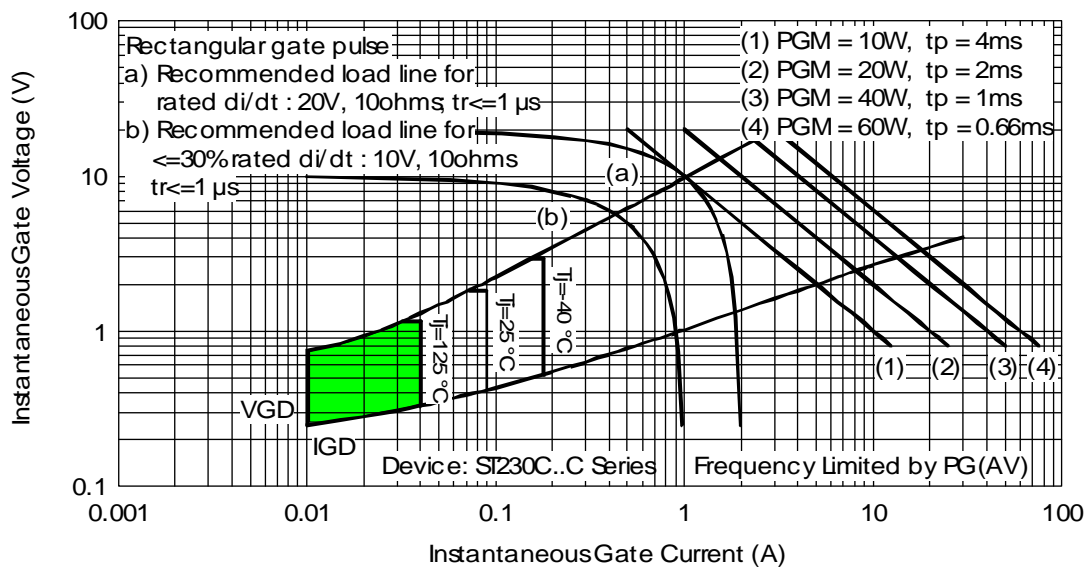

Fig. 11 - Gate Characteristics