

INVERTER GRADE THYRISTORS

Hockey Puk Version

Features

- Metal case with ceramic insulator
- International standard case TO-200AC (B-PUK)
- All diffused design
- Center amplifying gate
- Guaranteed high dV/dt
- Guaranteed high dI/dt
- High surge current capability
- Low thermal impedance
- High speed performance

Typical Applications

- Inverters
- Choppers
- Induction heating
- All types of force-commutated converters

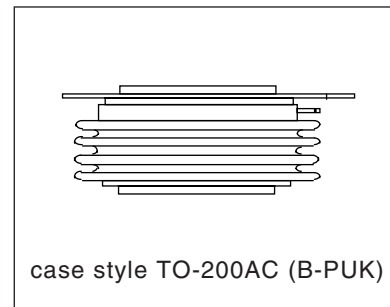
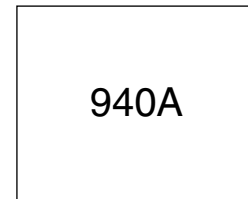

Major Ratings and Characteristics

Parameters	ST733C..L	Units
$I_{T(AV)}$	940	A
@ T_{hs}	55	°C
$I_{T(RMS)}$	1900	A
@ T_{hs}	25	°C
I_{TSM}	@ 50Hz 20000	A
	@ 60Hz 20950	A
I^2t	@ 50Hz 2000	KA ² s
	@ 60Hz 1820	KA ² s
V_{DRM}/V_{RRM}	400 to 800	V
t_q range	10 to 20	μs
T_J	- 40 to 125	°C

ST733C..L Series

Bulletin I25188 rev. A 04/00

International
 Rectifier

ELECTRICAL SPECIFICATIONS

Voltage Ratings

Type number	Voltage Code	V_{DRM}/V_{RRM} , maximum repetitive peak voltage V	V_{RSM} , maximum non-repetitive peak voltage V	I_{DRM}/I_{RRM} max. @ $T_J = T_{J \text{ max.}}$ mA
ST733C..L	04	400	500	75
	08	800	900	

Current Carrying Capability

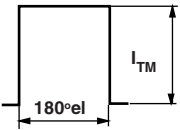
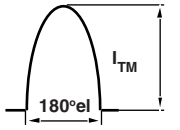
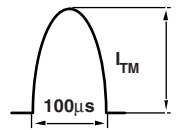
Frequency							Units
	I_{TM}	I_{TM}	I_{TM}	I_{TM}	I_{TM}	I_{TM}	
50Hz	2200	1900	3580	3100	6800	5920	A
400Hz	2050	1660	3600	3130	3750	3240	
1000Hz	1370	1070	2900	2450	2120	1780	
2500Hz	500	370	1220	980	960	770	
Recovery voltage Vr	50	50	50	50	50	50	V
Voltage before turn-on Vd	V_{DRM}		V_{DRM}		V_{DRM}		
Rise of on-state current di/dt	50	50	-	-	-	-	A/µs
Heatsink temperature	40	55	40	55	40	55	°C
Equivalent values for RC circuit	10Ω / 0.47µF		10Ω / 0.47µF		10Ω / 0.47µF		

On-state Conduction

Parameter	ST733C..L	Units	Conditions		
$I_{T(AV)}$ Max. average on-state current @ Heatsink temperature	940 (350)	A	180° conduction, half sine wave double side (single side) cooled		
	55 (85)	°C			
$I_{T(RMS)}$ Max. RMS on-state current	1900	A	DC @ 25°C heatsink temperature double side cooled		
I_{TSM} Max. peak, one half cycle, non-repetitive surge current	20000		t = 10ms	No voltage	Sinusoidal half wave, Initial $T_J = T_{J \text{ max}}$
	20950		t = 8.3ms	reapplied	
	16800		t = 10ms	100% V_{RRM}	
17600	t = 8.3ms	reapplied			
I^2t Maximum I^2t for fusing	2000	KA ² s	t = 10ms	No voltage	
	1820		t = 8.3ms	reapplied	
	1410		t = 10ms	100% V_{RRM}	
	1290		t = 8.3ms	reapplied	
$I^2\sqrt{t}$ Maximum $I^2\sqrt{t}$ for fusing	20000	KA ² √s	t = 0.1 to 10ms, no voltage reapplied		

On-state Conduction

Parameter	ST733C..L	Units	Conditions
V_{TM} Max. peak on-state voltage	1.63	V	$I_{TM} = 1700A, T_J = T_J \text{ max}, t_p = 10\text{ms sine wave pulse}$
$V_{T(TO)1}$ Low level value of threshold voltage	1.09		$(16.7\% \times \pi \times I_{T(AV)} < I < \pi \times I_{T(AV)}, T_J = T_J \text{ max.}$
$V_{T(TO)2}$ High level value of threshold voltage	1.20		$(I > \pi \times I_{T(AV)}, T_J = T_J \text{ max.}$
r_{t1} Low level value of forward slope resistance	0.32	m Ω	$(16.7\% \times \pi \times I_{T(AV)} < I < \pi \times I_{T(AV)}, T_J = T_J \text{ max.}$
r_{t2} High level value of forward slope resistance	0.29		$(I > \pi \times I_{T(AV)}, T_J = T_J \text{ max.}$
I_H Maximum holding current	600	mA	$T_J = 25^\circ\text{C}, I_T > 30A$
I_L Typical latching current	1000		$T_J = 25^\circ\text{C}, V_A = 12V, R_a = 6\Omega, I_G = 1A$

Switching

Parameter	ST733C..L	Units	Conditions
di/dt Max. non-repetitive rate of rise of turned-on current	1000	A/ μs	$T_J = T_J \text{ max}, V_{DRM} = \text{rated } V_{DRM}, I_{TM} = 2 \times \text{di/dt}$ Gate pulse: 20V 20 Ω , 10 μs 0.5 μs rise time
t_d Typical delay time	1.5	μs	$T_J = 25^\circ\text{C}, V_{DM} = \text{rated } V_{DRM}, I_{TM} = 50A \text{ DC}, t_p = 1\mu\text{s}$ Resistive load, Gate pulse: 10V, 5 Ω source
t_q Max. turn-off time	Min 10 Max 20		$T_J = T_J \text{ max}, I_{TM} = 550A, \text{commutating di/dt} = -40A/\mu\text{s}$ $V_R = 50V, t_p = 500\mu\text{s}, \text{dv/dt: see table in device code}$

Blocking

Parameter	ST733C..L	Units	Conditions
dv/dt Maximum critical rate of rise of off-state voltage	500	V/ μs	$T_J = T_J \text{ max. linear to } 80\% V_{DRM}, \text{higher value available on request}$
I_{RRM} I_{DRM} Max. peak reverse and off-state leakage current	75	mA	$T_J = T_J \text{ max, rated } V_{DRM}/V_{RRM} \text{ applied}$

Triggering

Parameter	ST733C..L	Units	Conditions
P_{GM} Maximum peak gate power	60	W	$T_J = T_J \text{ max.}, f = 50\text{Hz}, d\% = 50$
$P_{G(AV)}$ Maximum average gate power	10		
I_{GM} Max. peak positive gate current	10	A	$T_J = T_J \text{ max}, t_p \leq 5\text{ms}$
$+V_{GM}$ Maximum peak positive gate voltage	20	V	$T_J = T_J \text{ max}, t_p \leq 5\text{ms}$
$-V_{GM}$ Maximum peak negative gate voltage	5		
I_{GT} Max. DC gate current required to trigger	200	mA	$T_J = 25^\circ\text{C}, V_A = 12V, R_a = 6\Omega$
V_{GT} Max. DC gate voltage required to trigger	3		
I_{GD} Max. DC gate current not to trigger	20	mA	$T_J = T_J \text{ max, rated } V_{DRM} \text{ applied}$
V_{GD} Max. DC gate voltage not to trigger	0.25		

ST733C..L Series

Bulletin I25188 rev. A 04/00

International
IRF Rectifier

Thermal and Mechanical Specification

Parameter	ST733C..L	Units	Conditions
T_J Max. operating temperature range	-40 to 125	°C	
T_{stg} Max. storage temperature range	-40 to 150		
R_{thJ-hs} Max. thermal resistance, junction to heatsink	0.073 0.031	K/W	DC operation single side cooled DC operation double side cooled
R_{thC-hs} Max. thermal resistance, case to heatsink	0.011 0.005	K/W	DC operation single side cooled DC operation double side cooled
F Mounting force, $\pm 10\%$	14700 (1500)	N (Kg)	
wt Approximate weight	255	g	
Case style	TO - 200AC (B-PUK)		See Outline Table

ΔR_{thJ-hs} Conduction

(The following table shows the increment of thermal resistance R_{thJ-hs} when devices operate at different conduction angles than DC)

Conduction angle	Sinusoidal conduction		Rectangular conduction		Units	Conditions
	Single Side	Double Side	Single Side	Double Side		
180°	0.009	0.009	0.006	0.006	K/W	$T_J = T_J \text{ max.}$
120°	0.011	0.011	0.011	0.011		
90°	0.014	0.014	0.015	0.015		
60°	0.020	0.021	0.021	0.022		
30°	0.036	0.036	0.036	0.036		

Ordering Information Table

Device Code

ST	73	3	C	08	L	H	K	1	
1	2	3	4	5	6	7	8	9	10

- 1** - Thyristor
- 2** - Essential part number
- 3** - 3 = Fast turn off
- 4** - C = Ceramic Puk
- 5** - Voltage code: Code x 100 = V_{RRM} (See Voltage Rating Table)
- 6** - L = Puk Case TO-200AC (B-PUK)
- 7** - Reapplied dv/dt code (for t_q test condition)
- 8** - t_q code
- 9** - 0 = Eyelet term. (Gate and Aux. Cathode Unsoldered Leads)
 1 = Fast-on term. (Gate and Aux. Cathode Unsoldered Leads)
 2 = Eyelet term. (Gate and Aux. Cathode Soldered Leads)
 3 = Fast-on term. (Gate and Aux. Cathode Soldered Leads)
- 10** - Critical dv/dt:
 None = 500V/ μ sec (Standard value)
 L = 1000V/ μ sec (Special selection)

dv/dt - t_q combinations available					
dv/dt (V/ μ s)	20	50	100	200	400
10	CN	DN	EN	--	--
12	CM	DM	EM	FM *	--
15	CL	DL	EL	FL *	HL
18	CP	DP	EP	FP	HP
20	CK	DK	EK	FK	H

* Standard part number.
All other types available only on request.

Outline Table

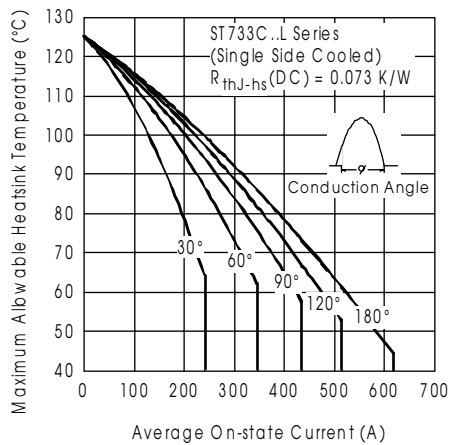
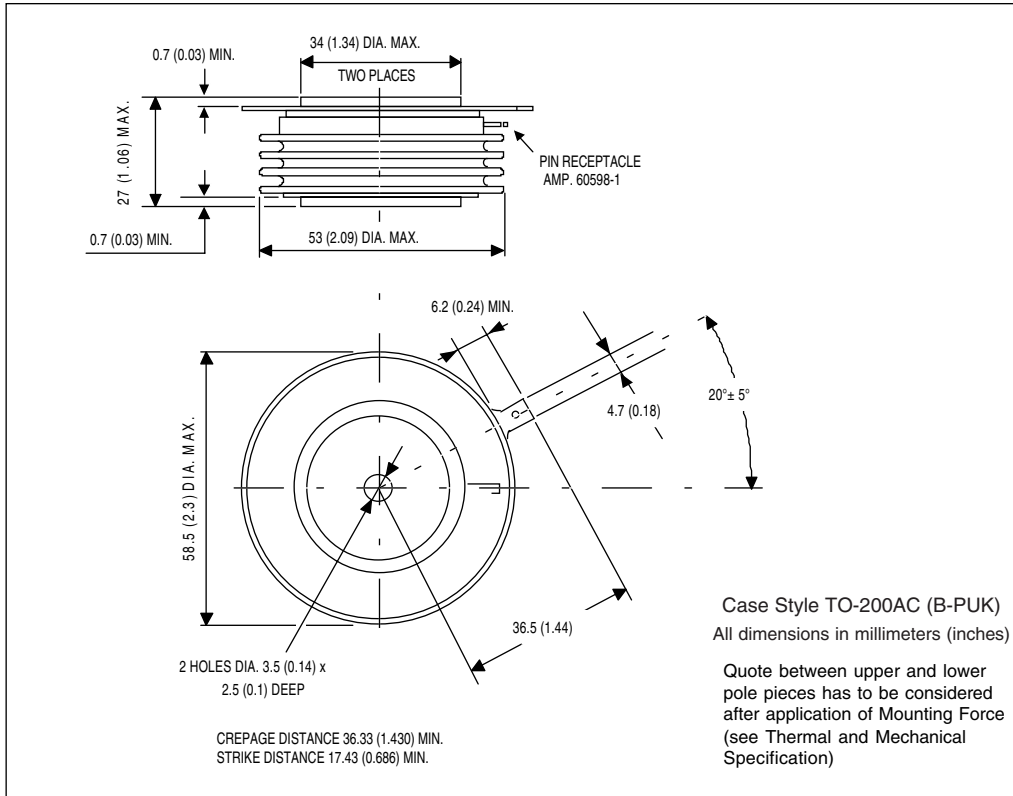

Fig. 1 - Current Ratings Characteristics

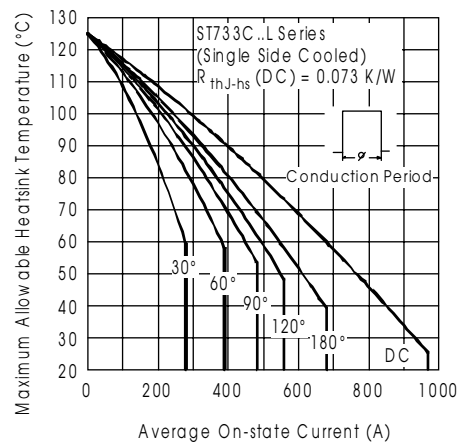

Fig. 2 - Current Ratings Characteristics

ST733C..L Series

Bulletin I25188 rev. A 04/00

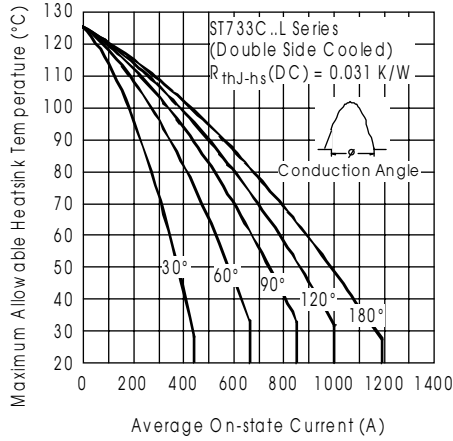

Fig. 3-Current Ratings Characteristics

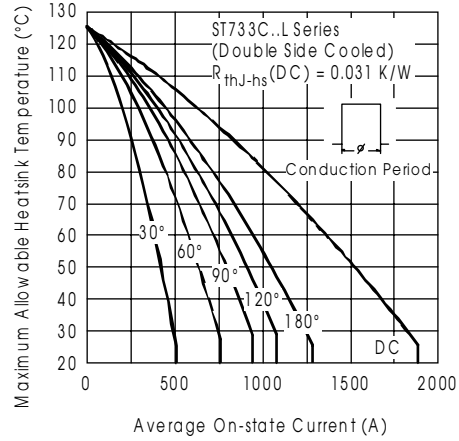

Fig. 4-Current Ratings Characteristics

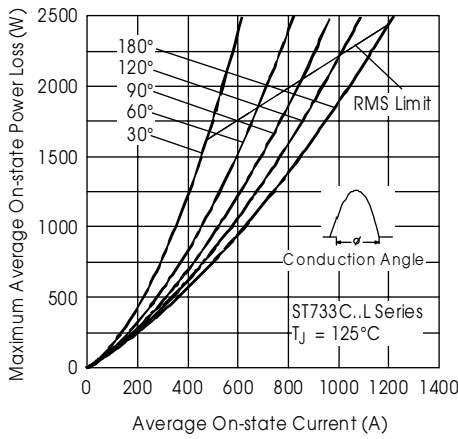

Fig. 5-On-state Power Loss Characteristics

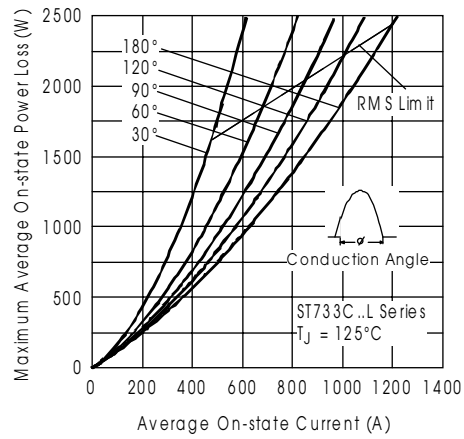

Fig. 6-On-state Power Loss Characteristics

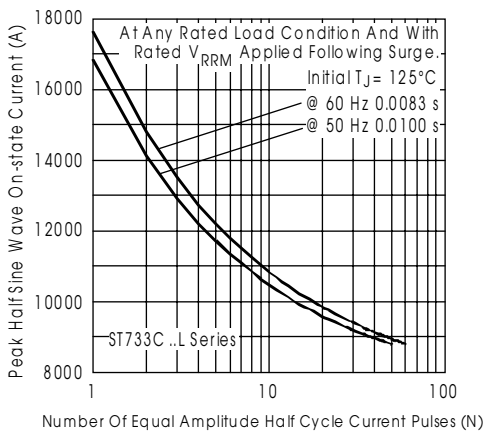

Fig. 7- Maximum Non-repetitive Surge Current Single and Double Side Cooled

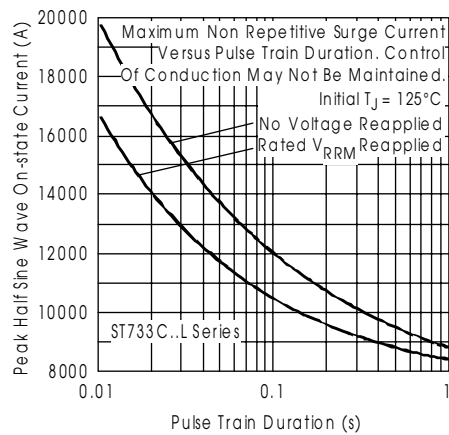

Fig. 8- Maximum Non-repetitive Surge Current Single and Double Side Cooled

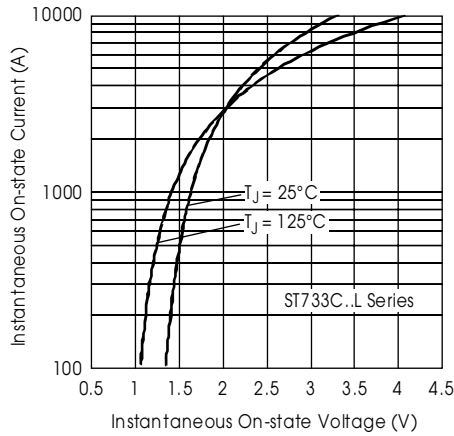

Fig. 9 - On-state Voltage Drop Characteristics

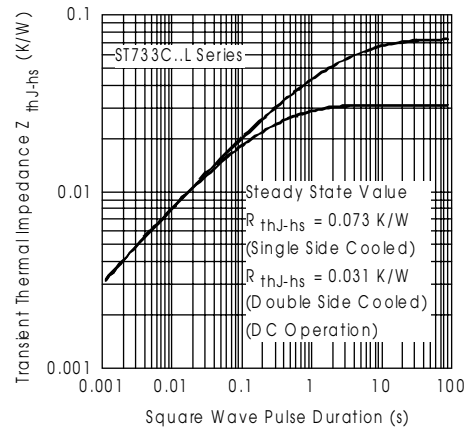

Fig. 10 - Thermal Impedance Z_{thJ-hs} Characteristic

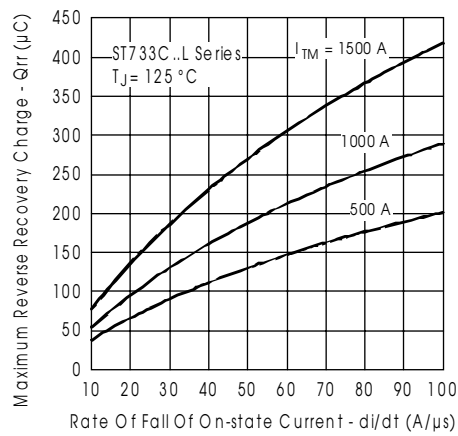

Fig. 11 - Reverse Recovered Charge Characteristics

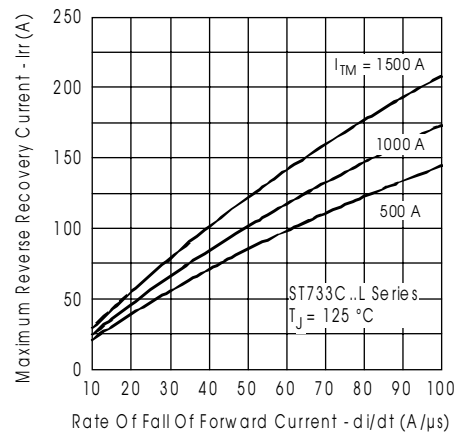

Fig. 12 - Reverse Recovery Current Characteristics

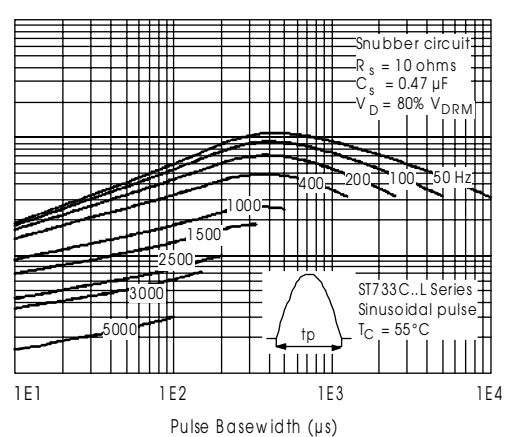
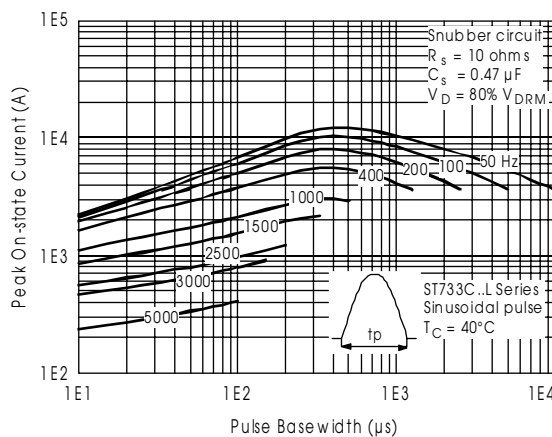

Fig. 13 - Frequency Characteristics

ST733C..L Series

Bulletin I25188 rev. A 04/00

International
 Rectifier

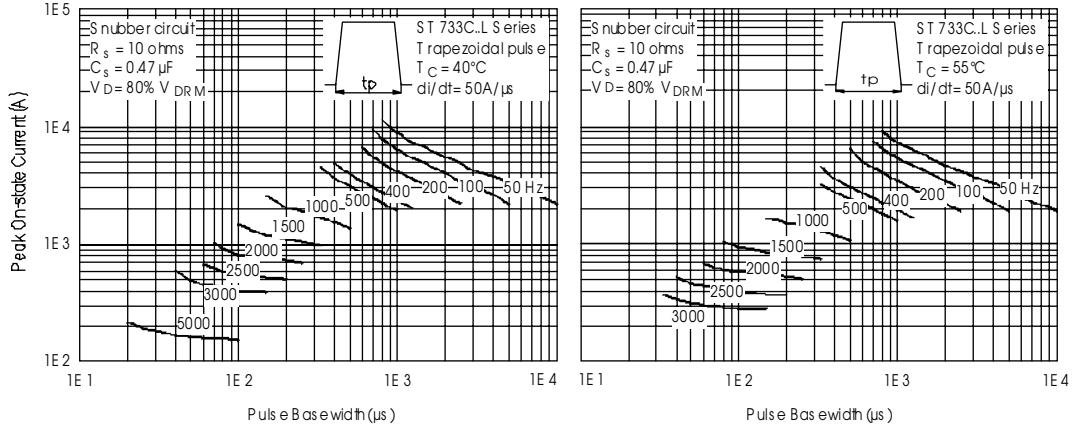

Fig. 14-Frequency Characteristics

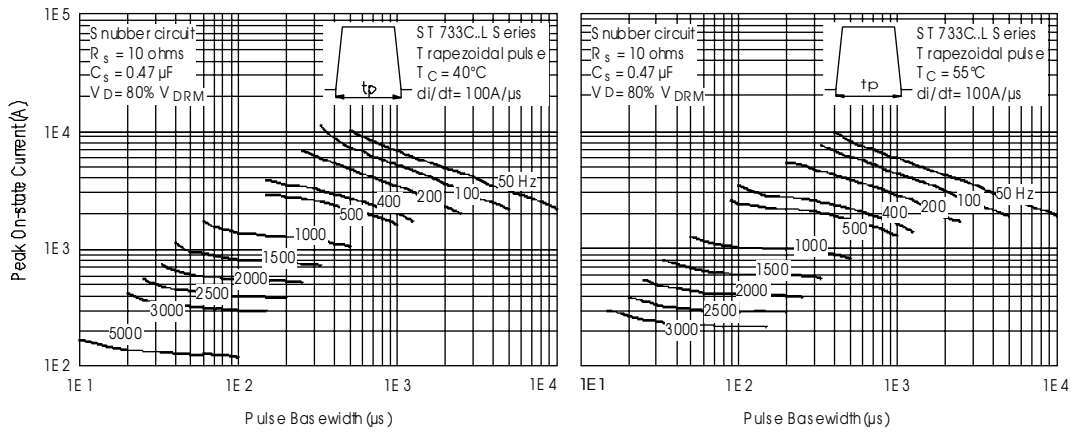

Fig. 15-Frequency Characteristics

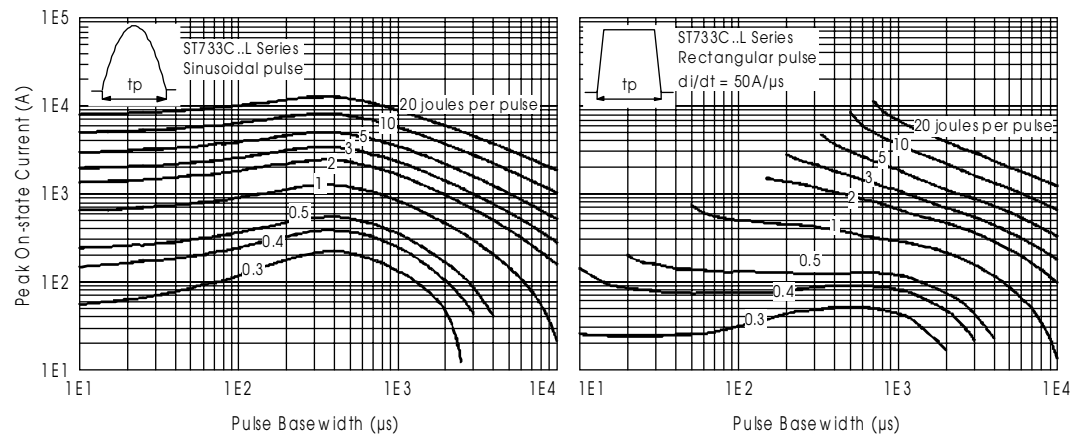

Fig. 16-Maximum On-state Energy Power Loss Characteristics

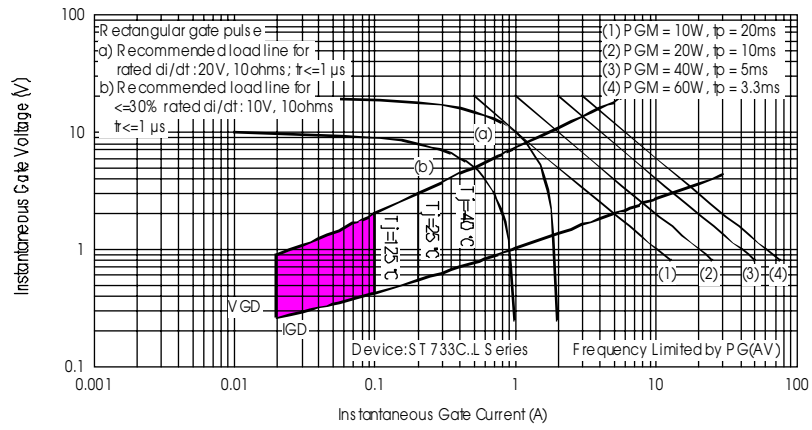

Fig.17-Gate Characteristics