

# TRIAC (ISOLATED TYPE)

# TG35C/E/D



UL;E76102 (M)

TG35C/E/D are isolated molded triacs suitable for wide range of applications like copier, microwave oven, solid state switch, motor control, light control and heater control.

- I<sub>T(AV)</sub> 35A
- High surge capability 330A
- Isolated Nounting (AC2500V)
- Tab Terminals

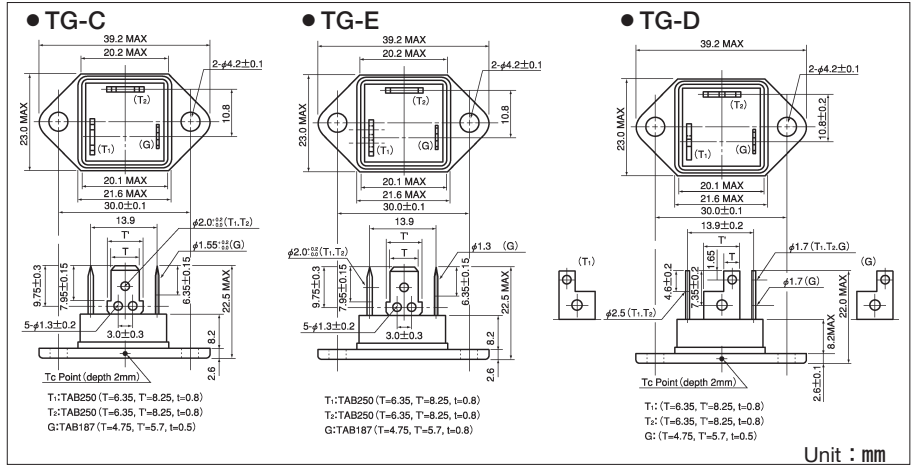
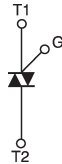

## Maximum Ratings

(T<sub>j</sub>=25°C unless otherwise specified)

Symbol	Item	Ratings		Unit
		TG35C40	TG35C60	
V <sub>DRM</sub>	Repetitive Peak Off-State Voltage	400	600	V

Symbol	Item	Conditions	Ratings	Unit
I <sub>T(RMS)</sub>	R.M.S. On-State Current	T <sub>c</sub> =58°C	35	A
I <sub>TSM</sub>	Surge On-State Current	One cycle, 50Hz/60Hz, peak, non-repetitive	300/330	A
I <sup>2</sup> t	I <sup>2</sup> t	Value for one cycle of surge current	450	A <sup>2</sup> S
P <sub>GM</sub>	Peak Gate Power Dissipation		10	W
P <sub>G(AV)</sub>	Average Gate Power Dissipation		1	W
I <sub>GM</sub>	Peak Gate Current		3	A
V <sub>GM</sub>	Peak Gate Voltage		10	V
di/dt	Critical Rate of Rise of On-State Current	I <sub>G</sub> =100mA, T <sub>j</sub> =25°C, V <sub>D</sub> =1/2 V <sub>DRM</sub> , dl <sub>G</sub> /dt=1A/μs	50	A/μs
T <sub>j</sub>	Operating Junction Temperature		-25~+125	°C
T <sub>stg</sub>	Storage Temperature		-40~+125	°C
V <sub>ISO</sub>	Isolation Breakdown Voltage (R.M.S.)	A.C.1 minute	2500	V
	Mounting Torque (M4)	Recommended Value 1.0~1.4 (10~14)	1.5 (15)	kgf·cm
	Mass	Typical value (Excluding bolt, nut and wrapping material)	23	g

## Electrical Characteristics

Symbol	Item	Conditions	Ratings	Unit
I <sub>DRM</sub>	Reptitive Peak Off-State Current, max	V <sub>D</sub> =V <sub>DRM</sub> , Single phase, half wave, T <sub>j</sub> =125°C	5	mA
V <sub>TM</sub>	Peak On-State Voltage, max	On-State Current (√2 × I <sub>T(RMS)</sub> ), Inst. measurement	1.4	V
I <sub>GT1</sub> <sup>+</sup>	Gate Trigger Current, max	T <sub>j</sub> =25°C, I <sub>T</sub> =1A, V <sub>D</sub> =6V	50	mA
I <sub>GT1</sub> <sup>-</sup>			50	
I <sub>GT3</sub> <sup>+</sup>		—		
I <sub>GT3</sub> <sup>-</sup>		T <sub>j</sub> =25°C, I <sub>T</sub> =1A, V <sub>D</sub> =6V	50	
V <sub>GT1</sub> <sup>+</sup>	Gate Trigger Voltage, max	T <sub>j</sub> =25°C, I <sub>T</sub> =1A, V <sub>D</sub> =6V	3	V
V <sub>GT1</sub> <sup>-</sup>			3	
V <sub>GT3</sub> <sup>+</sup>		—		
V <sub>GT3</sub> <sup>-</sup>		T <sub>j</sub> =25°C, I <sub>T</sub> =1A, V <sub>D</sub> =6V	3	
V <sub>GD</sub>	Non-Trigger Gate Voltage, min	T <sub>j</sub> =125°C, V <sub>D</sub> =1/2 V <sub>DRM</sub>	0.2	V
t <sub>gt</sub>	Turn On Time, max.	I <sub>T(RMS)</sub> , I <sub>G</sub> =100mA, V <sub>D</sub> =1/2 V <sub>DRM</sub> , T <sub>j</sub> =25°C, dl <sub>G</sub> /dt=1A/μs	10	V
dv/dt	Critical Rate of Rise on-State Voltage, min.	T <sub>j</sub> =125°C, V <sub>D</sub> =2/3 V <sub>DRM</sub> , Exponential wave.	20	V/μs
(dv/dt) <sub>c</sub>	Critical Rate of Rise off-State Voltage at commutation, min	T <sub>j</sub> =125°C, V <sub>D</sub> =2/3 V <sub>DRM</sub> , (di/dt) <sub>c</sub> =15A/ms	5	V/μs
I <sub>H</sub>	Holding Current, typ.	T <sub>j</sub> =25°C	30	mA
R <sub>th(j-c)</sub>	Thermal Impedance, max	Junction to case	1.5	°C/W

Gate Characteristics

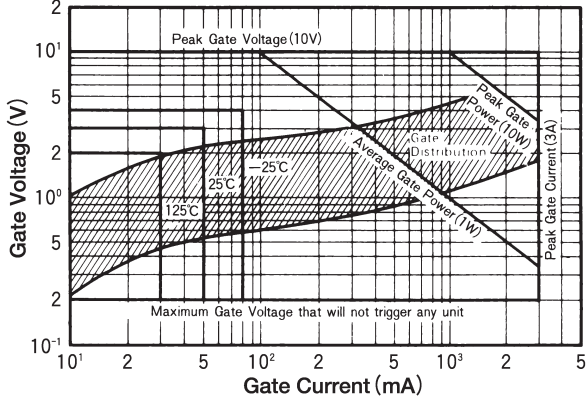

On-State Voltage

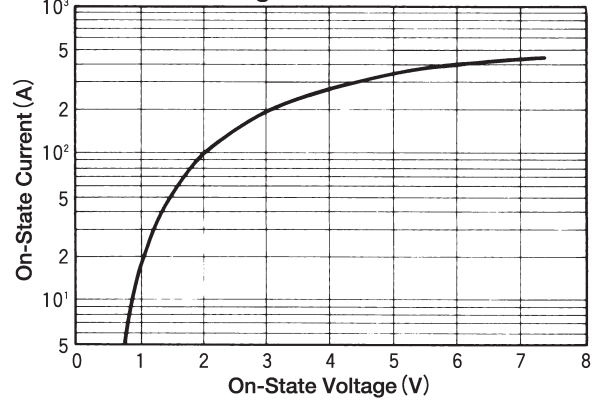

On State Current vs. Maximum Power Dissipation

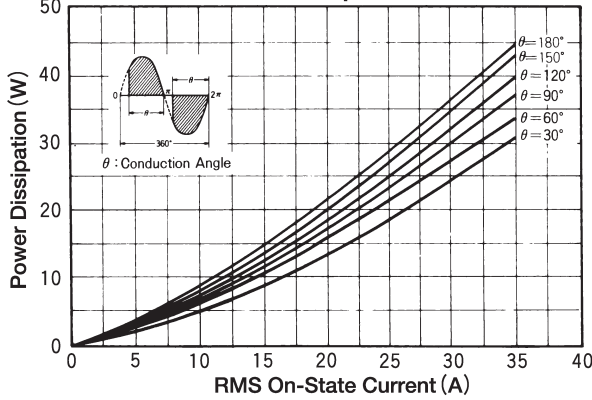

On State Current vs. Allowable Case Temperature

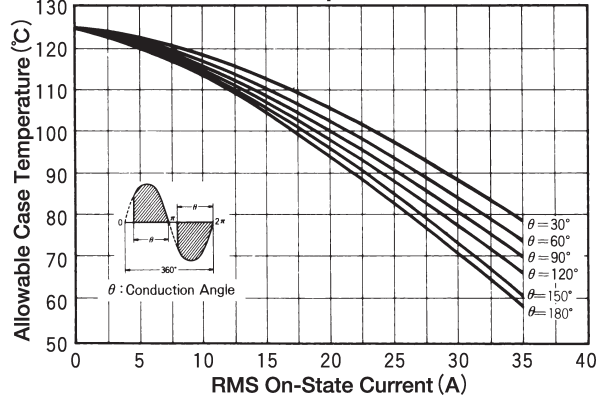

Ambient temp. vs. RMS On-State Current

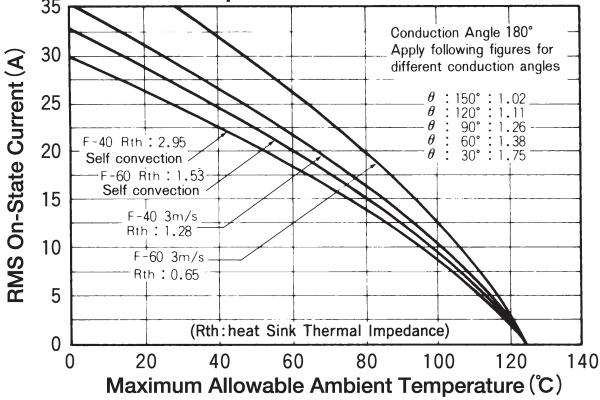

Surge On-State Current Rating (Non-Repetitive)

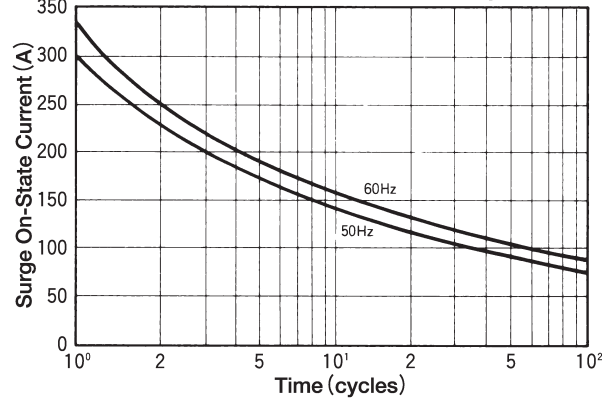

Transient Thermal Impedance

