

Elektrische Eigenschaften / Electrical properties

Höchstzulässige Werte / Maximum rated values

Periodische Vorwärts- und Rückwärts-Spitzensperrspannung repetitive peak forward off-state and reverse voltages	$T_{vj} = -40^{\circ}\text{C} \dots T_{vj\text{max}}$	$V_{\text{DRM}}, V_{\text{RRM}}$	1200, 1400 1600, 1800	V V
Vorwärts-Stoßspitzensperrspannung non-repetitive peak forward off-state voltage	$T_{vj} = -40^{\circ}\text{C} \dots T_{vj\text{max}}$	V_{DSM}	1200, 1400 1600, 1800	V V
Rückwärts-Stoßspitzensperrspannung non-repetitive peak reverse voltage	$T_{vj} = +25^{\circ}\text{C} \dots T_{vj\text{max}}$	V_{RSM}	1300, 1500 1700, 1900	V V
Durchlaßstrom-Grenzeffektivwert (pro Element) RMS on-state current (per chip)		I_{TRMSM}	75	A
Effektivstrom (pro Phase) RMS current (per arm)	$T_{\text{C}} = 85^{\circ}\text{C}$ $T_{\text{C}} = 72^{\circ}\text{C}$ $T_{\text{A}} = 45^{\circ}\text{C}, \text{KM 11}$ $T_{\text{A}} = 45^{\circ}\text{C}, \text{KM 33}$ $T_{\text{A}} = 35^{\circ}\text{C}, \text{KM 14 } (V_L = 45/\text{s})$ $T_{\text{A}} = 35^{\circ}\text{C}, \text{KM 33 } (V_L = 90/\text{s})$	I_{RMS}	85 106 35 49 83 96	A A A A A A
Stoßstrom-Grenzwert surge current	$T_{vj} = 25^{\circ}\text{C}, t_p = 10\text{ms}$ $T_{vj} = T_{vj\text{max}}, t_p = 10\text{ms}$	I_{TSM}	720 620	A A
Grenzlastintegral I^2t -value	$T_{vj} = 25^{\circ}\text{C}, t_p = 10\text{ms}$ $T_{vj} = T_{vj\text{max}}, t_p = 10\text{ms}$	I^2t	2600 1920	A^2s A^2s
Kritische Stromsteilheit critical rate of rise of on-state current	DIN IEC 747-6 $f = 50\text{Hz}, i_{\text{GM}} = 0,6\text{A}, di_{\text{G}}/dt = 0,6\text{A}/\mu\text{s}$	$(di/dt)_{\text{cr}}$	120	$\text{A}/\mu\text{s}$
Kritische Spannungssteilheit critical rate of rise of off-state voltage	$T_{vj} = T_{vj\text{max}}, V_{\text{D}} = 0,67 V_{\text{DRM}}$ 8. Kennbuchstabe / 8th letter F	$(dv/dt)_{\text{cr}}$	1000	$\text{V}/\mu\text{s}$

Charakteristische Werte / Characteristic values

Durchlaßspannung on-state voltage	$T_{vj} = T_{vj\text{max}}, I_{\text{T}} = 100\text{A}$	V_{T}	max. 1,64	V
Schleusenspannung threshold voltage	$T_{vj} = T_{vj\text{max}}$	$V_{(\text{T0})}$	0,95	V
Ersatzwiderstand slope resistance	$T_{vj} = T_{vj\text{max}}$	r_{T}	5,5	$\text{m}\Omega$
Zündstrom gate trigger current	$T_{vj} = 25^{\circ}\text{C}, V_{\text{D}} = 6\text{V}$	I_{GT}	max. 150	mA
Zündspannung gate trigger voltage	$T_{vj} = 25^{\circ}\text{C}, V_{\text{D}} = 6\text{V}$	V_{GT}	max. 2,5	V
Nicht zündender Steuerstrom gate non-trigger current	$T_{vj} = T_{vj\text{max}}, V_{\text{D}} = 6\text{V}$ $T_{vj} = T_{vj\text{max}}, V_{\text{D}} = 0,5 V_{\text{DRM}}$	I_{GD}	max. 5,0 max. 2,5	mA mA
Nicht zündende Steuerspannung gate non-trigger voltage	$T_{vj} = T_{vj\text{max}}, V_{\text{D}} = 0,5 V_{\text{DRM}}$	V_{GD}	max. 0,2	V
Haltestrom holding current	$T_{vj} = 25^{\circ}\text{C}, V_{\text{D}} = 6\text{V}, R_{\text{A}} = 5\Omega$	I_{H}	max. 200	mA
Einraststrom latching current	$T_{vj} = 25^{\circ}\text{C}, V_{\text{D}} = 6\text{V}, R_{\text{GK}} \geq 20\Omega$ $i_{\text{GM}} = 0,6\text{A}, di_{\text{G}}/dt = 0,6\text{A}/\mu\text{s}, t_{\text{G}} = 10\mu\text{s}$	I_{L}	max. 600	mA
Vorwärts- und Rückwärts-Sperrstrom forward off-state and reverse currents	$T_{vj} = T_{vj\text{max}}$ $V_{\text{D}} = V_{\text{DRM}}, V_{\text{R}} = V_{\text{RRM}}$	$i_{\text{D}}, i_{\text{R}}$	max. 8	mA
Zündverzögerung gate controlled delay time	DIN IEC 747-6 $T_{vj} = 25^{\circ}\text{C}, i_{\text{GM}} = 0,6\text{A}, di_{\text{G}}/dt = 0,6\text{A}/\mu\text{s}$	t_{gd}	max. 1,2	μs

Technische Information / Technical Information

eupec

Netz-Thyristor-Modul
Phase Control Thyristor Module **TT W3C 85 N 12...18 (ISOPACK)**

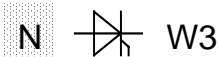

Elektrische Eigenschaften / Electrical properties

Charakteristische Werte / Characteristic values

Freiwerdezeit circuit commutated turn-off time	$T_{vj} = T_{vjmax}$ $I_{TM} = 50A$ $V_{RM} = 100V$, $V_{DM} = 0,67 V_{DRM}$ $dV/dt = 20V/\mu s$, $-di_T/dt = 10A/\mu s$ 7. Kennbuchstabe / 7th letter O	t_q	typ.	190	μs
Isolations-Prüfspannung insulation test voltage	RMS, $f = 50Hz$, $t = 1min$ RMS, $f = 50Hz$, $t = 1sec$	V_{ISOL}		3,0 3,6	kV kV

Thermische Eigenschaften / Thermal properties

Innerer Wärmewiderstand thermal resistance, junction to case	pro Modul / per module, $\Theta = 180^\circ sin$ pro Element / per chip, $\Theta = 180^\circ sin$ pro Modul / per module, DC pro Element / per chip, DC	R_{thJC}	max.	0,117 0,700 0,108 0,650	$^\circ C/W$ $^\circ C/W$ $^\circ C/W$ $^\circ C/W$
Übergangs-Wärmewiderstand thermal resistance, case to heatsink	pro Modul / per module pro Element / per chip	R_{thCK}	max.	0,033 0,200	$^\circ C/W$ $^\circ C/W$
Höchstzulässige Sperrschichttemperatur max. junction temperature		T_{vjmax}		125	$^\circ C$
Betriebstemperatur operating temperature		$T_{c,op}$		- 40...+125	$^\circ C$
Lagertemperatur storage temperature		T_{stg}		- 40...+130	$^\circ C$

Mechanische Eigenschaften / Mechanical properties

Gehäuse, siehe Anlage case, see appendix				Seite 3 page 3	
Si-Elemente mit Lötkontakt, glaspassiviert Si-pellets with soldered contact, glass-passivated					
Innere Isolation internal insulation				Al_2O_3	
Anzugsdrehmoment für mechanische Befestigung mounting torque	Toleranz / tolerance $\pm 15\%$	M1		6	Nm
Anzugsdrehmoment für elektrische Anschlüsse terminal connection torque	Toleranz / tolerance $+5\% / -10\%$	M2		6	Nm
Gewicht weight		G	typ.	300	g
Kriechstrecke creepage distance				12,5	mm
Schwingfestigkeit vibration resistance	$f = 50Hz$			50	m/s^2

Temperatursensor / Temperature sensor

Nennwiderstand rated resistance	$T_C = 25^\circ C$ $R_{100} = 493\Omega \pm 5\%$	R_{25}		5	$k\Omega$
Verlustleistung power dissipation	$T_C = 25^\circ C$	P_{25}	max.	20	mW

Kühlkörper / heatsinks : KM 11; KM 14; KM 17; KM 33

Mit dieser technischen Information werden Halbleiterbauelemente spezifiziert, jedoch keine Eigenschaften zugesichert. Sie gilt in Verbindung mit den zugehörigen Technischen Erläuterungen. / This technical information specifies semiconductor devices but promises no characteristics. It is valid in combination with the belonging technical notes.

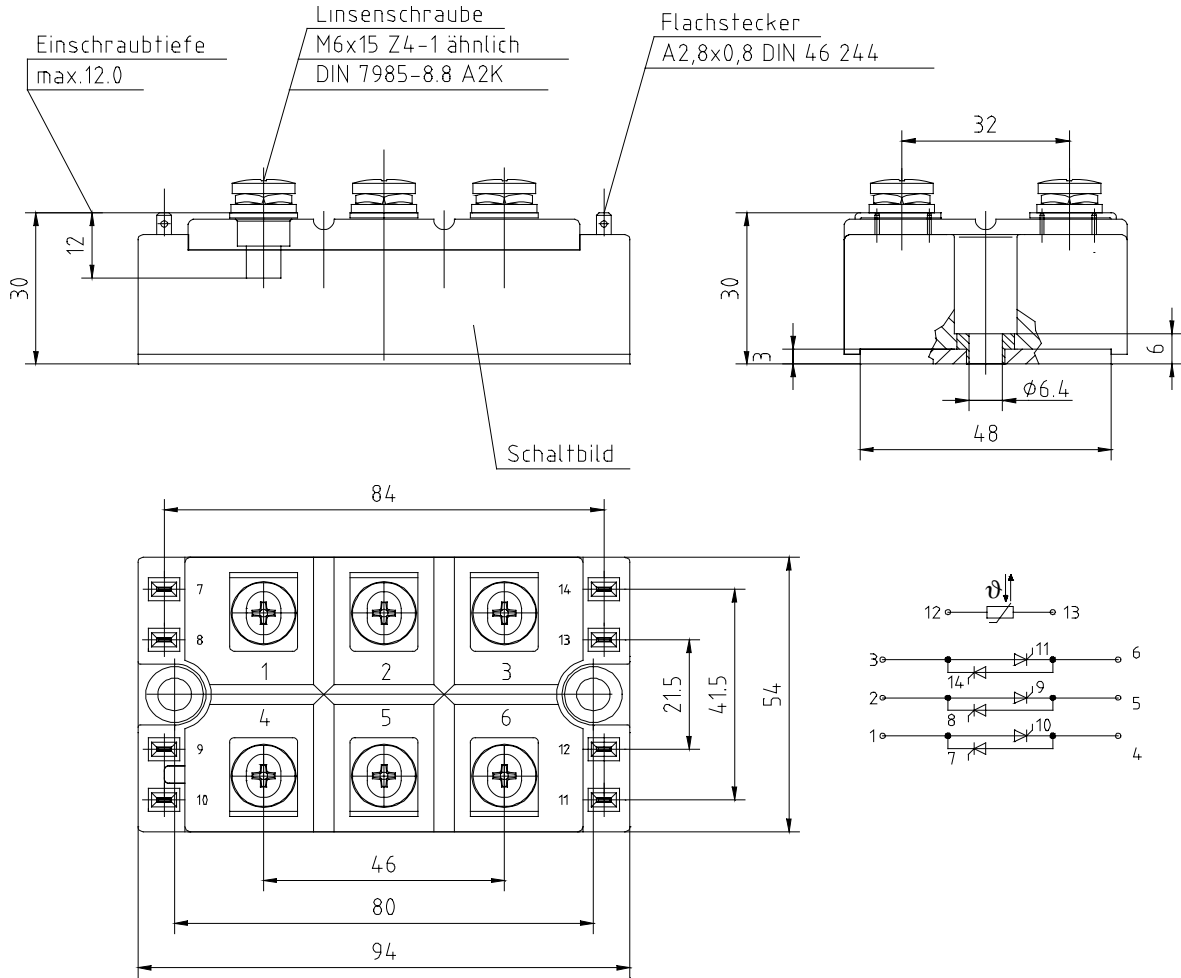

Analytische Elemente des transienten Wärmewiderstandes Z_{thJC} für DC

Analytical elements of transient thermal impedance Z_{thJC} for DC

Pos. n	1	2	3	4	5	6	7
$R_{thn} [^{\circ}C / W]$	0,25300	0,35100	0,04930				
$\tau_n [s]$	0,31800	0,03870	0,00109				

Analytische Funktion:
$$Z_{thJC} = \sum_{n=1}^{n_{max}} R_{thn} \left(1 - e^{-\frac{t}{\tau_n}} \right)$$

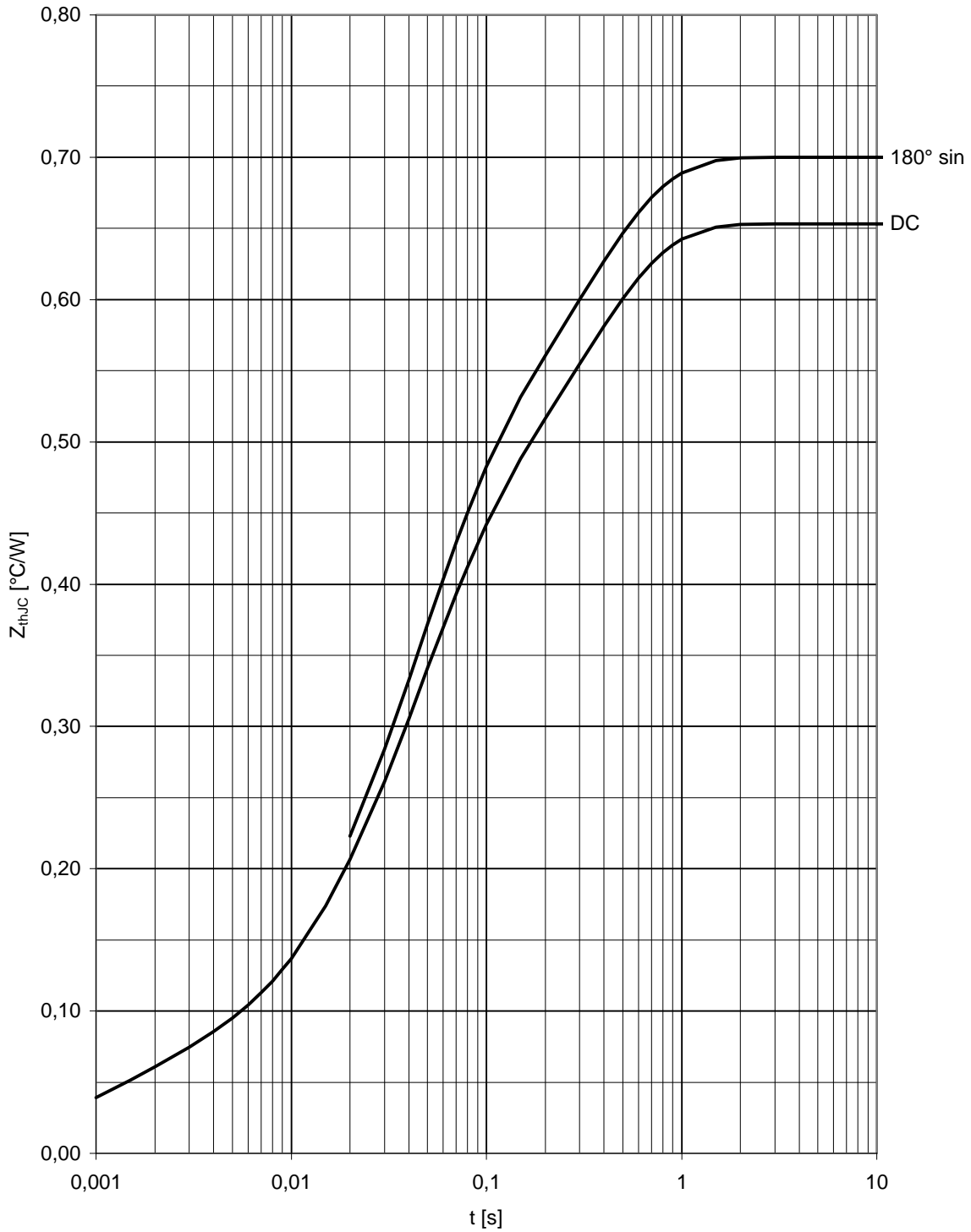

Transienter innerer Wärmewiderstand je Zweig / Transient thermal impedance per arm, $Z_{thjC} = f(t)$
Parameter: Stromflußwinkel / Current conduction angle α

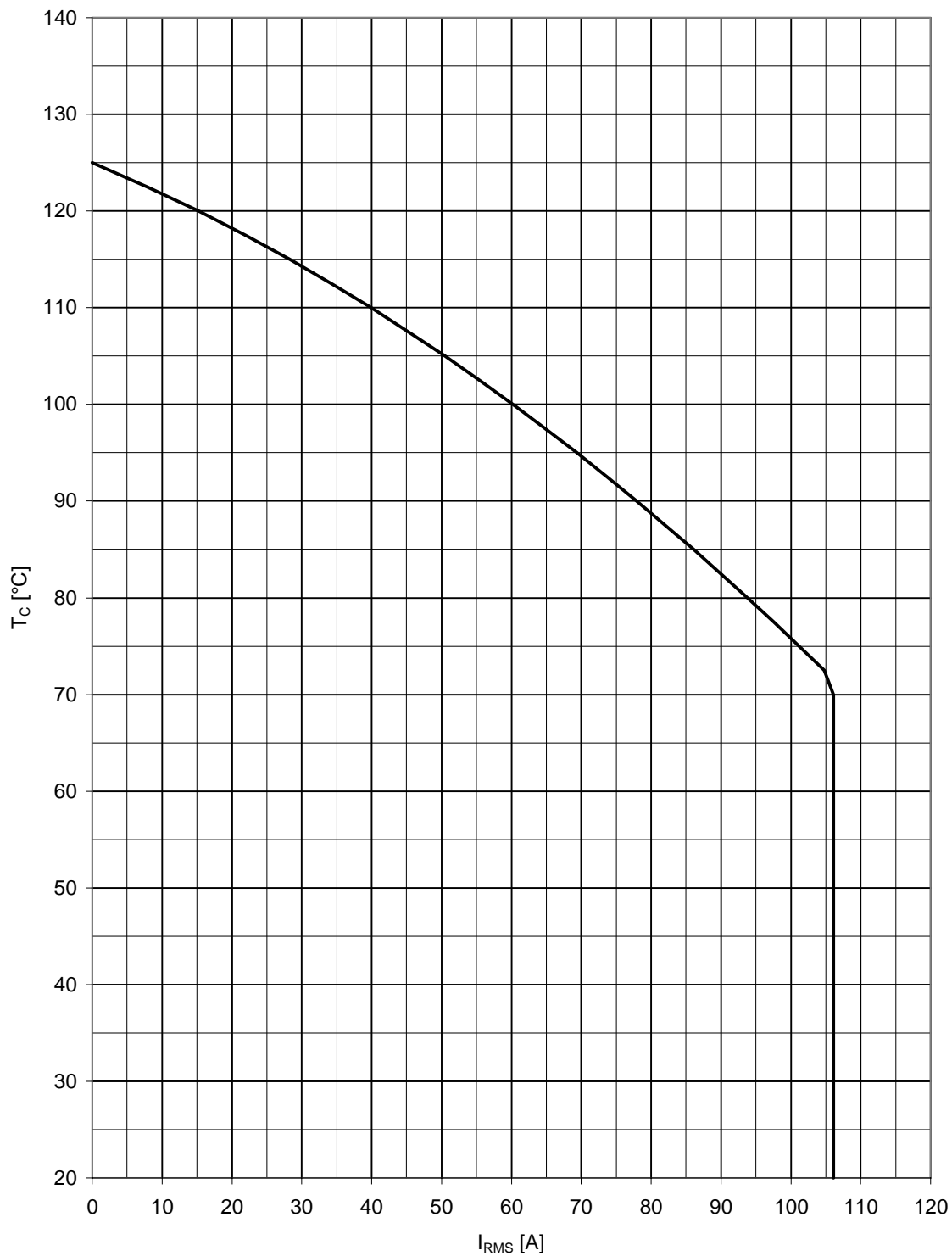

Höchstzulässige Gehäusetemperatur / Maximum allowable case temperature $T_c = f(I_{RMS})$

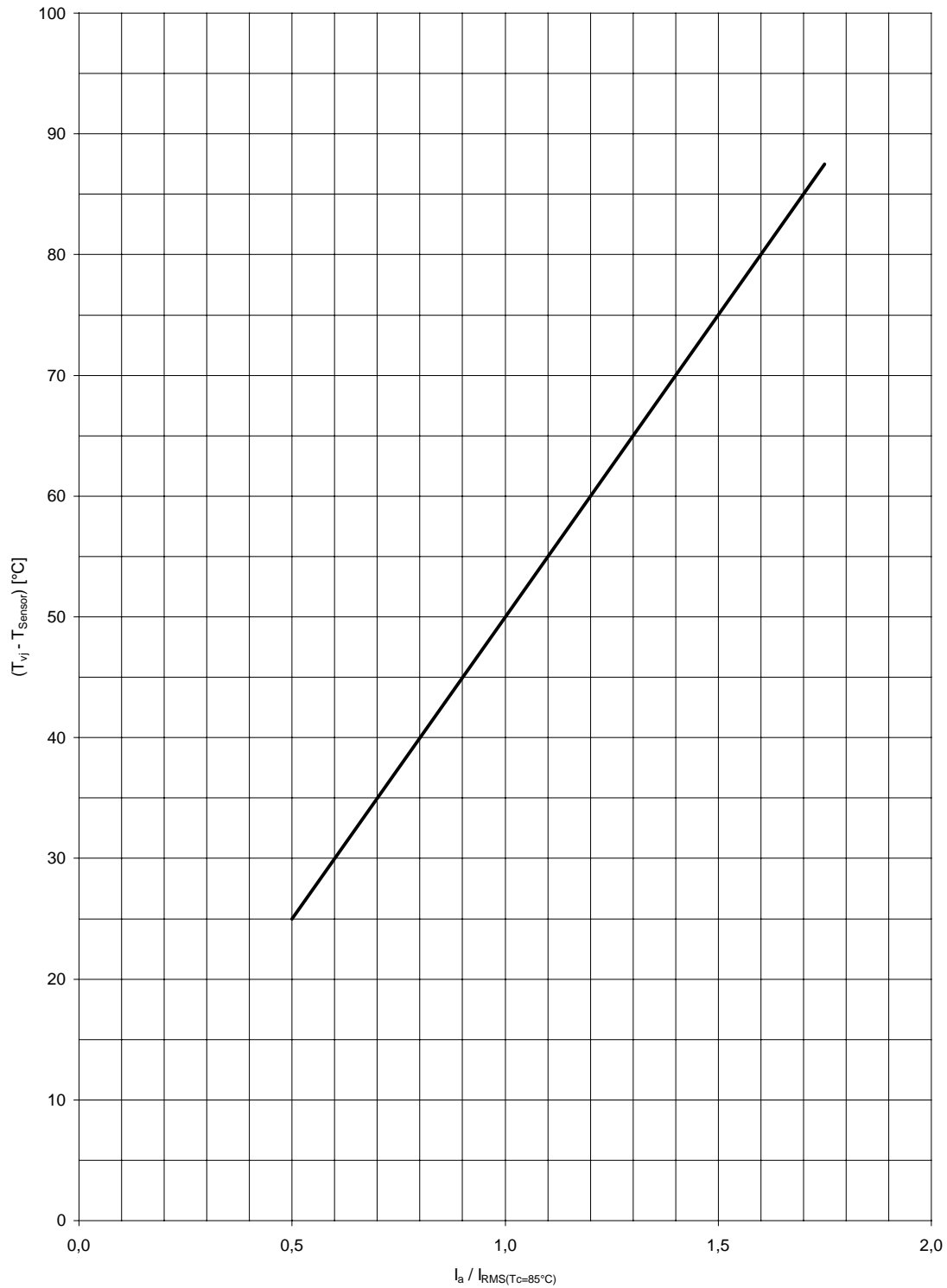

Differenz zwischen Sperrschicht- und Sensortemperatur / Difference between the values of junction and sensor temperature $(T_j - T_{Sensor}) = f(I_a / I_{RMS(T_c=85^\circ C)})$

I_a : Anlaufstrom / Starting current

I_{RMS} : Effektivstrom (pro Phase) / RMS current (per arm)

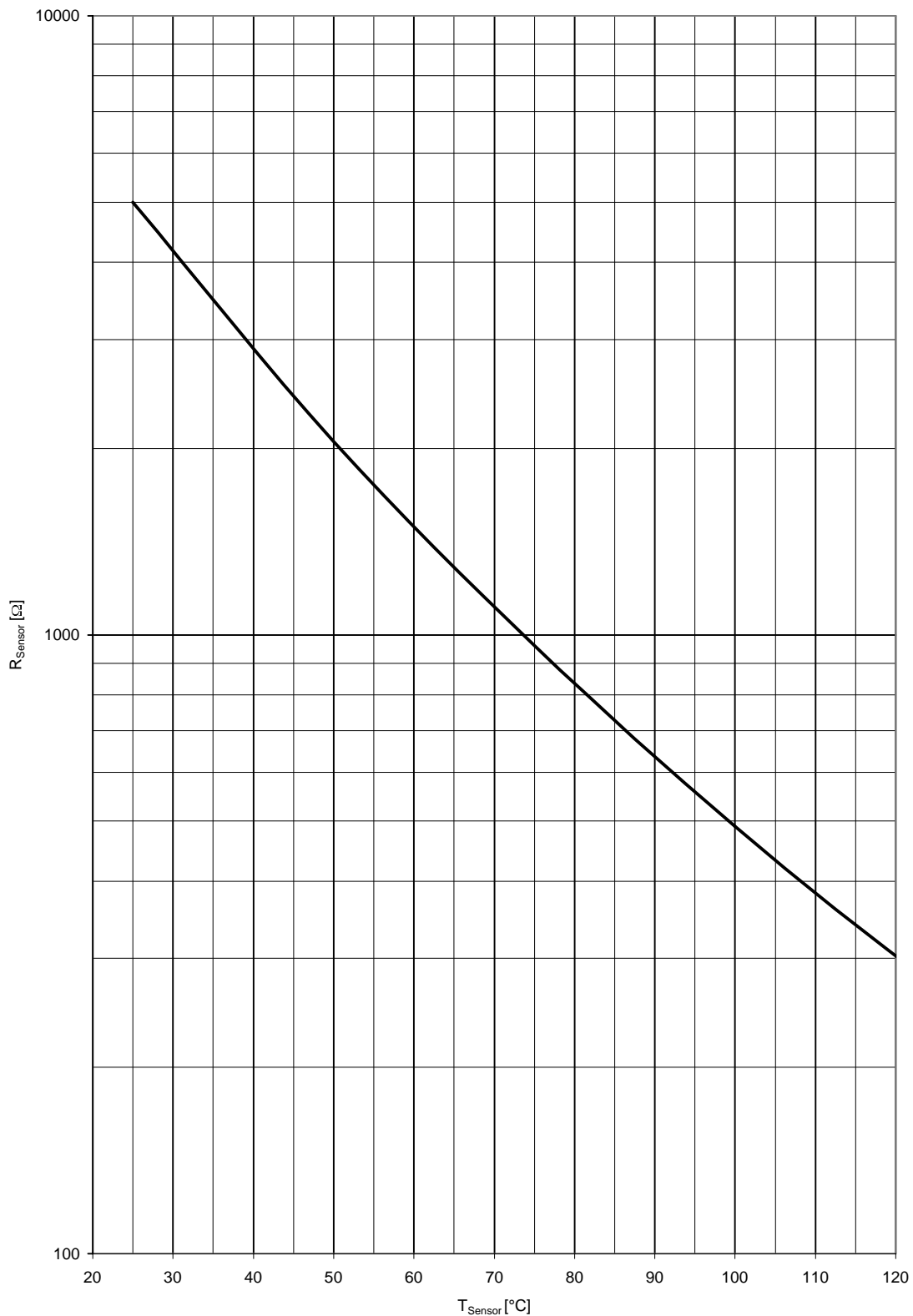

Sensorwiderstand / Sensor resistance $R_{Sensor} = f(T_{Sensor})$

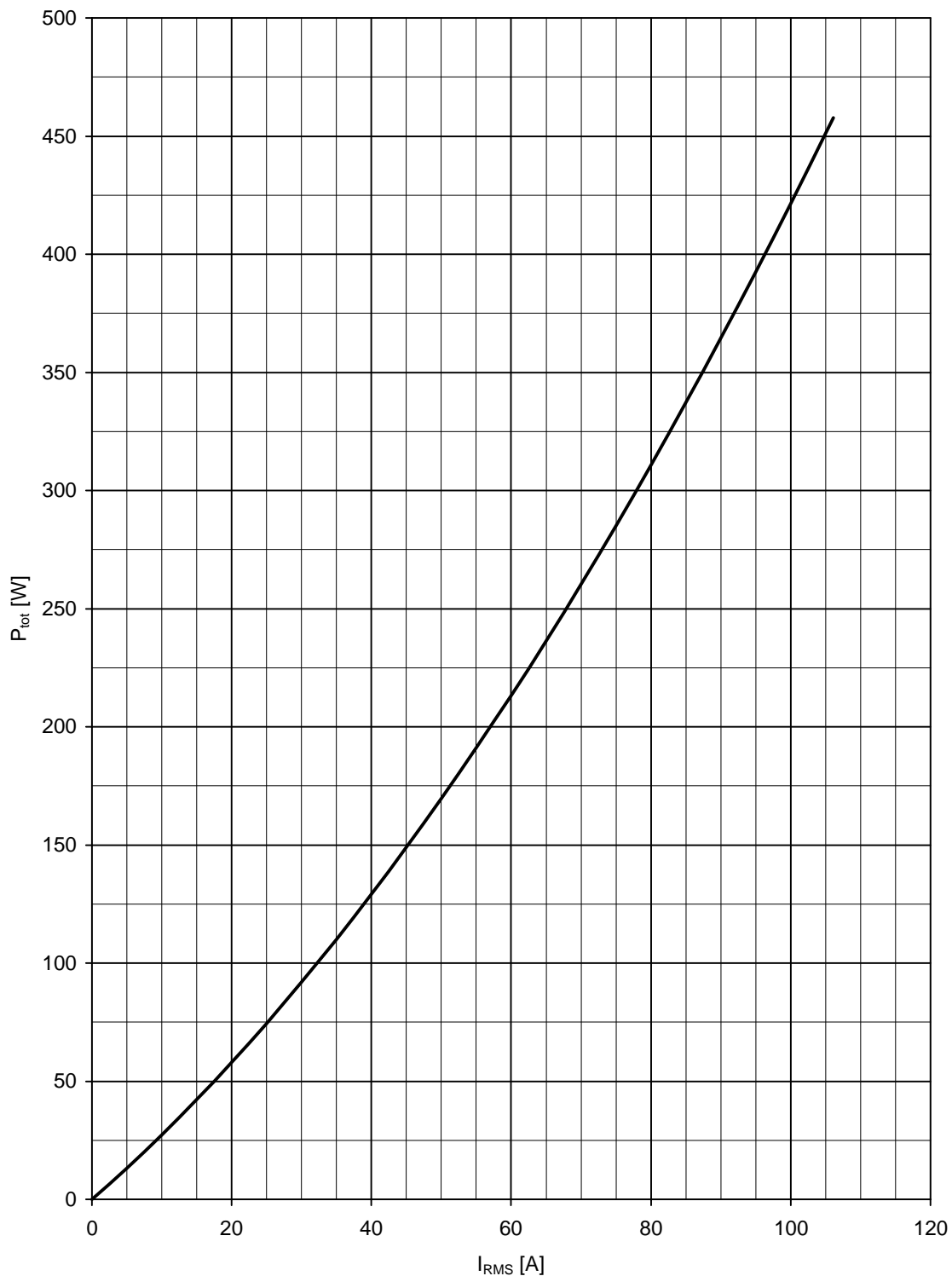

Gesamtverlustleistung pro Modul / Total power dissipation per module, $P = f(I_{RMS})$
 I_{RMS} : Effektivstrom (pro Phase) / RMS current (per arm)