

# Three Phase Rectifier Bridge

$I_{dAVM} = 38 \text{ A}$   
 $V_{RRM} = 1200-1800 \text{ V}$

$V_{RSM}$ V	$V_{RRM}$ V	Type
600	600	VUO 35-06NO7
1200	1200	VUO 35-12NO7
1400	1400	VUO 35-14NO7
1600	1600	VUO 35-16NO7
1800	1800	VUO 35-18NO7*

\* delivery time on request

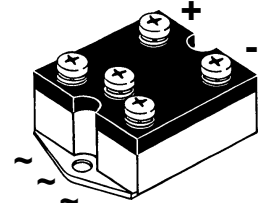
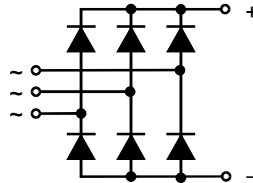

Symbol	Test Conditions	Maximum Ratings
$I_{dAVM}$	$T_C = 85^\circ\text{C}$ , module	38 A
$I_{FSM}$	$T_{VJ} = 45^\circ\text{C}$ ; $V_R = 0$	t = 10 ms (50 Hz), sine 400 A
		t = 8.3 ms (60 Hz), sine 440 A
$I^2t$	$T_{VJ} = T_{VJM}$ ; $V_R = 0$	t = 10 ms (50 Hz), sine 360 A
		t = 8.3 ms (60 Hz), sine 400 A
$I^2t$	$T_{VJ} = 45^\circ\text{C}$ ; $V_R = 0$	t = 10 ms (50 Hz), sine 800 A <sup>2</sup> s
		t = 8.3 ms (60 Hz), sine 810 A <sup>2</sup> s
$I^2t$	$T_{VJ} = T_{VJM}$ ; $V_R = 0$	t = 10 ms (50 Hz), sine 650 A <sup>2</sup> s
		t = 8.3 ms (60 Hz), sine 670 A <sup>2</sup> s
$T_{VJ}$		-40...+150 °C
$T_{VJM}$		150 °C
$T_{stg}$		-40...+150 °C
$V_{ISOL}$	50/60 Hz, RMS $I_{ISOL} \leq 1 \text{ mA}$	t = 1 min 2500 V~
		t = 1 s 3000 V~
$M_d$	Mounting torque (M4)	1.5 ± 15 % Nm
		13 ± 15 % lb.in.
$M_d$	Terminal connection torque (M4)	1.5 ± 15 % Nm
		13 ± 15 % lb.in.
Weight	typ.	135 g

### Features

- Package with screw terminals
- Isolation voltage 3000 V~
- Planar passivated chips
- Blocking voltage up to 1800 V
- Low forward voltage drop
- UL registered E 72873

### Applications

- Supplies for DC power equipment
- Input rectifiers for PWM inverter
- Battery DC power supplies
- Field supply for DC motors

### Advantages

- Easy to mount with two screws
- Space and weight savings
- Improved temperature and power cycling

### Dimensions in mm (1 mm = 0.0394")

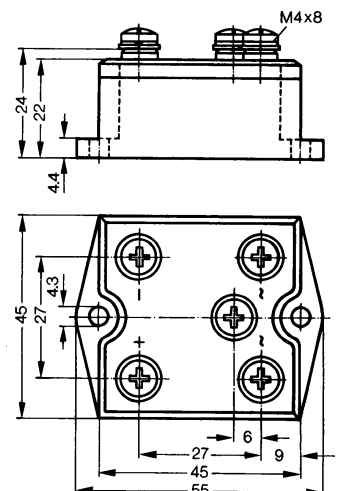

Symbol	Test Conditions	Characteristic Values
$I_R$	$V_R = V_{RRM}$ ; $T_{VJ} = 25^\circ\text{C}$	$\leq 0.3 \text{ mA}$
	$V_R = V_{RRM}$ ; $T_{VJ} = T_{VJM}$	$\leq 5.0 \text{ mA}$
$V_F$	$I_F = 150 \text{ A}$ ; $T_{VJ} = 25^\circ\text{C}$	$\leq 2.2 \text{ V}$
$V_{T0}$	For power-loss calculations only	0.85 V
$r_T$		12 mΩ
$R_{thJC}$	per diode; DC current	4.2 K/W
	per module	0.7 K/W
$R_{thJH}$	per diode; DC current	4.8 K/W
	per module	0.8 K/W

Data according to IEC 60747 and refer to a single diode unless otherwise stated. IXYS reserves the right to change limits, test conditions and dimensions.

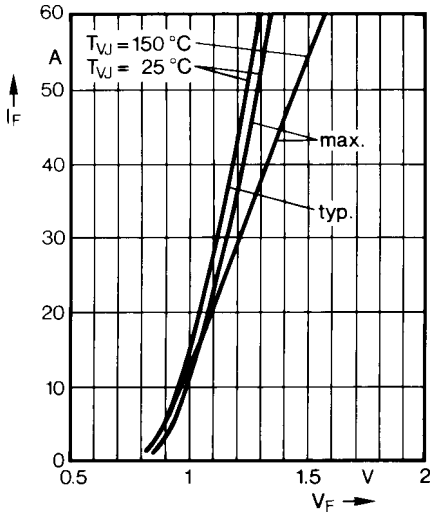

Fig. 1 Forward current versus voltage drop per diode

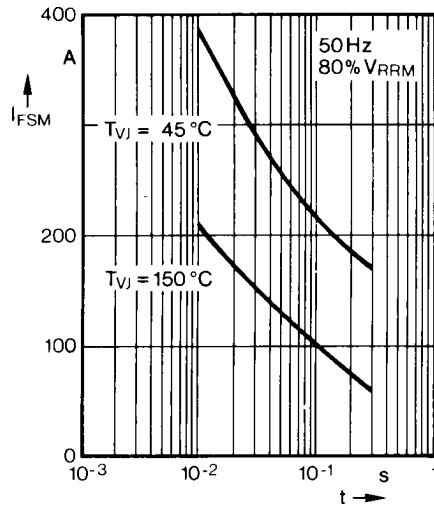

Fig. 2 Surge overload current per diode  
I<sub>FSM</sub>: Crest value. t: duration

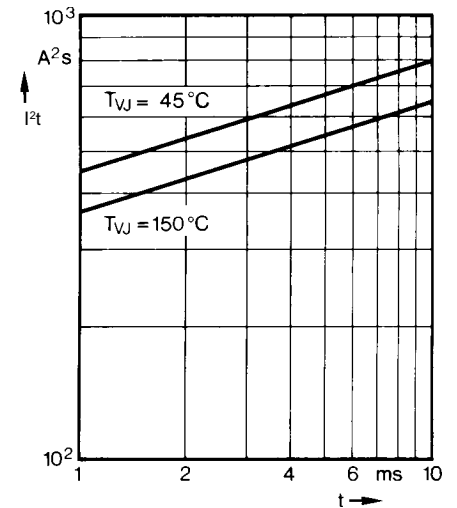

Fig. 3 I<sup>2</sup>t versus time (1-10 ms) per diode

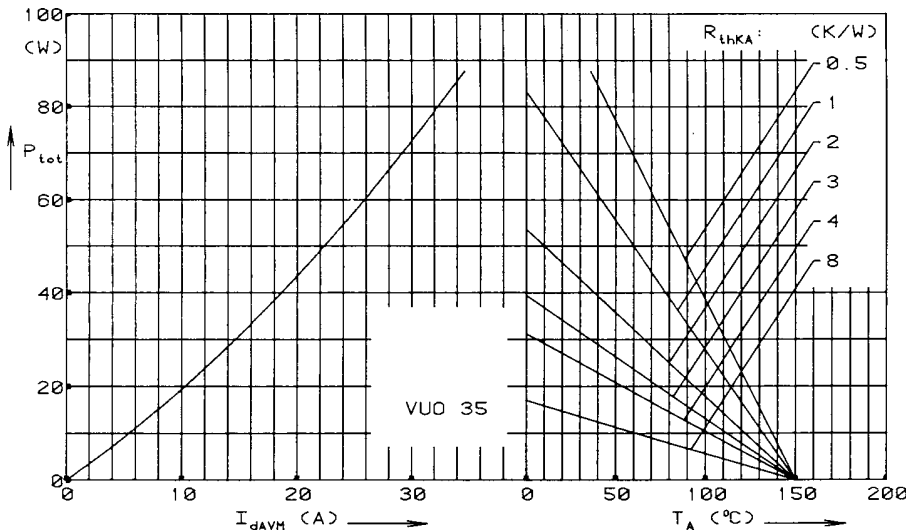

Fig. 4 Power dissipation versus direct output current and ambient temperature

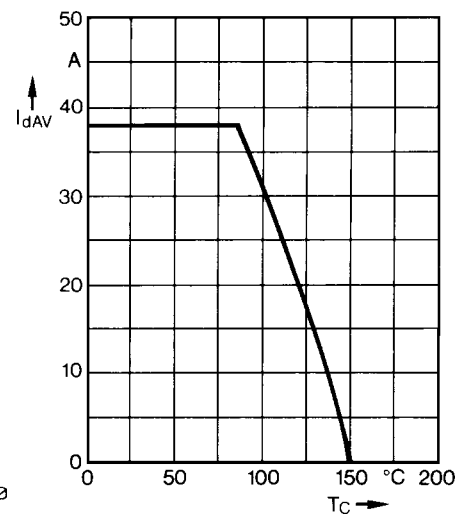

Fig. 5 Maximum forward current at case temperature

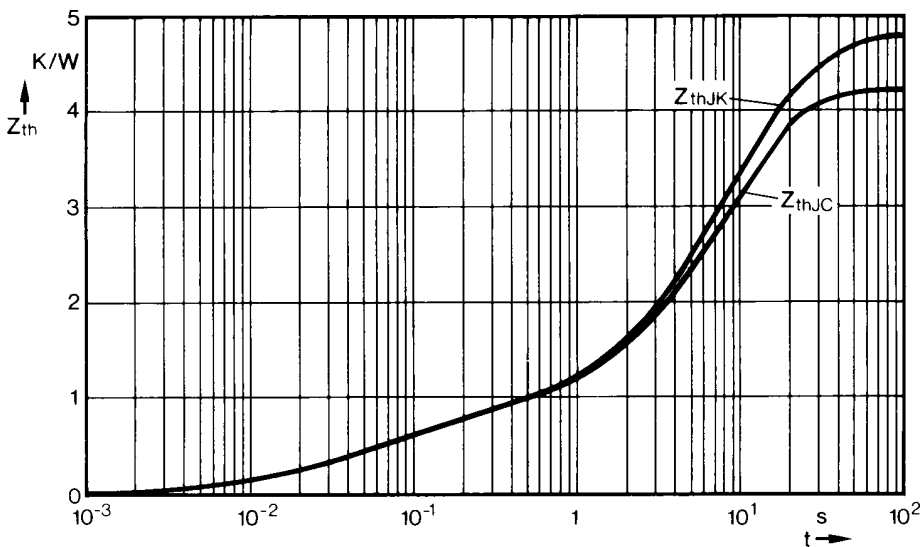

Fig. 6 Transient thermal impedance per diode

Constants for Z<sub>thJC</sub> calculation:

i	R <sub>thi</sub> (K/W)	t <sub>i</sub> (s)
1	0.194	0.024
2	0.556	0.07
3	0.45	3.25
4	3.0	9.3

Constants for Z<sub>thJK</sub> calculation:

i	R <sub>thi</sub> (K/W)	t <sub>i</sub> (s)
1	0.194	0.024
2	0.556	0.07
3	0.45	3.25
4	3.0	9.3
5	0.6	28.0