

# Three Phase Rectifier Bridge

**$I_{dAV} = 70 \text{ A}$**   
 **$V_{RRM} = 800-1600 \text{ V}$**

$V_{RSM}$ V	$V_{RRM}$ V	Types
900	800	VUO 70-08NO7
1300	1200	VUO 70-12NO7
1500	1400	VUO 70-14NO7
1700	1600	VUO 70-16NO7

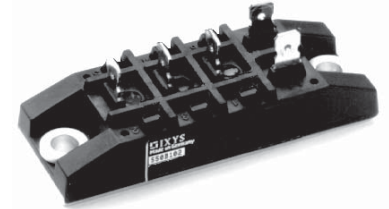
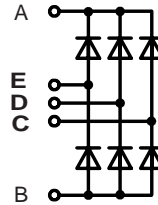

Symbol	Conditions	Maximum Ratings	
$I_{dAV}$ ①	$T_C = 100^\circ\text{C}$ , module	70	A
$I_{FSM}$	$T_{VJ} = 45^\circ\text{C}$ ; $V_R = 0$	$t = 10 \text{ ms}$ (50 Hz), sine	550 A
		$t = 8.3 \text{ ms}$ (60 Hz), sine	600 A
	$T_{VJ} = T_{VJM}$ $V_R = 0$	$t = 10 \text{ ms}$ (50 Hz), sine	500 A
		$t = 8.3 \text{ ms}$ (60 Hz), sine	550 A
$I^2t$	$T_{VJ} = 45^\circ\text{C}$ $V_R = 0$	$t = 10 \text{ ms}$ (50 Hz), sine	1520 A <sup>2</sup> s
		$t = 8.3 \text{ ms}$ (60 Hz), sine	1520 A <sup>2</sup> s
	$T_{VJ} = T_{VJM}$ $V_R = 0$	$t = 10 \text{ ms}$ (50 Hz), sine	1250 A <sup>2</sup> s
		$t = 8.3 \text{ ms}$ (60 Hz), sine	1250 A <sup>2</sup> s
$T_{VJ}$		-40...+150	$^\circ\text{C}$
$T_{VJM}$		150	$^\circ\text{C}$
$T_{stg}$		-40...+125	$^\circ\text{C}$
$V_{ISOL}$	50/60 Hz, RMS $I_{ISOL} \leq 1 \text{ mA}$	$t = 1 \text{ min}$	2500 V~
		$t = 1 \text{ s}$	3000 V~
$M_d$	Mounting torque (M5) (10-32 UNF)	$5 \pm 15 \%$	Nm
		$44 \pm 15 \%$	lb.in.
Weight	typ.	110	g

## Features

- Package with copper base plate
- Isolation voltage 3000 V~
- Planar passivated chips
- Low forward voltage drop
- 1/4" fast-on power terminals

## Applications

- Supplies for DC power equipment
- Input rectifiers for PWM inverter
- Battery DC power supplies
- Field supply for DC motors

## Advantages

- Easy to mount with two screws
- Space and weight savings
- Improved temperature and power cycling capability
- Small and light weight

Symbol	Conditions	Characteristic Values	
$I_R$	$V_R = V_{RRM}$ ; $V_R = V_{RRM}$	$T_{VJ} = 25^\circ\text{C}$	$\leq 0.5 \text{ mA}$
		$T_{VJ} = T_{VJM}$	$\leq 10 \text{ mA}$
$V_F$	$I_F = 150 \text{ A}$ ; $T_{VJ} = 25^\circ\text{C}$	$\leq$	1.7 V
$V_{T0}$	For power-loss calculations only		0.8 V
$r_T$			8 m $\Omega$
$R_{thJC}$	per diode; DC current per module		1.45 KW
			0.242 KW
$R_{thJH}$	per diode, DC current per module		1.9 KW
			0.317 KW
$d_s$	Creeping distance on surface		16.1 mm
$d_A$	Creepage distance in air		7.5 mm
$a$	Max. allowable acceleration		50 m/s <sup>2</sup>

## Dimensions in mm (1 mm = 0.0394")

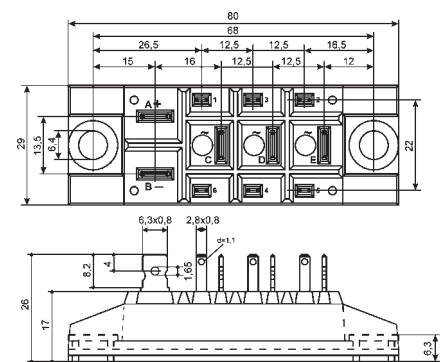

Data according to IEC 60747 refer to a single diode unless otherwise stated

① for resistive load at bridge output. IXYS reserves the right to change limits, test conditions and dimensions.

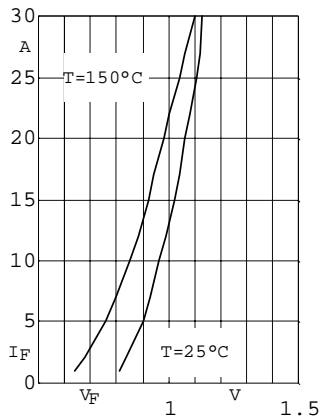

Fig. 1 Forward current versus voltage drop per diode

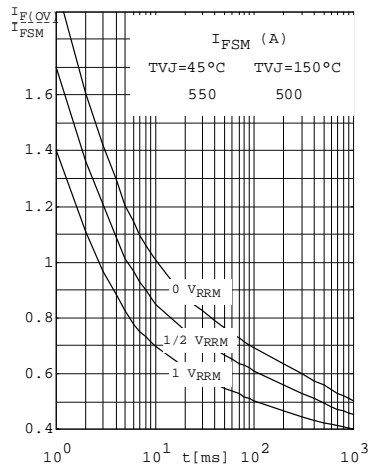

Fig. 2 Surge overload current per diode  
 $I_{FSM}$ : Crest value.  $t$ : duration

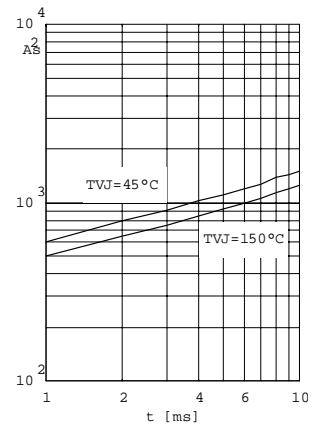

Fig. 3  $i^2dt$  versus time (1-10ms) per diode or thyristor

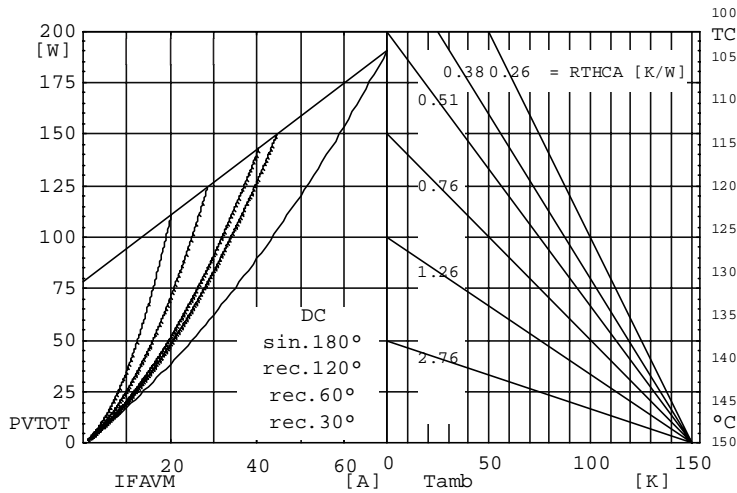

Fig. 4 Power dissipation versus direct output current and ambient temperature

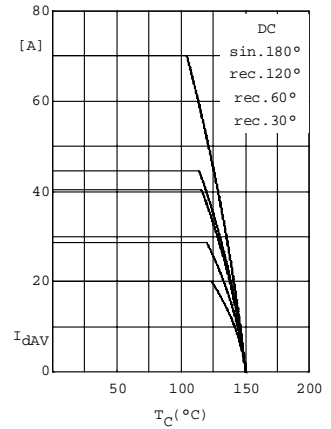

Fig. 5 Maximum forward current at case temperature

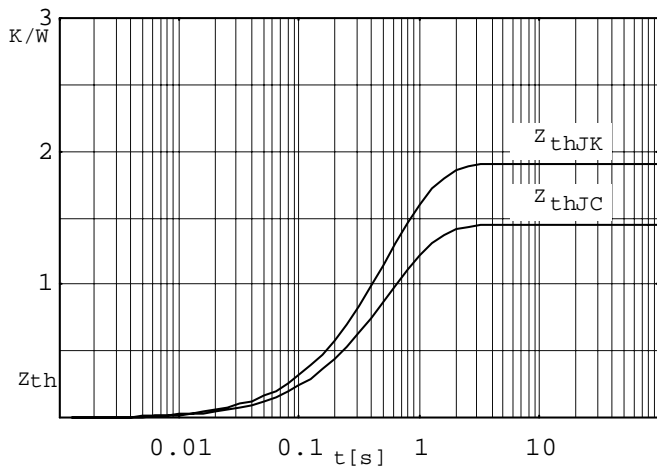

Fig. 6 Transient thermal impedance per diode or Thyristor, calculated