

Three Phase Rectifier Bridge

$I_{dAV} = 70 \text{ A}$
 $V_{RRM} = 800-1600 \text{ V}$

V_{RSM} V	V_{RRM} V	Types
900	800	VUO 70-08NO7
1300	1200	VUO 70-12NO7
1500	1400	VUO 70-14NO7
1700	1600	VUO 70-16NO7

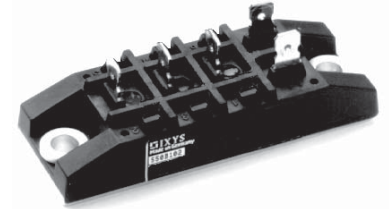
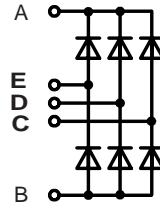

Symbol	Conditions	Maximum Ratings	
I_{dAV} ①	$T_C = 100^\circ\text{C}$, module	70	A
I_{FSM}	$T_{VJ} = 45^\circ\text{C}$; $V_R = 0$	$t = 10 \text{ ms}$ (50 Hz), sine	550 A
		$t = 8.3 \text{ ms}$ (60 Hz), sine	600 A
	$T_{VJ} = T_{VJM}$ $V_R = 0$	$t = 10 \text{ ms}$ (50 Hz), sine	500 A
		$t = 8.3 \text{ ms}$ (60 Hz), sine	550 A
I^2t	$T_{VJ} = 45^\circ\text{C}$ $V_R = 0$	$t = 10 \text{ ms}$ (50 Hz), sine	1520 A ² s
		$t = 8.3 \text{ ms}$ (60 Hz), sine	1520 A ² s
	$T_{VJ} = T_{VJM}$ $V_R = 0$	$t = 10 \text{ ms}$ (50 Hz), sine	1250 A ² s
		$t = 8.3 \text{ ms}$ (60 Hz), sine	1250 A ² s
T_{VJ}		-40...+150	°C
T_{VJM}		150	°C
T_{stg}		-40...+125	°C
V_{ISOL}	50/60 Hz, RMS $I_{ISOL} \leq 1 \text{ mA}$	$t = 1 \text{ min}$	2500 V~
		$t = 1 \text{ s}$	3000 V~
M_d	Mounting torque (M5) (10-32 UNF)	$5 \pm 15 \%$	Nm
		$44 \pm 15 \%$	lb.in.
Weight	typ.	110	g

Features

- Package with copper base plate
- Isolation voltage 3000 V~
- Planar passivated chips
- Low forward voltage drop
- ¼" fast-on power terminals

Applications

- Supplies for DC power equipment
- Input rectifiers for PWM inverter
- Battery DC power supplies
- Field supply for DC motors

Advantages

- Easy to mount with two screws
- Space and weight savings
- Improved temperature and power cycling capability
- Small and light weight

Symbol	Conditions	Characteristic Values	
I_R	$V_R = V_{RRM}$; $V_R = V_{RRM}$	$T_{VJ} = 25^\circ\text{C}$	$\leq 0.5 \text{ mA}$
		$T_{VJ} = T_{VJM}$	$\leq 10 \text{ mA}$
V_F	$I_F = 150 \text{ A}$; $T_{VJ} = 25^\circ\text{C}$	\leq	1.7 V
V_{T0}	For power-loss calculations only		0.8 V
r_T			8 mΩ
R_{thJC}	per diode; DC current per module		1.45 KW
			0.242 KW
R_{thJH}	per diode, DC current per module		1.9 KW
			0.317 KW
d_s	Creeping distance on surface	16.1	mm
d_A	Creepage distance in air	7.5	mm
a	Max. allowable acceleration	50	m/s ²

Dimensions in mm (1 mm = 0.0394")

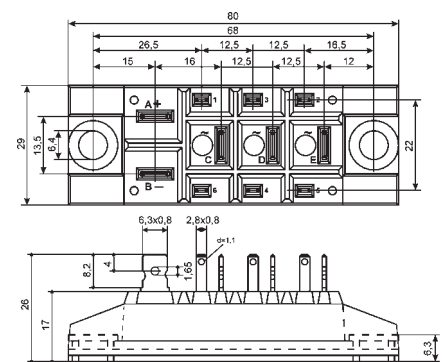

Data according to IEC 60747 refer to a single diode unless otherwise stated

① for resistive load at bridge output. IXYS reserves the right to change limits, test conditions and dimensions.

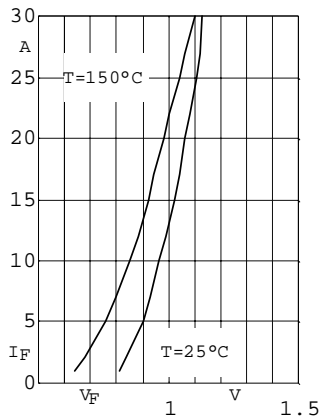

Fig. 1 Forward current versus voltage drop per diode

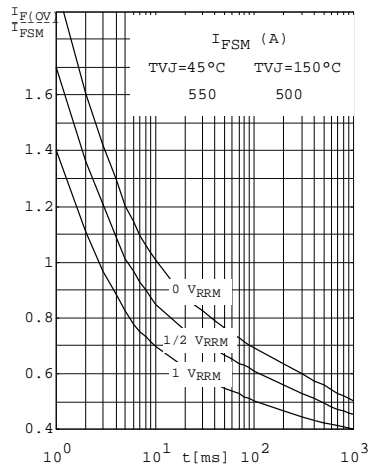

Fig. 2 Surge overload current per diode I_{FSM} : Crest value. t : duration

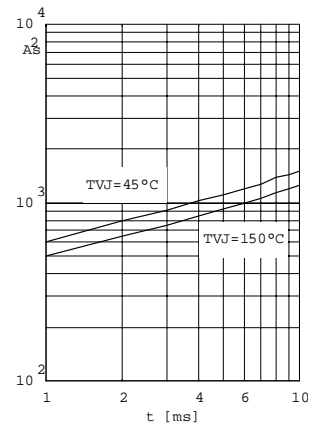

Fig. 3 i^2dt versus time (1-10ms) per diode or thyristor

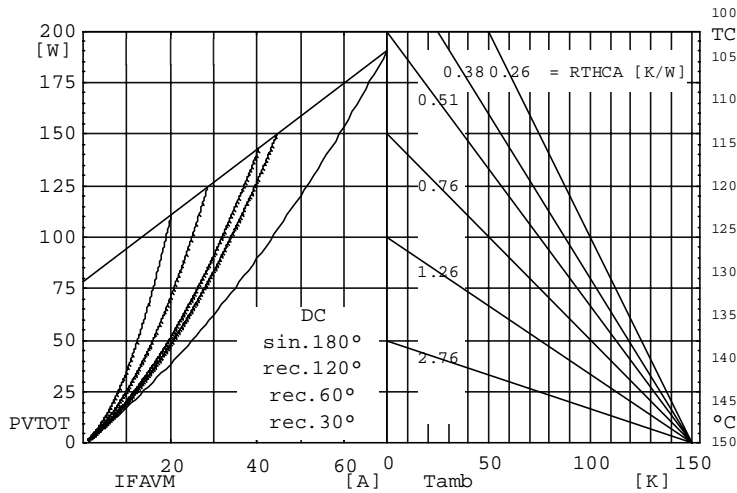

Fig. 4 Power dissipation versus direct output current and ambient temperature

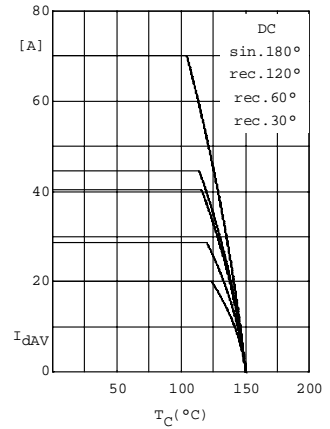

Fig.5 Maximum forward current at case temperature

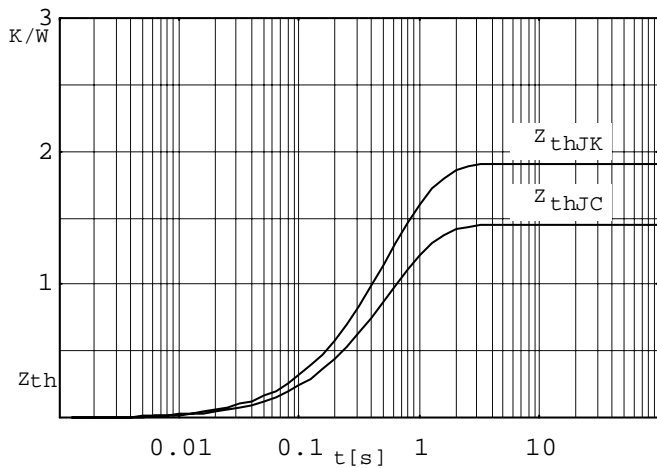

Fig. 6 Transient thermal impedance per diode or Thyristor, calculated