

低損失超高速ダイオード

LOW LOSS SUPER HIGH SPEED RECTIFIER

■特長：Features

- 取り付け面が絶縁されたフルモールドタイプ
Insulated package by fully molding.
- 低 V_F
Low V_F
- スイッチングスピードが非常に速い
Super high speed switching.
- プレーナー技術による高信頼性
High reliability by planer design.

■用途：Applications

- 高速電力スイッチング
High speed power switching.

■定格と特性：Maximum Ratings and Characteristics

●絶対最大定格：Absolute Maximum Ratings

Items	Symbols	Conditions	Ratings	Units
ピーク繰り返し逆電圧 Repetitive Peak Reverse Voltage	V_{RRM}		200	V
平均出力電流 Average Output Current	I_O	方形波, duty = 1/2, $T_c = 115^\circ\text{C}$ Square wave	10*	A
サージ電流 Surge Current	I_{FSM}	正弦波 Sine wave 10ms	50	A
接合温度 Operating Junction Temperature	T_j		-40 ~ +150	$^\circ\text{C}$
保存温度 Storage Temperature	T_{stg}		-40 ~ +150	$^\circ\text{C}$

* センタータップ平均出力電流

* average forward current of centertap full wave connection

●電気的特性(特に指定がない限り周囲温度 $T_a = 25^\circ\text{C}$ とする)

Electrical Characteristics ($T_a = 25^\circ\text{C}$ Unless otherwise specified)

Items	Symbols	Conditions	Max.	Units
順電圧 Forward Voltage Drop	V_{FM}	$I_{FM} = 5.0\text{A}$	0.95	V
逆電流 Reverse Current	I_{RRM}	$V_R = V_{RRM}$	100	μA
逆回復時間 Reverse Recovery Time	t_{rr}	$I_F = 0.1\text{A}, I_R = 0.2\text{A}, I_{rec} = 0.05\text{A}$	35	ns
熱抵抗 Thermal Resistance	$R_{th(j-c)}$	接合・ケース間 Junction to case	3.5	$^\circ\text{C}/\text{W}$

■外形寸法：Outline Drawings

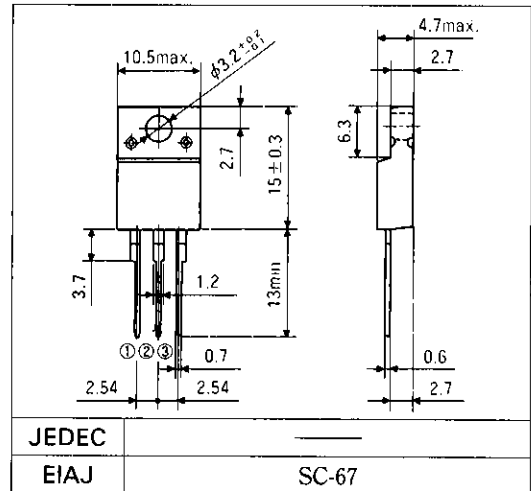

■電極接続

Connection Diagram

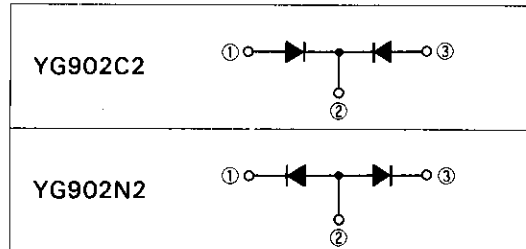

A

■特性曲線：Characteristics

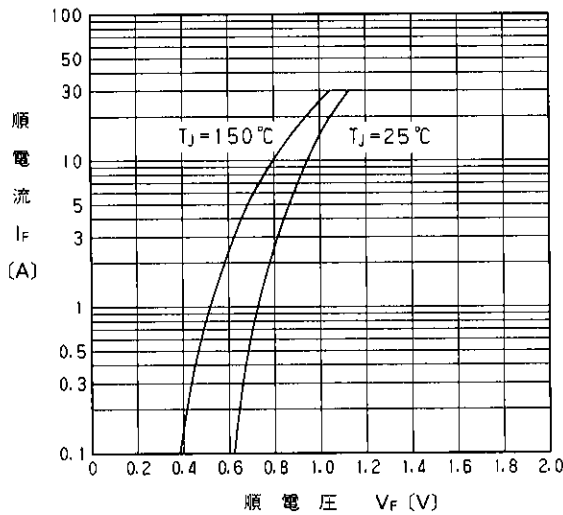

順特性(代表特性)
Forward Characteristics

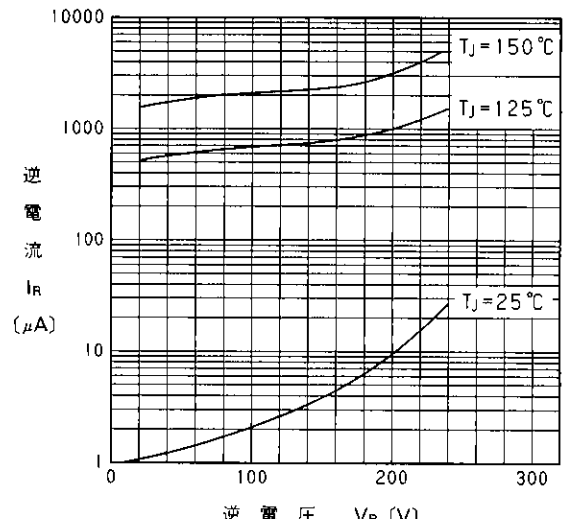

逆特性(代表特性)
Reverse Characteristics

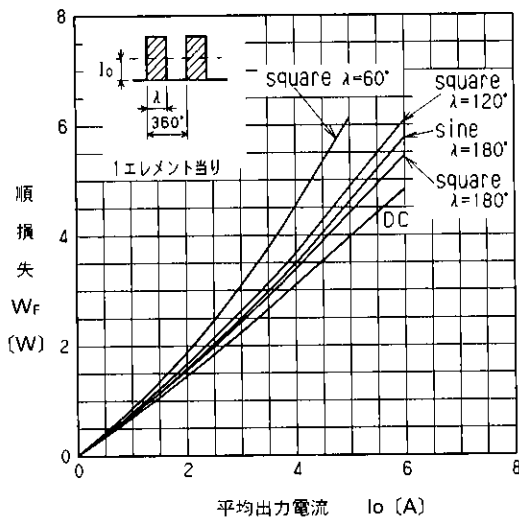

順損失特性
Forward Power Dissipation

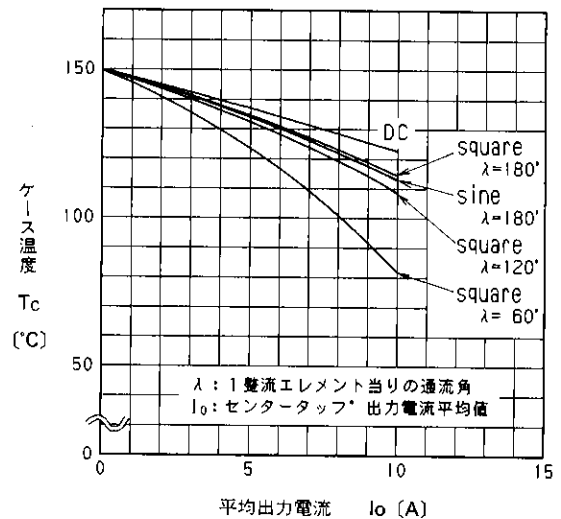

平均出力電流-ケース温度特性
Average Output Current-Case Temperature

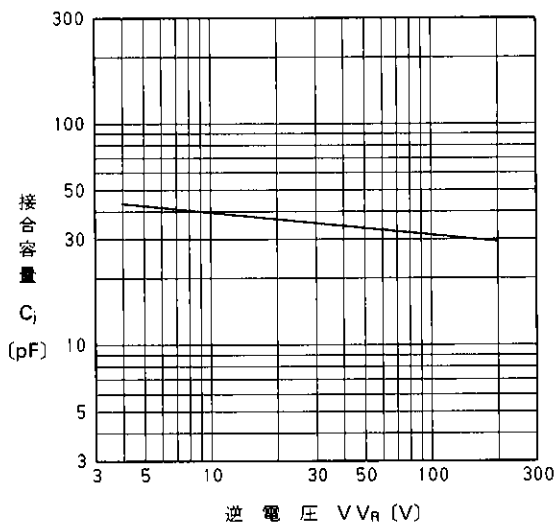

接合容量特性(代表特性)
Junction Capacitance Characteristics

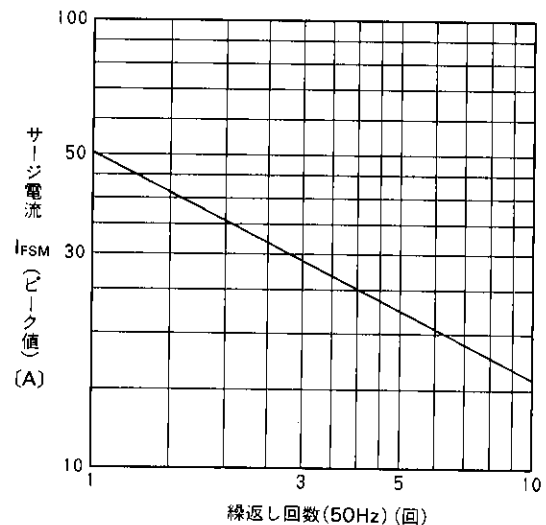

サージ電流耐量
Surge Capacity

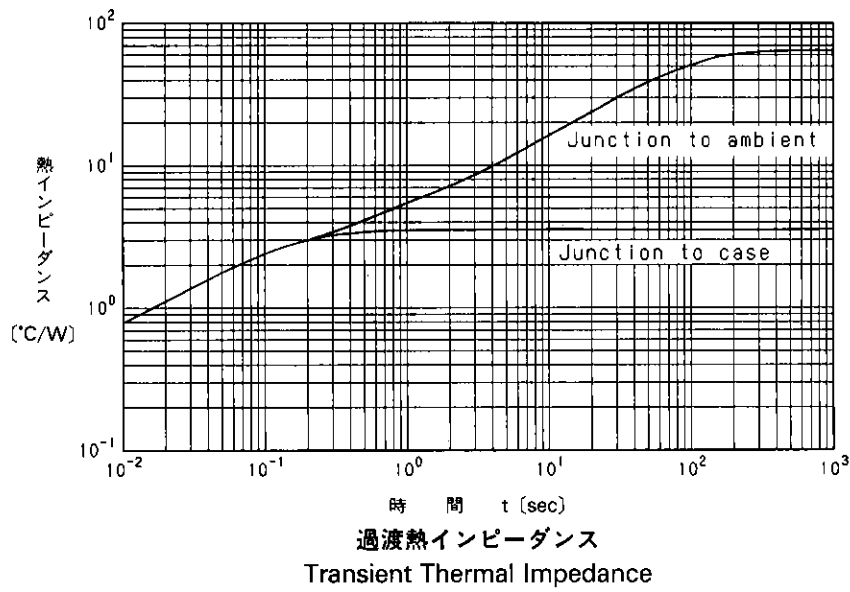

A